



**VFD-C2000**  
***PROFINET Communication Card***

**Operation Manual**



## Caution

- ✓ This operation manual provides information on specifications, installation instructions, basic operations/configurations, and details on network communication protocols.
- ✓ The AC motor drive is a sophisticated product powered by electricity. For the safety of the operator and your mechanical equipment, only qualified electrical engineers are allowed to perform the installation/test runs and make parameter adjustments. If you have any question or concern, please contact your local Delta distributor. Our professional staff will be very glad to help you.
- ✓ Please read this manual carefully and follow the instructions completely to avoid device damage or personal injury.

# Table of Contents

<b>1</b>	<b>Introduction .....</b>	<b>4</b>
1.1	Introduction to PROFINET IO Communication .....	4
1.2	Features .....	4
1.3	Network Functions and Specifications .....	4
<b>2</b>	<b>Product Appearance and Components .....</b>	<b>6</b>
2.1	Exterior Dimensions .....	6
2.2	Introduction to Each Component .....	6
2.3	LED Indicators .....	7
2.4	Definition of RJ45 Pin .....	7
2.5	MAC Address Label .....	8
<b>3</b>	<b>Installation and Wiring .....</b>	<b>9</b>
3.1	Installation .....	9
3.2	Unloading .....	9
3.3	Connecting to the Network .....	10
<b>4</b>	<b>VFD-C2000 Drive Settings .....</b>	<b>11</b>
<b>5</b>	<b>PROFINET Communication Profile .....</b>	<b>12</b>
5.1	Synchronous Parameter Access in Delta-specific Mode (Tables for Control Word and Status Word) .....	12
5.2	Asynchronous Parameter Access .....	16
5.3	Identification and Maintenance Functions (I&M) .....	17
5.4	Disconnection Treatment .....	17
<b>6</b>	<b>Connection Configuration to Host Controller .....</b>	<b>18</b>
6.1	Basic Configuration .....	18
6.2	Speed Mode DEMO (S7-300 + STEP 7) .....	23
6.3	Speed Mode DEMO (S7-1500 + TIA PORTAL) .....	33
6.4	Demonstration of Reading/Writing Synchronous and Asynchronous Parameters (S7-300 + TIA PORTAL) .....	42

# 1 Introduction

## 1.1 Introduction to PROFINET IO Communication

PROFINET IO is a fieldbus, a family of industrial computer network protocols, and serves as a communication between programmable logic controllers (PLC) and distributed field equipment for EtherNet. This protocol recognizes three classes of devices, IO Controllers, IO Supervisors and IO Devices, and uses three different communication channels to exchange data: Standard UDP/IP & TCP/IP Channel, Real-Time (RT) Channel, and Isochronous Real-Time (IRT) Channel. **Standard UDP/IP & TCP/IP Channel** is used to parameterize and configure device and asynchronous operation; **RT Channel** is used for synchronous data transmission and warning; **IRT Channel** is applied to motion control.

## 1.2 Features

CMC-PN01 connects C2000 drive to PROFINET to exchange data with the host controller easily. This simple network solution saves cost and time for connection and installation of factory automation. Moreover, its components are compatible with suppliers'.

By installing CMC-PN01 in C2000 through the main PROFINET device, you can:

1. Control the drive through PROFINET
2. Modify the drive's parameters through PROFINET
3. Monitor the drive's status through PROFINET

## 1.3 Network Functions and Specifications

### ■ EtherNet Specifications

Item	Specifications
Interface	RJ45
Number of ports	2 ports
Communication Mode	IEEE 802.3
Cable	Category 5e shielding 100 M
Transmission speed	10/100 Mbps auto-negotiate
Communication protocol	PROFINET

### ■ Environmental Conditions

Item	Specifications
Noise immunity	ESD (IEC 61800-5-1, IEC 6100-4-2) EFT (IEC 61800-5-1, IEC 6100-4-4) Surge Teat (IEC 61800-5-1, IEC 6100-4-5) Conducted Susceptibility Test (IEC 61800-5-1, IEC 6100-4-6)
Operating temperature	-10–50°C (temperature), 90% (humidity)
Storage temperature	-25–70°C (temperature), 95% (humidity)
Vibration/Shock resistance	International standards IEC 61800-5-1, IEC 60068-2-6/IEC 61800-5-1, IEC 60068-2-27



## ■ Electrical Specifications

Item	Specifications
Power supply voltage	5 V <sub>DC</sub>
Power consumption	0.8 W
Insulation voltage	500 V <sub>DC</sub>
Weight (g; approx.)	27 (g)

## 2 Product Appearance and Components

### 2.1 Exterior Dimensions

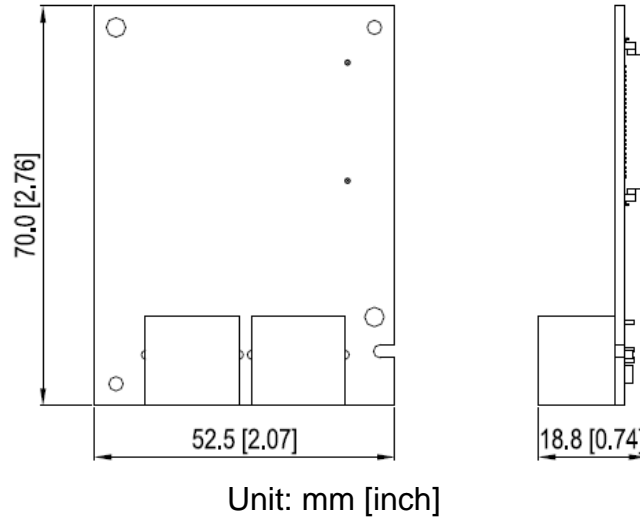

### 2.2 Introduction to Each Component

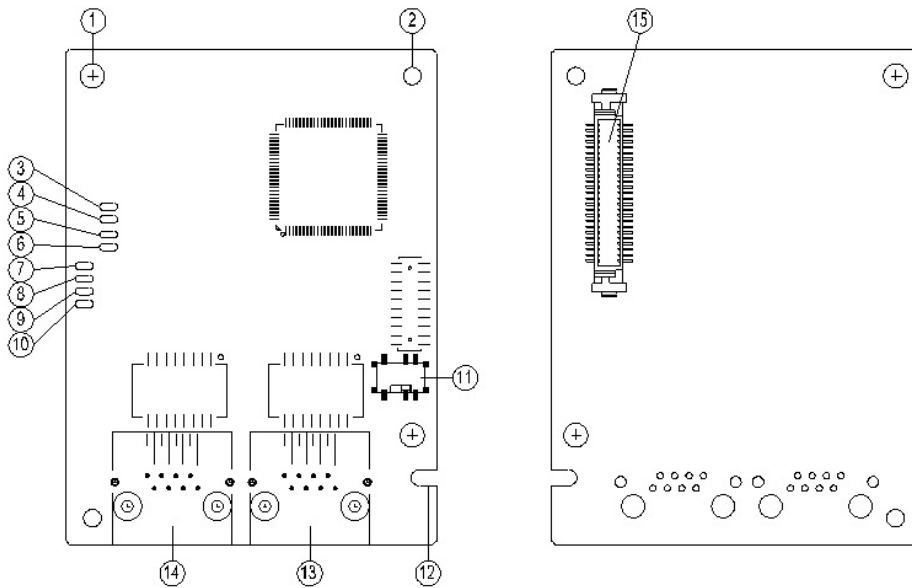

1. Screw fastening hole	9. ACT PHY1 indicator (Port 1)
2. Positioning hole for communication card	10. Link PHY1 indicator (Port 1)
3. Ready out indicator	11. ON/OFF Switch
4. MT out indicator	12. Fool-proof groove on the communication card
5. SD indicator	13. RJ45 connection port (Port 2)
6. BF out indicator	14. RJ45 connection port (Port 1)
7. ACT PHY2 indicator (Port 2)	15. Control panel connection port
8. Link PHY2 indicator (Port 2)	

## 2.3 LED Indicators

Name	Indicator Status	Indication	
Ready out indicator	Yellow LED	Always on	PN Stack normal activation
		Flashing	PN Stack normal activation, waiting for synchronizing with MCU.
		Off	PN Stack abnormal activation
MT out indicator	Green LED	-	-
SD indicator	Red LED	-	-
BF out indicator	Red LED	Always on	Disconnected with PROFINET Controller
		Flashing	Normal connection, but abnormal communication with PROFINET Controller.
		Off	Normal connection with PROFINET Controller
ACT PHY1 indicator	Orange LED	Always on	Connected and is exchanging data with Master regularly
		Flashing	Not connected but is handshaking data with Master
		Off	Initial status
LINK PHY1 indicator	Green LED	Always on	Normal network connection
		Off	Not connected to network
ACT PHY2 indicator	Orange LED	Always on	Connected and is exchanging data with Master regularly
		Flashing	Not connected but is handshaking data with Master
		Off	Initial status
LINK PHY2 indicator	Green LED	Always on	Normal network connection
		Off	Not connected to network

## 2.4 Definition of RJ45 Pin

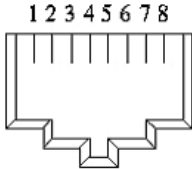
RJ45 Pinout Diagram	PIN	Definition	Description
	1	Tx+	Positive pole for data transmission
	2	Tx-	Negative pole for data transmission
	3	Rx+	Positive pole for receiving data
	4	--	N/C
	5	--	N/C
	6	Rx-	Negative pole for receiving data
	7	--	N/C
	8	--	N/C

## 2.5 MAC Address Label

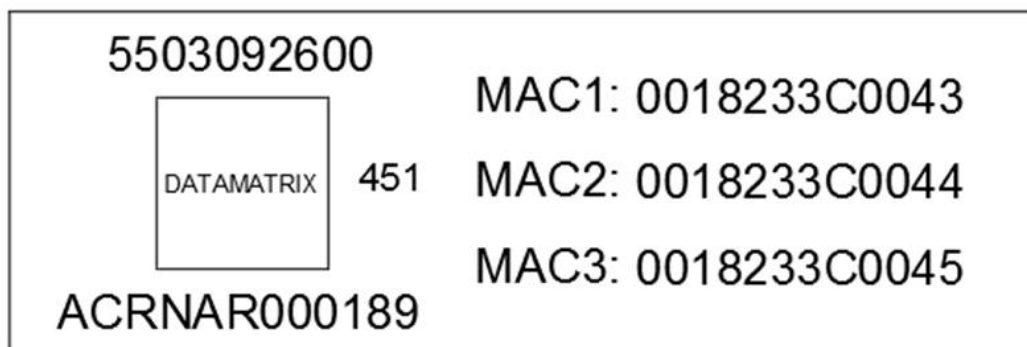

Definition	Description
MAC1	Port 1 MAC Address
MAC2	Port 2 MAC Address
MAC3	Interface MAC Address

## 3 Installation and Wiring

This section introduces how CMC-PN01 connects to VFD-C2000 and to network.

### 3.1 Installation

How to connect CMC-PN01 to VFD-C2000:

- Shut off the power supply to the AC motor drive.
- Open the front cover of the AC motor drive.
- Place the insulation spacer into the positioning pin at Slot 1 (see Figure 1), and line-up the two holes on the PCB at the positioning pin. Press the pin to clip the holes on the PCB (see Figure 2).
- Ensure the PCB is securely placed, and then fix the screws with 6–8 kg-cm of torque (5.21–6.94 lb-in.) as shown in Figure 3.

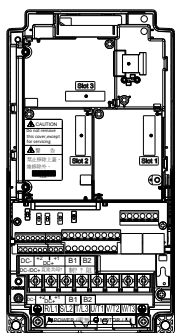

Figure 1

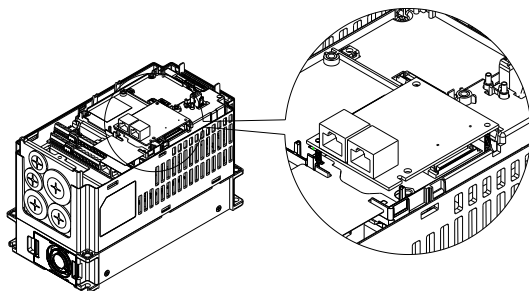

Figure 2

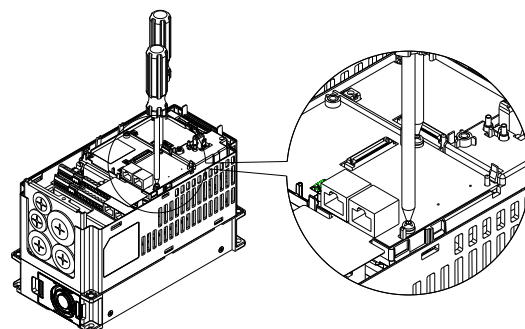

Figure 3

### 3.2 Unloading

How to detach CMC-PN01 from VFD-C2000:

- Shut off the power supply to the AC motor drive.
- Open the front cover of the AC motor drive.
- Remove the two screws (see Figure 4).
- Pull to open the card clip and put a flat-head screwdriver into the groove to pry the PCB off the card clip (see Figure 5).
- Release the other card clip to remove the PCB (see Figure 6).

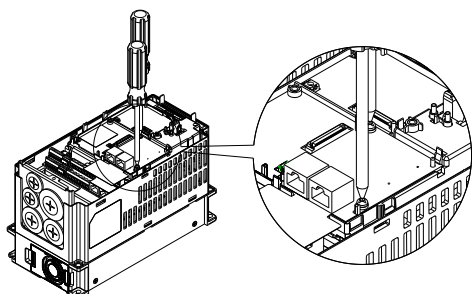

Figure 4

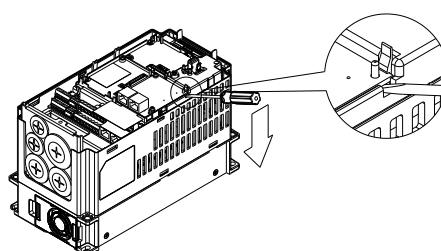

Figure 5

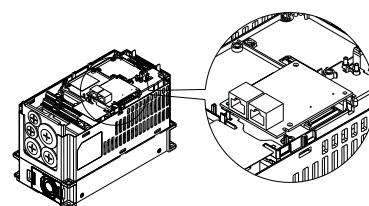
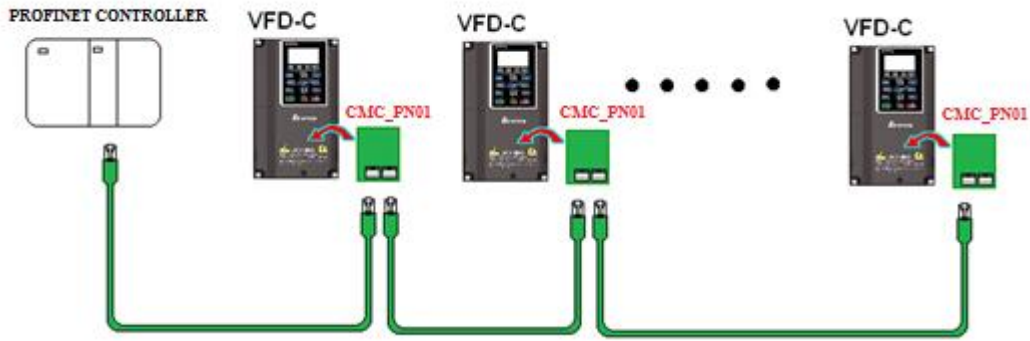

Figure 6

### 3.3 Connecting to the Network

The wiring of CMC-PN01 shows as follows:



When the installation is finished, supply electricity to the drive. The Pr.09-60 of the drive should be able to display “PROFINET” with a current value of 12. If not, make sure your version of the drive is correct (C2000 needs 2.04 or later versions) and the communication card is correctly connected.

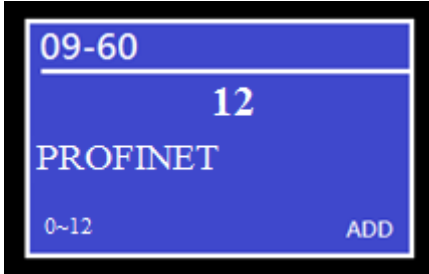

## 4 VFD-C2000 Drive Settings

When you operate VFD-C2000 through CMC-PN01, you should set the communication card as the source of VFD-C2000 controls and settings. You need to use the keypad to configure the following parameter addresses to the corresponding values:

Keypad Parameter No.	Settings/ Displayed Value	Description of Function
Pr.00-20	8	Set communication card as the source of frequency command.
Pr.00-21	5	Set communication card as the source of control.
Pr.09-30	1	Decoding method is either 60xx or 20xx.
Pr.09-60	12	Communication card identification: When CMC-PN01 communication card is connected, the value of this parameter displays "12".

Note: To make PLC or the host controller identify CMC-PN01, it is necessary to load the product description file (GSDML). You can download it directly from Delta's official website.

## 5 PROFINET Communication Profile

1. Synchronous parameter access in Delta-specific mode
2. Asynchronous parameter access
3. Identification & Maintenance functions (I&M)
4. Disconnection Treatment

### 5.1 Synchronous Parameter Access in Delta-specific Mode (Tables for Control Word and Status Word)

Table 1: 60xx Output Message (Host Controller→Drive) (Pr.09-30=1)

Bytes	Order	Address	Attribute	bit	Value	bit	User Rights	Speed Mode	Position Mode	Home Mode	Torque Mode	Notes		
0	LSB	6000h	RW	0	0	CMD_ACT	4	fcmd=0	None	Stop Home	Tcmd=0			
					Pulse 0									
					1					Tcmd=Test	Requires SERVO_ON=1			
					Pulse 1			POScmd=POSset	Execute Home once		Requires SERVO_ON=1			
				1	0	EXT_CMD1	4	FWD run command	Change when drive stops					
					1			REV run command	Immediate change					
				2	0	EXT_CMD2	4		Absolute movement					
					1				Relative movement					
				3	0	HALT	3	drive runs till target speed reaches	drive runs till target position reaches	Continue to return to home	Feed (Continue to run to target torque)			
					1			drive stops by declaration setting	Lock (drive stops at current position by declaration setting)	drive stops at current position by declaration setting	Lock (torque stops at current speed)			
				4	0	LOCK	4	drive runs till target speed reaches						
					1			frequency stops at current frequency						
				5	0	JOG	4	JOG OFF	JOG OFF	JOG OFF	JOG OFF			
					1									
					Pulse 1			JOG RUN	JOG RUN	JOG RUN	JOG RUN			
				6	0	QSTOP	2	None	None	None	None			
					1			Quick Stop	Quick Stop	Quick Stop	Quick Stop			
				7	0	SERVO_ON	1	Servo OFF	Servo OFF	Servo OFF	Servo OFF			
					1			Servo ON	Servo ON	Servo ON	Servo ON			
				11-8				0000	GEAR	4	Main speed	Main position		Main torque
0001-1111	1 <sup>st</sup> -15 <sup>th</sup> speed and frequency selection	1 <sup>st</sup> -15 <sup>th</sup> position selection												
13-12	00	ACC/DEC	4					1st Acceleration time			1st Acceleration time			
	01							2nd Acceleration time			2nd Acceleration time			
	10							3rd Acceleration time			3rd Acceleration time			
	11			4th Acceleration time	4th Acceleration time									
14	0	EN_SW	4	Multi-step command and	Multi-step command and		Multi-step command and							



								acceleration/ deceleration time switching are not allowed	acceleration/ deceleration time switching are not allowed		acceleration/ deceleration time switching are not allowed	
					1			Multi-step command and acceleration/ deceleration time switching are allowed	Multi-step command and acceleration/ deceleration time switching are allowed		Multi-step command and acceleration/ deceleration time switching are allowed	
				15	Pulse 1	RST	4	Clear error code	Clear error code	Clear error code	Clear error code	
2	LSB	6001h	RW				Mode Cmd					
3	MSB											
4	LSB	6002h	RW			Velocity Cmd	Velocity Cmd	Speed command (without numbers)	Profile velocity (without numbers)		Profile velocity (without numbers)	
5	MSB											
6	LSB	6003h	RW									
7	MSB											
8	LSB	6004h	RW			Pos Cmd	Pos Cmd		Position command (with numbers)			
9	MSB											
10	LSB	6005h	RW									
11	MSB											
12	LSB	6006h	RW			Torq Cmd	Torq Cmd				Torque command (with numbers)	
13	MSB											
14	LSB	6007h	RW					Reserved	Reserved	Reserved	Reserved	
15	MSB											
16	LSB	6008h	RW					Reserved	Reserved	Reserved	Reserved	
17	MSB											
18	LSB	6009h	RW					Reserved	Reserved	Reserved	Reserved	
19	MSB											

Table 2: 61xx Input Message (Drive→Host Controller) (Pr.09-30=1)

Bytes	Order	Address	Attribute	bit	Value	bit	Speed Mode	Position Mode	Home Mode	Torque Mode	Notes				
0	LSB	6100h	R	0	0	ARRIVE	Frequency command not reached	Position command not reached	Zero command unfinished	Torque command not reached					
					1		Frequency command arrival	Position command reached	Zero command completed	Torque command reached					
				1	0	DIR	FWD	FWD	FWD	FWD					
					1		REV	REV	REV	REV					
				2	0	WARN	No warning	No warning	No warning	No warning					
					1		Warning occurred	Warning occurred	Warning occurred	Warning occurred					
				3	0	ERROR	No error	No error	No error	No error					
					1		Error occurred	Error occurred	Error occurred	Error occurred					
				5	0	JOG	None	None	None	None					
					1		On JOG	On JOG	On JOG	On JOG					
				6	0	QSTOP	None	None	None	None					
					1		On Quick Stop	On Quick Stop	On Quick Stop	On Quick Stop					
				7	0	SERVO_ON	PWM OFF	PWM OFF	PWM OFF	PWM OFF					
					1		PWM ON	PWM ON	PWM ON	PWM ON					
				1	MSB			8	0	Ready	Ready OFF	Ready OFF	Ready OFF	Ready OFF	
									1		Ready ON	Ready ON	Ready ON	Ready ON	
				15-9											
2	LSB	6101h	R			Mode Cmd									
3	MSB														
4	LSB	6102h	R			Velocity cmd	Actual output	Actual output	Actual output	Actual output					
5	MSB														

6	LSB	6103h	R				frequency	frequency	frequency	frequency
7	MSB									
8	LSB	6104h	R			Pos Cmd	Actual position (absolute)	Actual position (absolute)	Actual position (absolute)	Actual position (absolute)
9	MSB									
10	LSB	6105h	R							
11	MSB									
12	LSB	6106h	R			Torq Cmd	Actual torque	Actual torque	Actual torque	Actual torque
13	MSB									
14	LSB	6107h	R				Reserved	Reserved	Reserved	Reserved
15	MSB									
16	LSB	6108h	R				Reserved	Reserved	Reserved	Reserved
17	MSB									
18	LSB	6109h	R				Reserved	Reserved	Reserved	Reserved
19	MSB									

Table 3: 20xx Output Message (Host Controller→Drive) (Pr.09-30=0)

Bytes	Order	Command	Address	Attribute	Value	Definition	Description			
0	LSB	Operation Command	2000h	W	b1-10	00: No function	Operation command unchanged	1. Bits in this column are used for operating actions. The commands are one-shot and run only when VFD receives commands. Therefore, Master only needs to issue the command once. VFD always runs the command issued by Master unless new commands are issued. 2. Bits in this column work only when VFD sets parameter selection operation command source as communication.		
						01: Stop	Stop operation command			
						10: Run	Normal command operation			
						11: JOG+Run	JOG command			
					b3-b2	Not used				
						b5-b4	00: No function		Direction command unchanged	1. Bits in this column are used for operating actions. The commands are one-shot and run only when VFD receives commands. Therefore, Master only needs to issue the command once. VFD always runs the command issued by Master unless new commands are issued. 2. Bits in this column work only when VFD sets parameter selection operation command source as communication.
					01: FWD		FWD direction command			
					10: REV		REV direction command			
					11: Change direction		Change current direction command			
					b7-b6	00: 1st Accel./Decel. time	1 <sup>st</sup> acceleration/deceleration time selection		Bits in this column are used for switching acceleration or deceleration time through communication when VFD operates. Parameter VFD can provide four kinds of settings for acceleration or deceleration time and use one-shot method to switch by bits in this column.	
						01: 2nd Accel./Decel. time	2 <sup>nd</sup> acceleration/deceleration time selection			
						10: 3rd Accel./Decel. time	3 <sup>rd</sup> acceleration/deceleration time selection			
11: 4th Accel./Decel. time	4 <sup>th</sup> acceleration/deceleration time selection									
1	MSB				b11-b8	0000: Main speed	Multi-step speed and frequency switching selection	1. Bits in this column are used for switching VFD's operation frequency through communication. Parameter VFD can provide 15 kinds of settings for operating speed and use one-shot method to switch by bits in this column. 2. You have to set 2000h b12=1 or you cannot use this multi-step speed and frequency switching function through communication. 3. If you want to know the current running speed of this multi-step speed and frequency switching function, check address 2017h.		
						0001: 1st step speed				
						0010: 2nd step speed				
						0011: 3rd step speed				
						0100: 4th step speed				
						0101: 5th step speed				
						0110: 6th step speed				
						0111: 7th step speed				
						1000: 8th step speed				
						1001: 9th step speed				
						1010: 10th step speed				
						1011: 11th step speed				
						1100: 12th step speed				
						1101: 13th step speed				
						1110: 14th step speed				
1111: 15th step speed										
b12	1: Enable b11-b6		Enable multi-step speed and frequency and acceleration or deceleration time switching function							
	b14-b13	00: No function	Switching for operation command source	Bits in this column are used for enforcedly switching operation command source through communication. If VFD operation source setting is not controlled by communication, you can use the bits in this column to enforcedly switch to communication or restore to parameter setting.						
01: Operation command controlled by PU										
10: Operation command by Pr. setting										
11: Switch between PU and Pr. setting										
b15										
	2	LSB						1. Bits in this column are used for issuing setting commands to VFD through communication. The default unit for this setting is Hz or otherwise (can be known from 211Dh bit12). If the units are Desc, address 2123h-2124h can be read. 2. Bits in this column work only when VFD frequency source parameter is set as the		
3	MSB	Speed Set Point Command	2001h		W	b15-b0	VFD Set Point Command		VFD multi-unit setup command	

4	LSB	VFD Fault/Control Command	2002h	W	b0	1:EF (external fault) ON	External Fault (EF) enabled	1. This bit is used for triggering an external fault to VFD to stop the running status. The method for stopping can be set by VFD parameter. 2. This bit operates by on-shot method and this fault can only be restored by Fault Reset command.
					b1	1: Reset	Fault Reset command	This bit is used for resetting the status from Fault to Ready.
					b2	1: b.b. ON	External B.B. (Base Block) enabled	This bit is used for triggering an external B.B. to VFD to pause the running status. When bit=0 (BB is dismissed), VFD immediately returns to its former status.
					b3	1: HAND-ON/LOC-ON command	HAND/LOCAL frequency operation source enabled	Whether switching HAND/AUTO or LOC/REM would lead to running STOP depends on motor drive's parameter settings.
					b4	1: AUTO-ON/REM-ON command	AUTO/REMOTE frequency operation source enabled	
5	MSB				b15-b5	Not used		
6	LSB		2003h	W	b15-b0	Reserved	Reserved	Reserved
7	MSB							
8	LSB		2004h	W	b15-b0	Reserved	Reserved	Reserved
9	MSB							
10	LSB		2005h	W	b15-b0	Reserved	Reserved	Reserved
11	MSB							
12	LSB		2006h	W	b15-b0	Reserved	Reserved	Reserved
13	MSB							
14	LSB		2007h	W	b15-b0	Reserved	Reserved	Reserved
15	MSB							
16	LSB		2008h	W	b15-b0	Reserved	Reserved	Reserved
17	MSB							
18	LSB		2009h	W	b15-b0	Reserved	Reserved	Reserved
19	MSB							

Table 4: 21xx Input Message (Drive→Host Controller) (Pr.09-30=0)

Bytes	Order	Command	Address	Attribute	Value		Definition	Description
0	LSB	Fault Status	2100h	R	b7-b0	Error Code	Fault codes	Bits in this column are used for checking if VFD occurs any fault, and using the fault codes to substitute 32XXh to obtain the description strings for the fault.
	b15-b8				Warn Code	Warning codes	Bits in this column are used for checking if VFD occurs any warnings, and using the warning codes to substitute 33XXh to obtain the description strings for the fault.	
2	LSB	Operation Status	2101h	R	b1-b10	00: RUN LED light off, STOP LED light up (Drive Stop)	Run and stop status	Bits in this column are used for checking VFD's running status in order to control its LED display.
						01: RUN LED blink, STOP LED light up (Drive Decelerate during the drive stopping)		
						10: RUN LED light up, STOP LED blink (Drive standby)		
						11: RUN LED light up, STOP LED light off (Drive Run)		
					b2	1: JOG active	JOG running status	
b4-b3	00: REV LED light off, FWD LED light up (Forward)	Operation direction status	Bits in this column are used for checking VFD's running direction status in order to control its LED display.					
	01: REV LED blink, FWD LED light up (Reverse to Forward)							
	10: REV LED light up, FWD LED blink (Forward to Reverse)							
	11: REV LED light up, FWD LED light off (Reverse)							
b5	1: Factory parameters opened	Factory parameter ON/OFF status (not used)						
b6	Reserved							
b7	1: Operation command controlled by external terminal		Bits in this column are used for checking whether VFD's current operation command source is external terminal or not. If bit=1, external terminal has the highest processing priority. Master communication can obtain control rights only when it switches operation command source by 2000h b14-13.					
3	MSB				b8	1: Main Freq. controlled by communication		Bits in this column are used for checking the current VFD frequency command source.
					b9	1: Main Freq. controlled by external terminal (AI)		
					b10	1: Operation command controlled by Communication		Bits in this column are used for checking whether the current VFD operation command source are communication or not.
					b11	1: Parameters been locked	Parameter Lock ON/OFF status	Bits in this column are used for checking whether VFD's parameters are locked or not. If bit=1, the values for reading parameters are always 0.
					b12	0: AC drive stop, 1: AC drive run	VFD actual running output status (RUNNING=1)	
					b13	Jog command	JOG running	

						command status (CMDJOG=1)					
				b14							
				b15							
4	LSB	VFD Variable Monitor	2102h	R	b15-b0	Frequency Command	Bits in this column are used for displaying VFD's current running frequency command values (2dot value) with its unit Hz.				
5	MSB						2103h	R	b15-b0	Output Frequency	Bits in this column are used for displaying VFD's current output frequency values (two-dot value) with its unit Hz.
6	LSB						2104h	R	b15-b0	Output Current	Bits in this column are used for displaying VFD's current output current values (one-dot value) with its unit A.
7	MSB						2105h	R	b15-b0	DC BUS Voltage	Bits in this column are used for displaying VFD's current DC BUS voltage values (one-dot value) with its unit V.
8	LSB						2106h	R	b15-b0	Output Voltage	Bits in this column are used for displaying VFD's current output voltage values (one-dot value) with its unit V.
9	MSB						2107h	R	b15-b0	Multi-step speed	Bits in this column are used for displaying VFD's current multi-step speed and frequency values.
10	LSB						2108h	R	b15-b0		
11	MSB						2109h	R	b15-b0	Value of the counter	
12	LSB						210Ah	R	b15-b0	Power factor angle (0-180.0 degree)	
13	MSB						210Bh	R	b15-b0	Torque (xxxx.x N-M)	
14	LSB						210Ch	R	b15-b0	Motor speed (rpm)	
15	MSB						210Dh	R	b15-b0	PG feedback pulse count	
16	LSB						210Eh	R	b15-b0	PG reference pulse count	
17	MSB						210Fh	R	b15-b0	Output Power (xx.xxxW)	
18	LSB										
19	MSB										
20	LSB										
21	MSB										
22	LSB										
23	MSB										
24	LSB										
25	MSB										
26	LSB										
27	MSB										
28	LSB										
29	MSB										
30	LSB										
31	MSB										

Table 5: Disconnection Treatment (CMC-PN01→Drive)

Address	Attribute	Value		Definition	Description
2505h	R	P9-63	Card Fault	This section is only allowed to be written by the card.	This address can correspond to VFD's communication parameter.

## 5.2 Asynchronous Parameter Access

Host controller PROFINET sends a write request first, then CMC-PN01 determines whether the host controller needs to read or write in accordance with the Operation field in the packet, and read or write drive's parameters through the contents of Data Block.

If there is no problem for the packet and CMC-PN01 is not in a busy mode, CMC-PN01 sends a write response to make the host controller be aware that CMC-PN1 has received the packet delivered and performed corresponding actions accordingly.

If the host controller requests to read the parameters, CMC-PN01 needs to send a read request after sending a write response. Then CMC-PN01 reads the corresponding parameters of the drive and replies to the host controller in the packet of read response.

The table below shows the definitions of the packet:

Field(s)	Description	Range	Type
Service	Request or Response service.	Request (0x00) Response (0x80)	UI8
Operation	Read or Write operation.	Write (0x08) Read (0x09)	UI8
Block Length	Length of the block.	0...0xFFFF	UI16
ARUUID	Identifier - time low - time mid - time high and version – clock – node	-	UI32 UI16 UI16 Qctet[2] Qctet[6]
API	Application Process Identifier	Device Access Point (0x000) PROFIdrive (0x3A00)	UI32
Slot	Slot of the Module Access Point (MAP/PAP)	0x01	U16
Sub-slot	Sub-slot of the Module Access Point (MAP/PAP)	0x01	U16
Padding	2 bytes		
Index	Index of the Record Data Object	0x0001-0x7FFF 0xB02E	U16
Data length	Length of the data block	0...0xFFFFFFFF	UI32

Additional value 1 (response only)	Field for transferring additional data	-	UI16
Additional value 2 (response only)	Field for transferring additional data	-	UI16
Padding	24 bytes for request; 20 bytes for response.		
Data block	Used only with request and read response.		

The timing diagram of parameter access shows as follows:

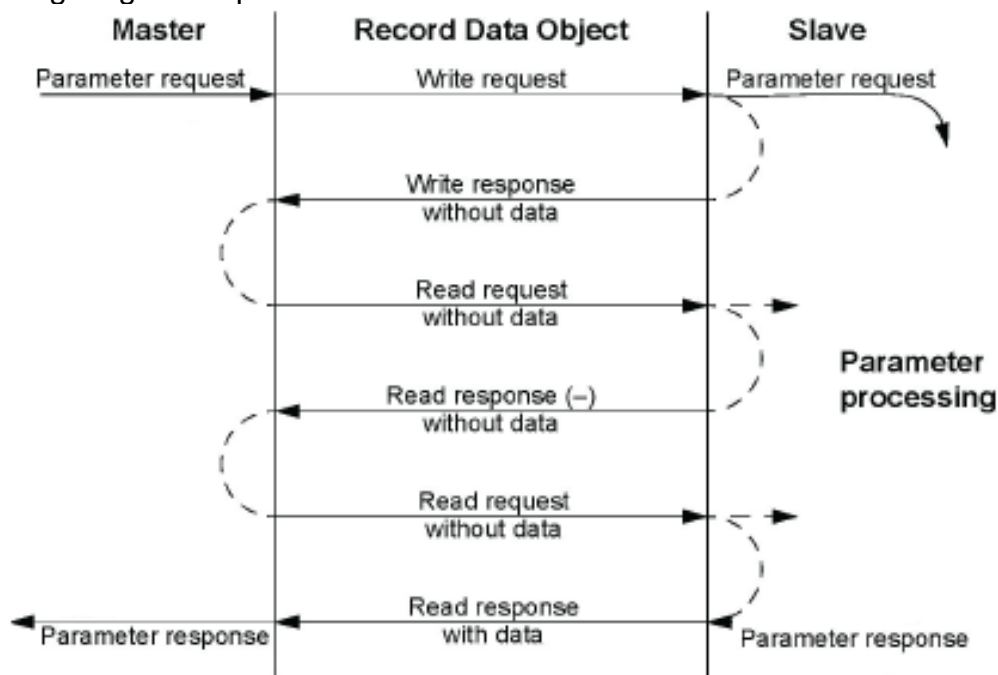

### 5.3 Identification and Maintenance Functions (I&M)

Identification and maintenance (I&M) is to provide you with supports in adjustment, test, parameterization and repair.

CMC-PN01 supports I&M0 functions and access by read requests that record data objects.

The table below shows the data structure of I&M0 functions:

Content	Size	Description
Header	10 bytes	-
Vendor ID	2 bytes	PROFINET Vendor ID of Delta, which is 0x03BF.
Order ID	20 bytes	Order number
Serial number	16 bytes	Serial number
Hardware revision	2 bytes	Hardware revision
Software revision	4 bytes	Revision of the software
Revision counter	2 bytes	Number of revision
Profile ID	2 bytes	0x00
Profile specific type	2 bytes	No profile specific type (0x0000)
I&M version	2 bytes	Version 1.1 (0x0101)
Supported I&M functions	2 bytes	I&M0 is supported (0x0001).

### 5.4 Disconnection Treatment

When PROFINET is disconnected, CMC-PN01 performs the following settings to ensure safety.

1. Set 2505H = 81 → Ecto indicates CMC-PN01 occurs a disconnection failure
2. Set 6000H = 0
3. Set 2000H = 1

When PROFINET connection restores, it resumes performing commands from the host controller.

## 6 Connection Configuration to Host Controller

This section introduces how Siemens STEP 7 and TIA PORTAL PLC integral software, as well as Siemens PLC S7-300 and S7-1500 use PROFINET to connect C2000 drive. The connection configuration shows as the figure below. Siemens PLC connects CMC-PN01 communication card of C2000 drive through the EtherNet.



### 6.1 Basic Configuration

- The Settings for Communication

1. Start your PC and set IP address configuration as static IP address. It is recommended to set the address to 192.168.xxx.xxx in the red box as the figure below shows.

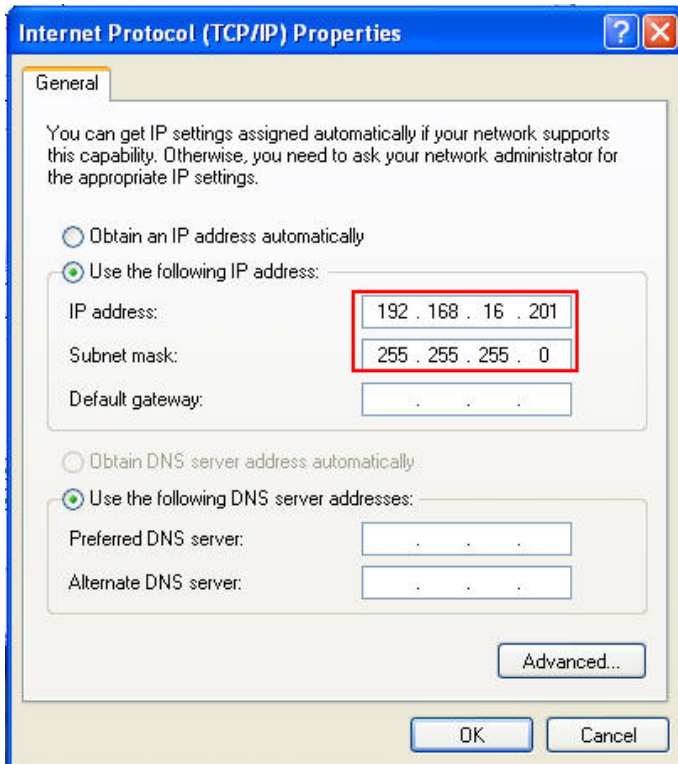

2. Use Siemens STEP 7 to look up the host controller's IP address. In the screen of HW Config, perform the function under **PLC→EtherNet→Edit EtherNet Node** as the figure below shows.

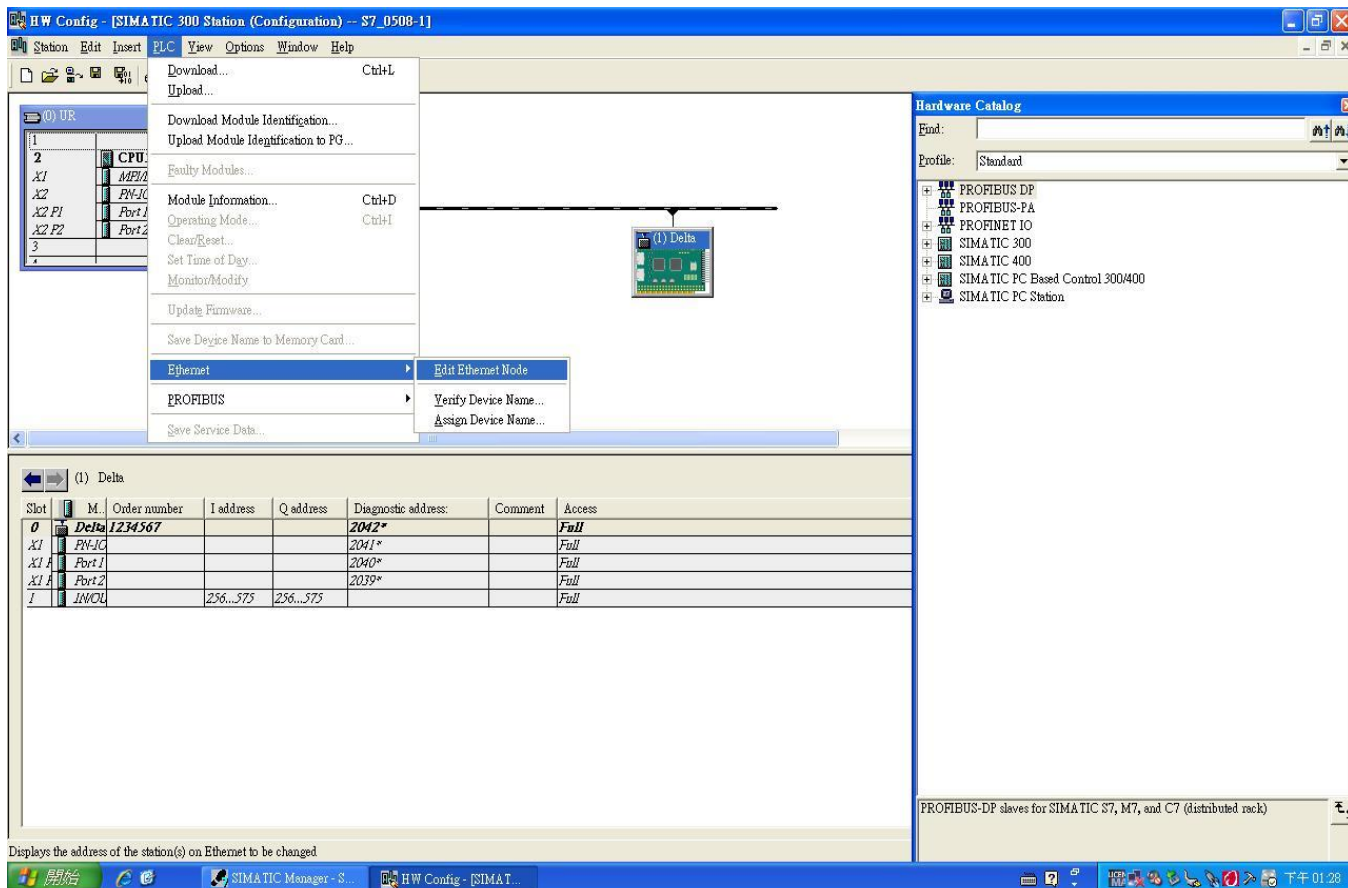

Click **Browse** button to search the available device on the Internet.

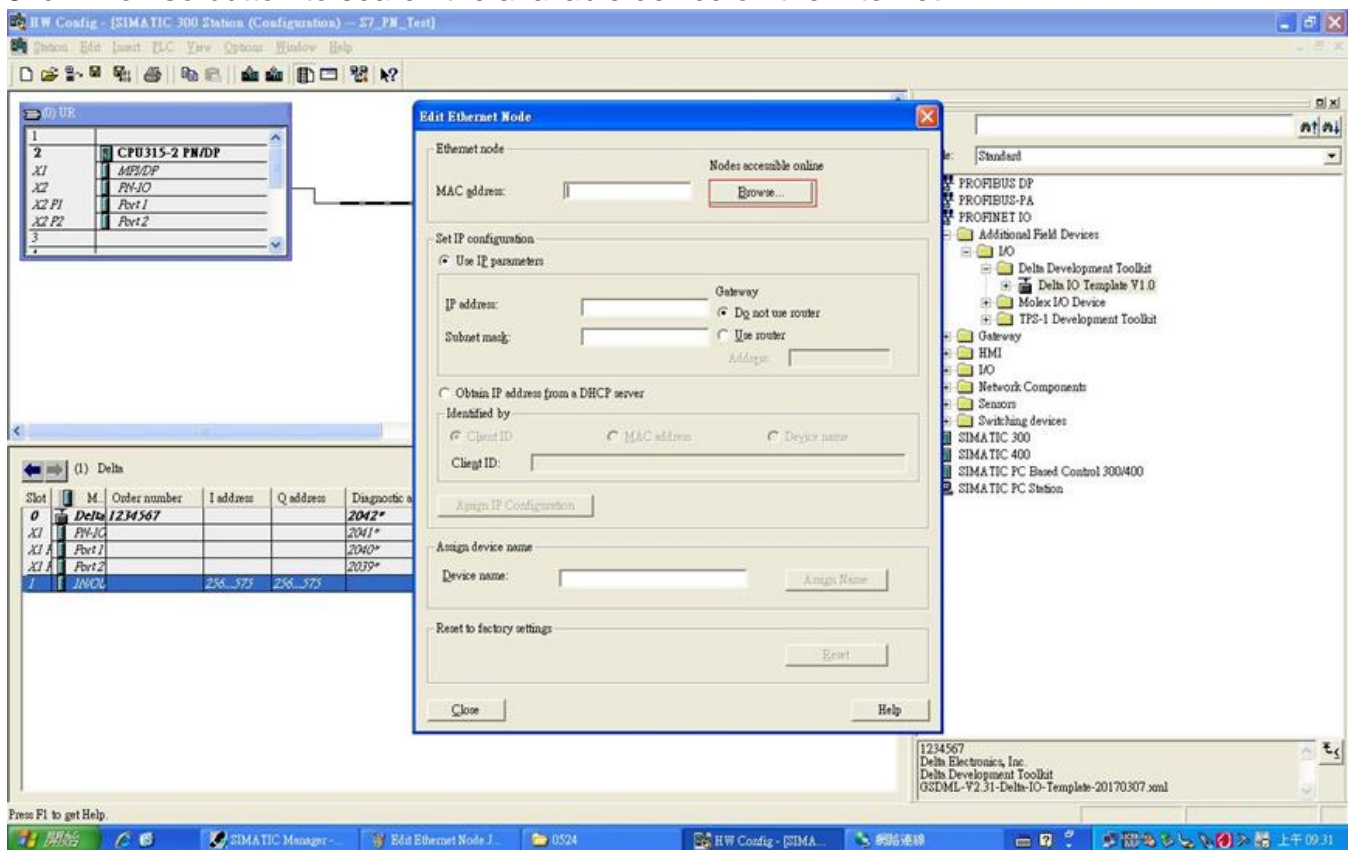



When it finishes searching, a screen displays as shown in the figure below. The IP address displays 192.168.16.26.

If the IP address of your computer is set as a different one, it is recommended to reset your PC's IP address to make it consistent with PLC's domain.

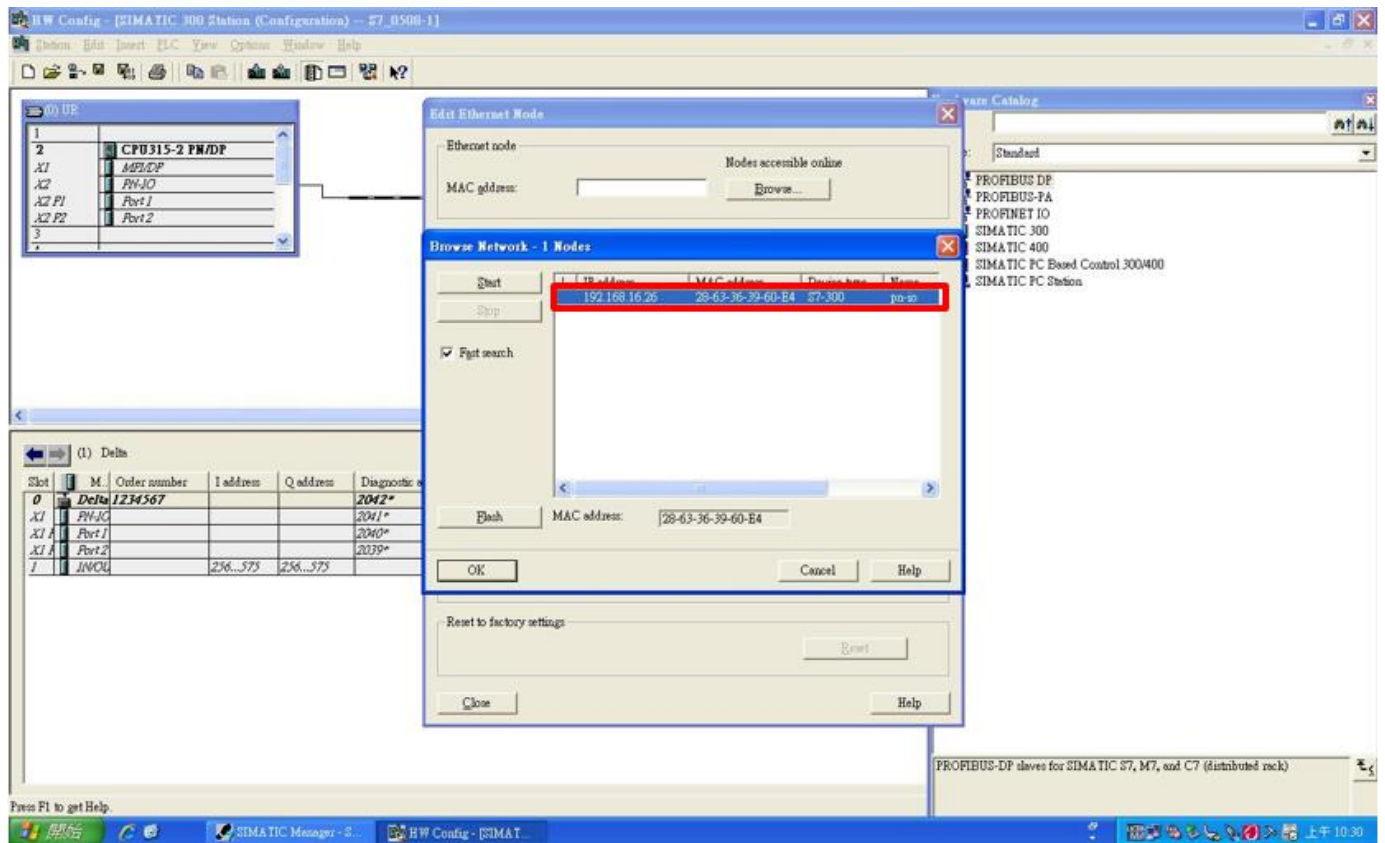

※ Note: If the IP address of your computer is different from PLC's domain, you are unable to download the program to PLC.

- Using Siemens TIA PORTAL to search PLC IP address. Start TIA PORTAL, select **Online&Diagnostics**, and then click **Project view**.

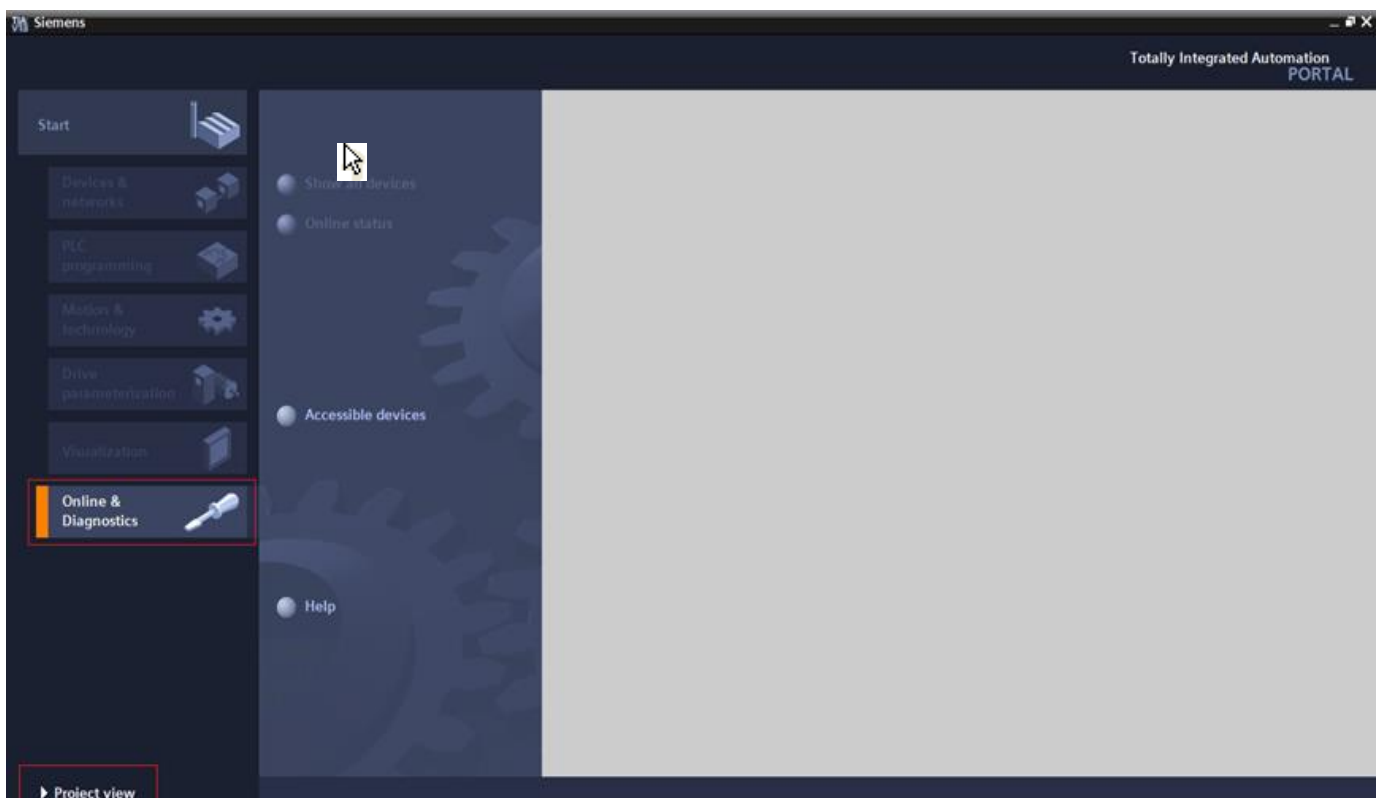



Select **Online access**, choose your PC network interface card, and then click **Update accessible devices** continuously to search PLC.

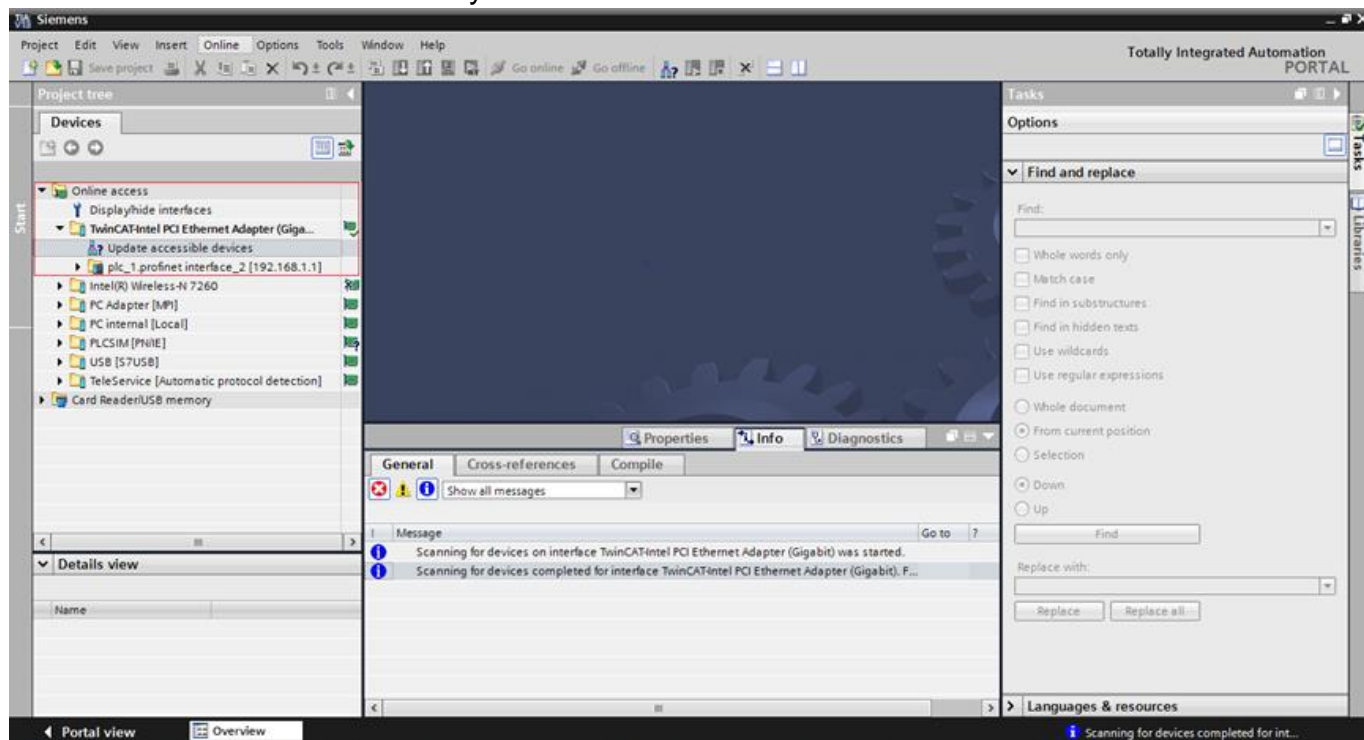

✘ When you start TIA PORTAL, do not enable wireless network because it may lead to TIA PORTAL's false detection. If it happens (physical interface card cannot be found), close the wireless network connection first and then restart TIA PORTAL.

4. Modify the name of CMC-PN01. The steps are the same as those for setting PLC address. For STEP7, set the drive name as the figure below shows.

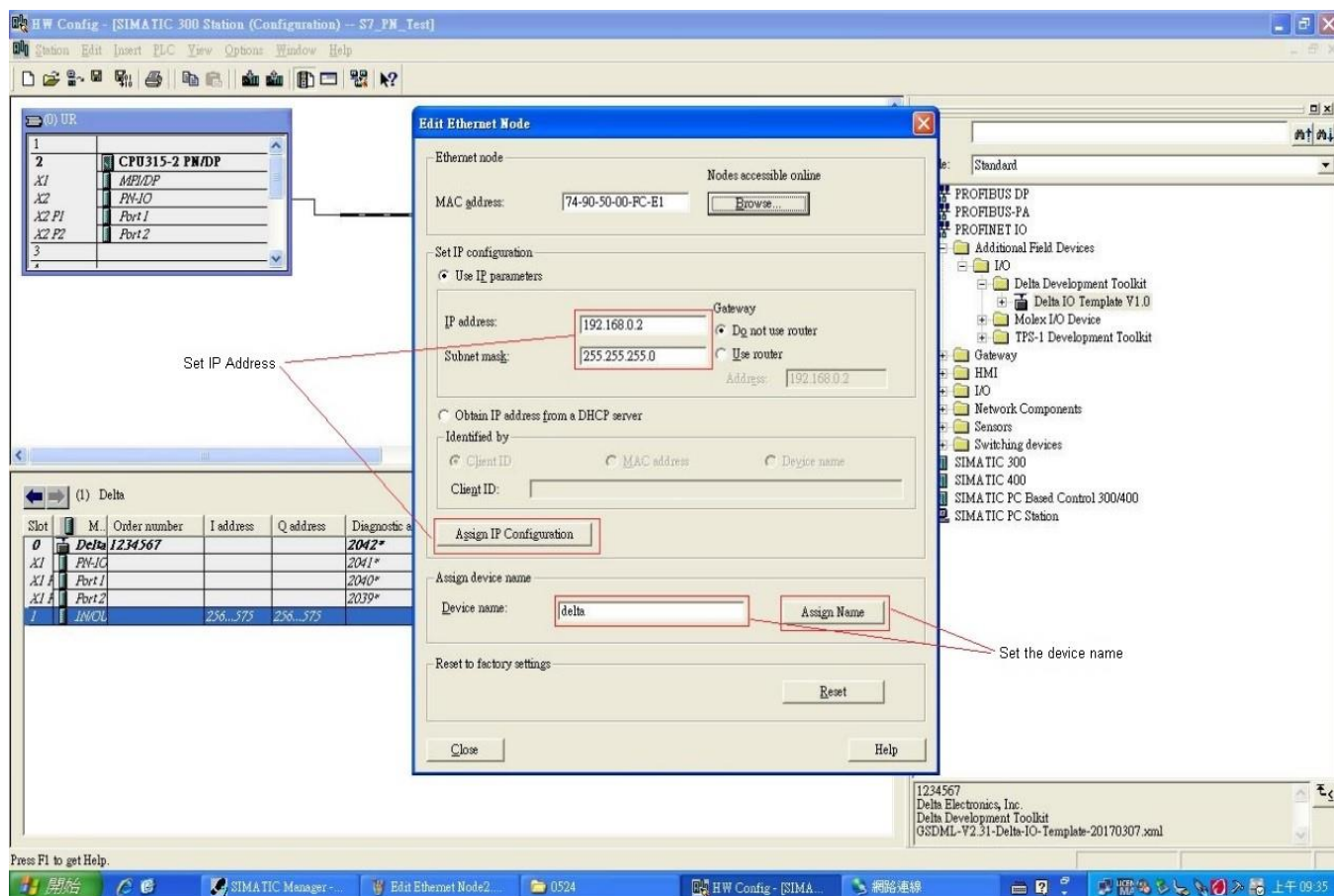

For TIA PORTAL, set the device name of the host controller or CMC-PN01 as the figure below shows.

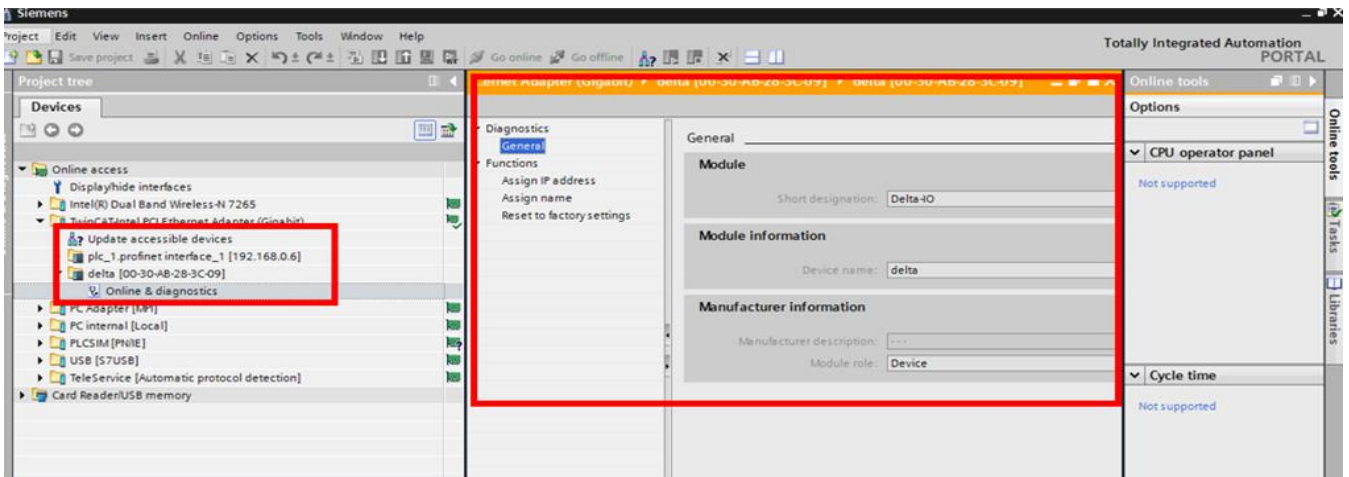
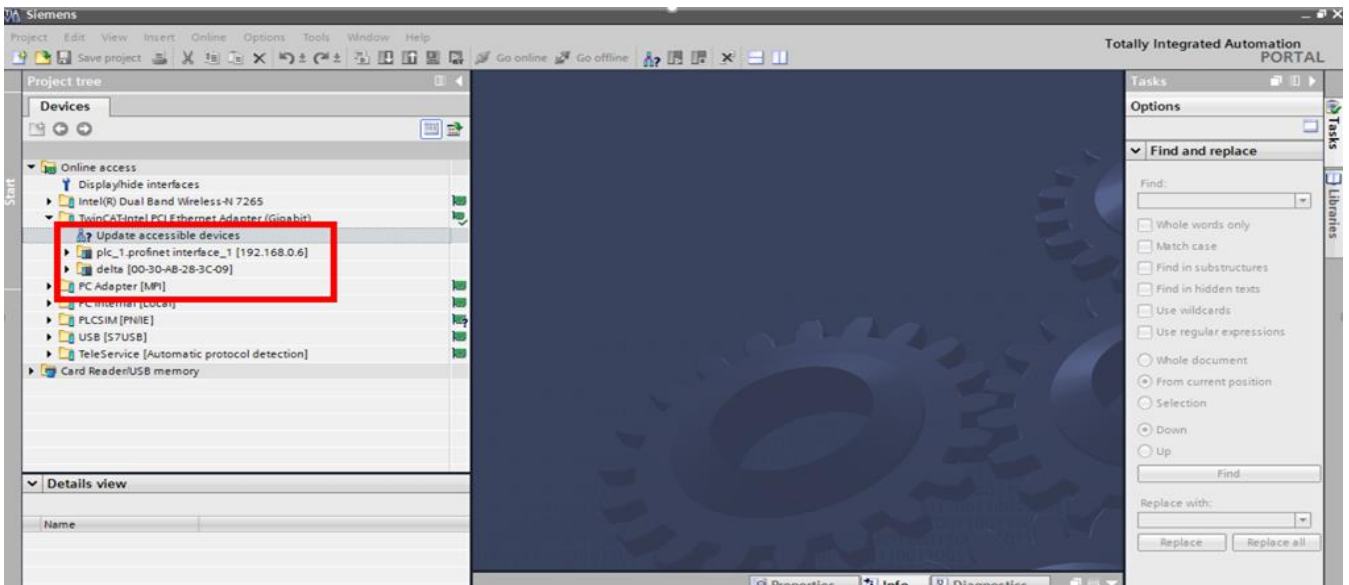
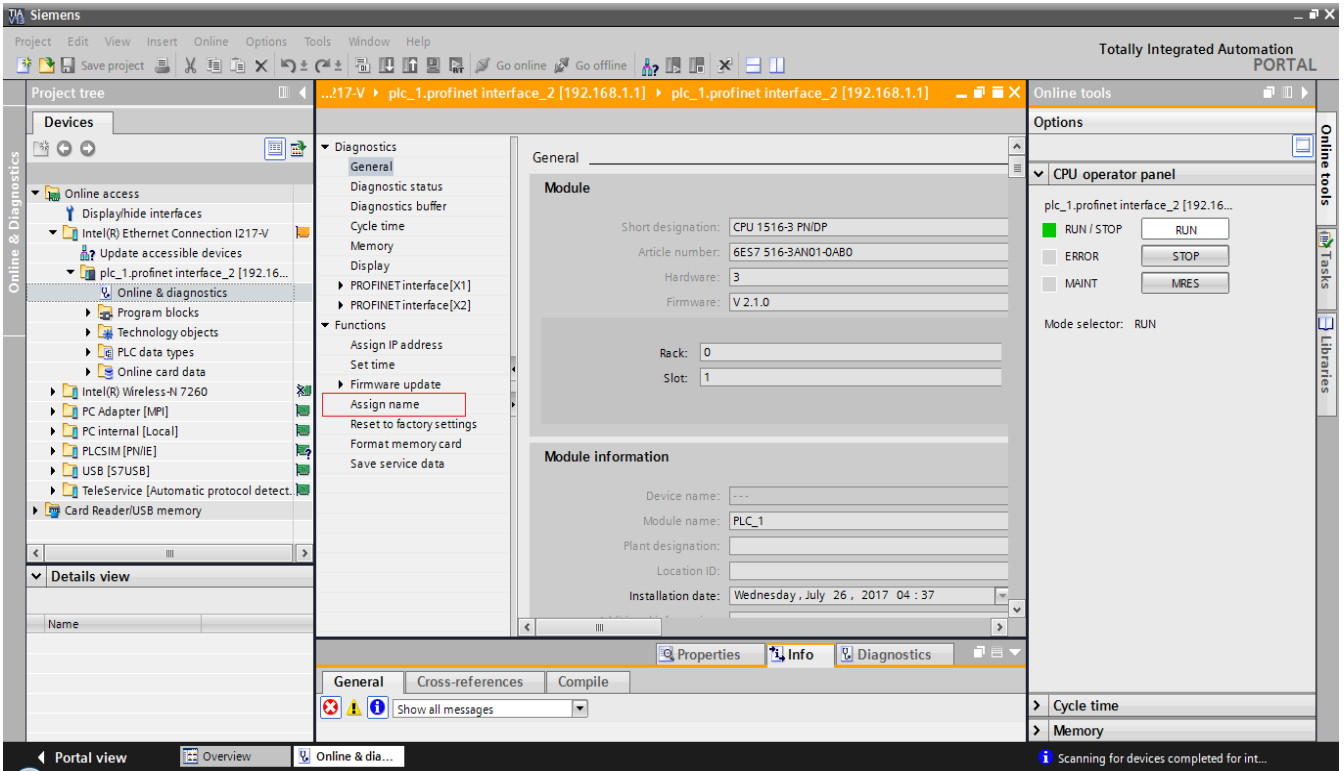

## 6.2 Speed Mode DEMO (S7-300 + STEP 7)

- Using Siemens STEP 7 to finish PLC setting, connection test, and speed mode DEMO

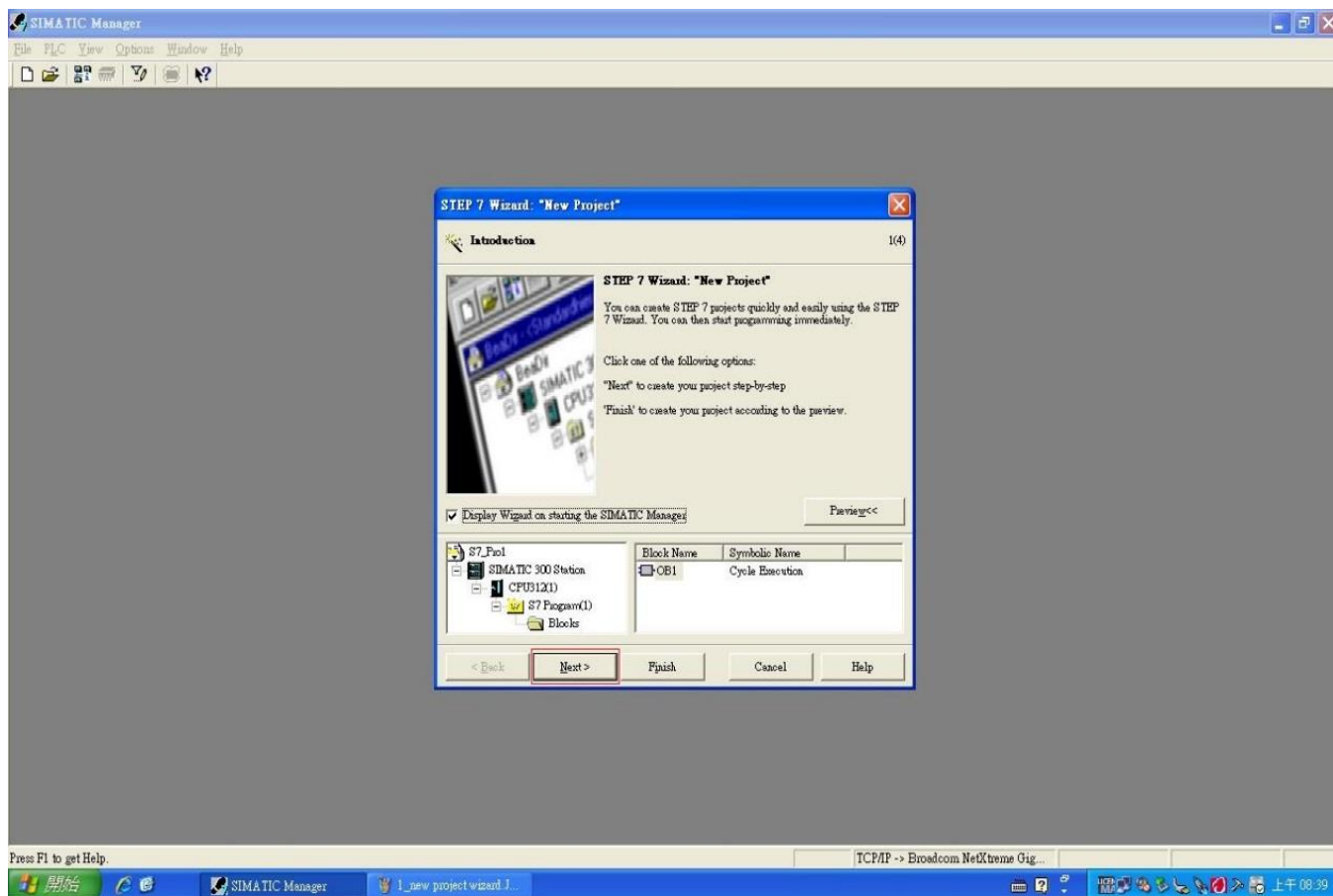
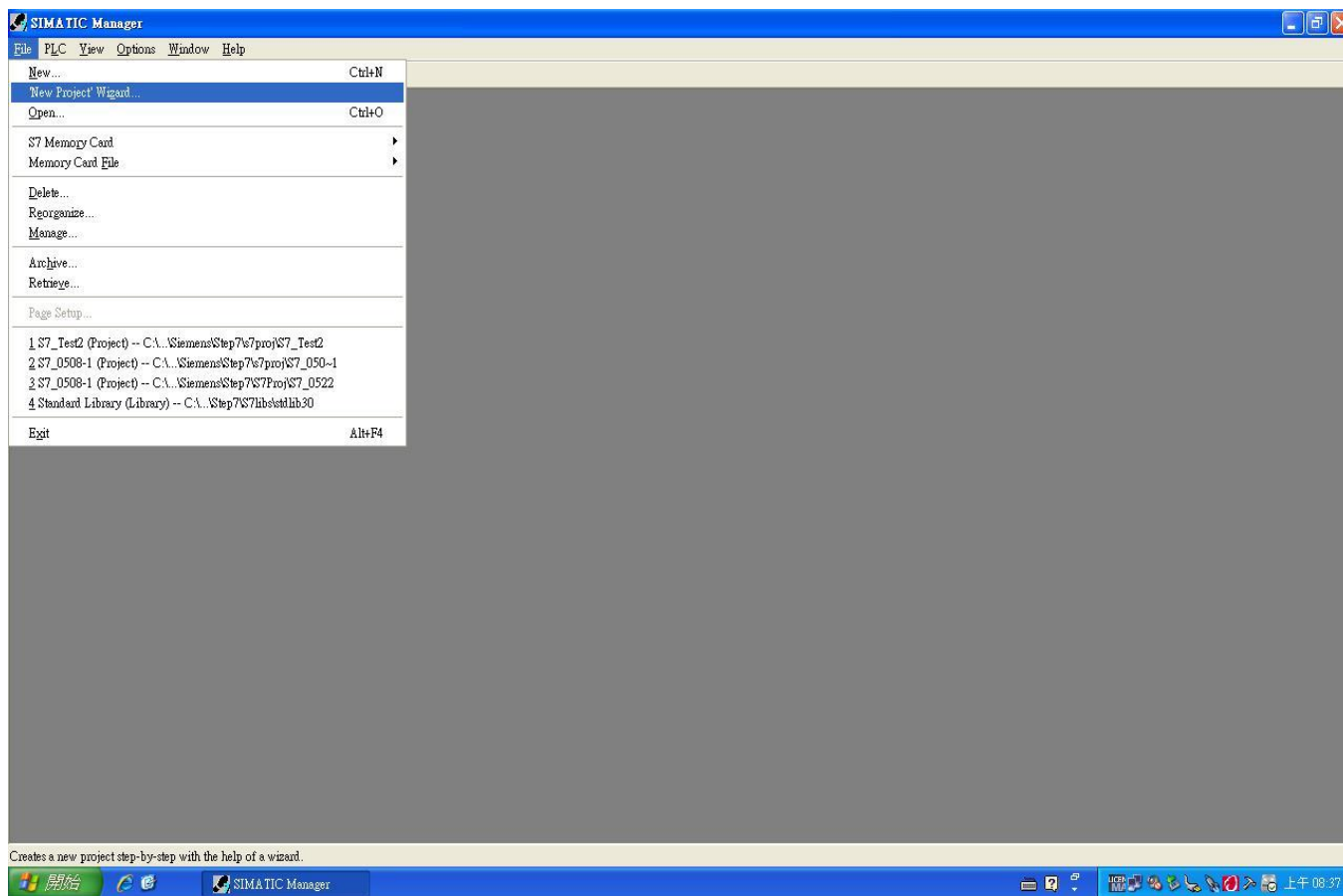

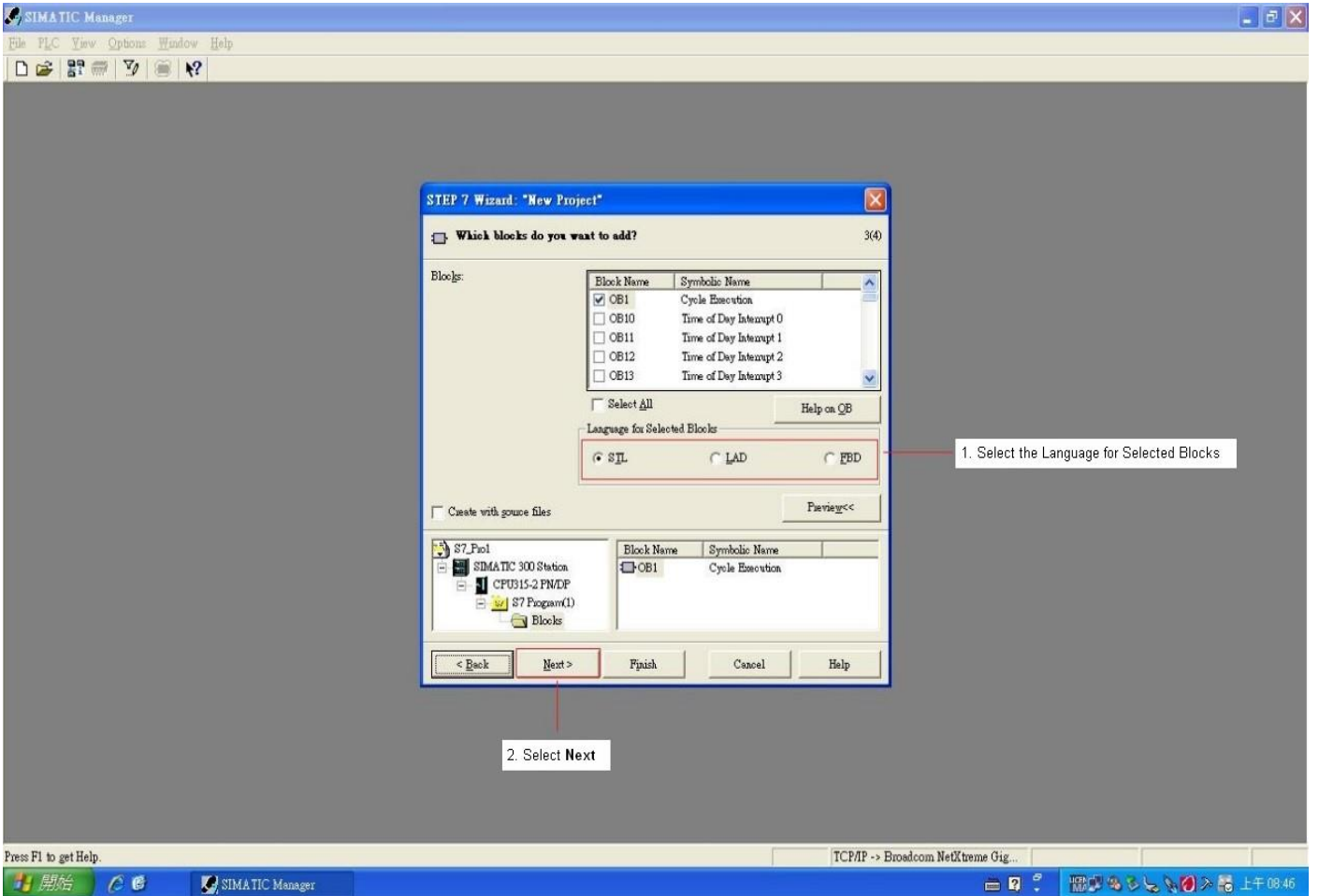
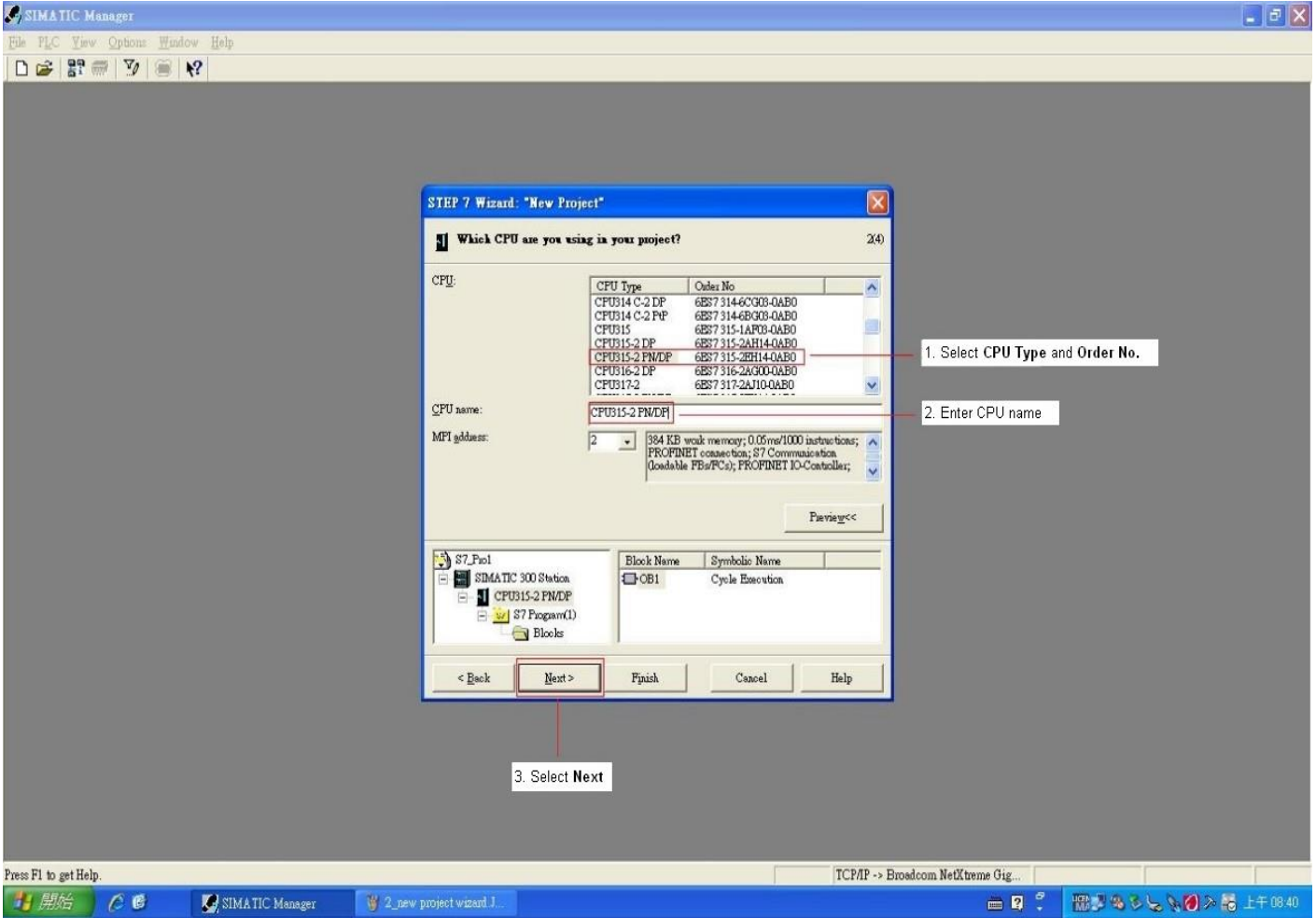



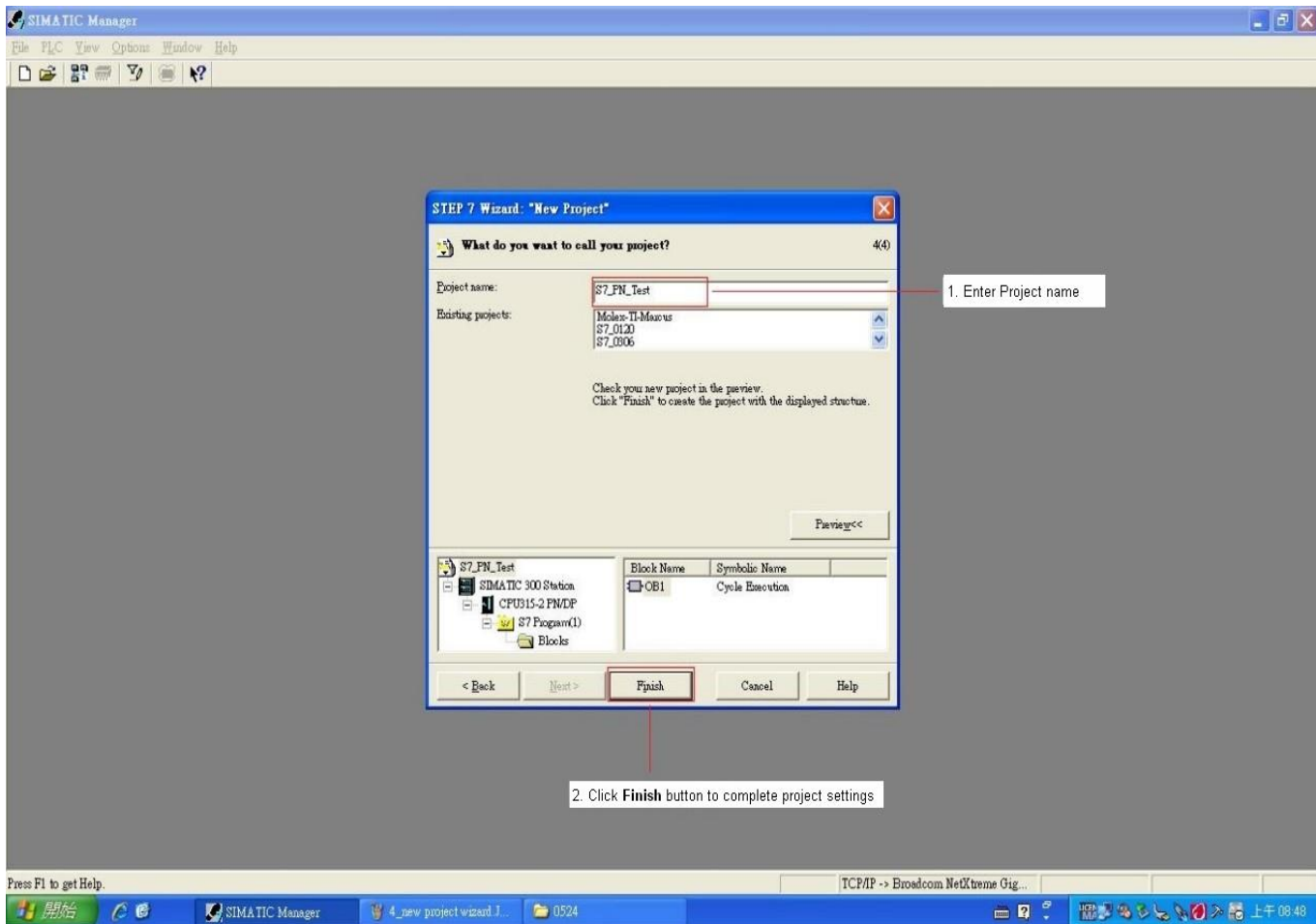

In HW Config, install GSDML and set up PROFINET framework as the figure below shows.

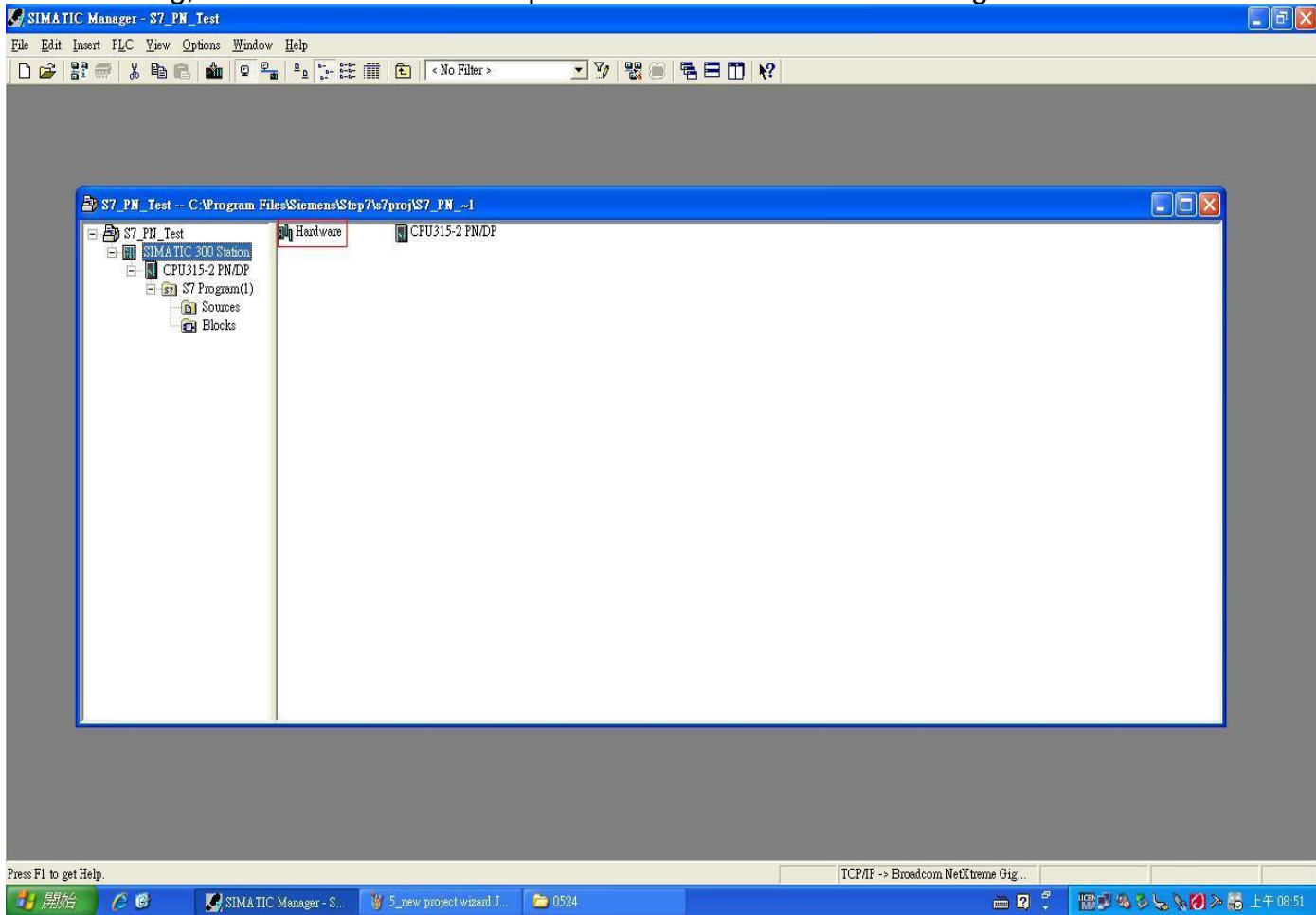

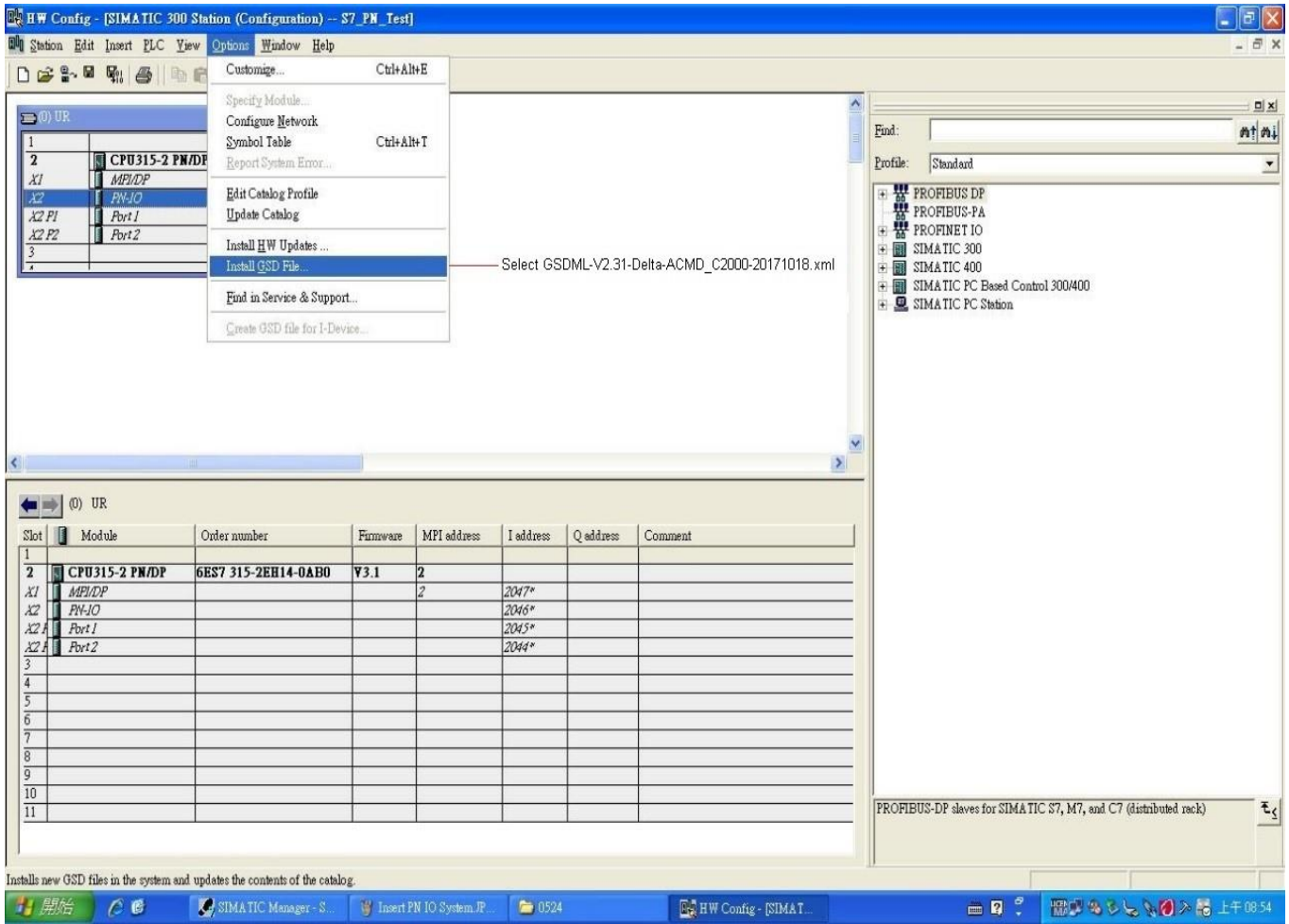

When the installation of GSDML is completed, the right side in the figure below displays.

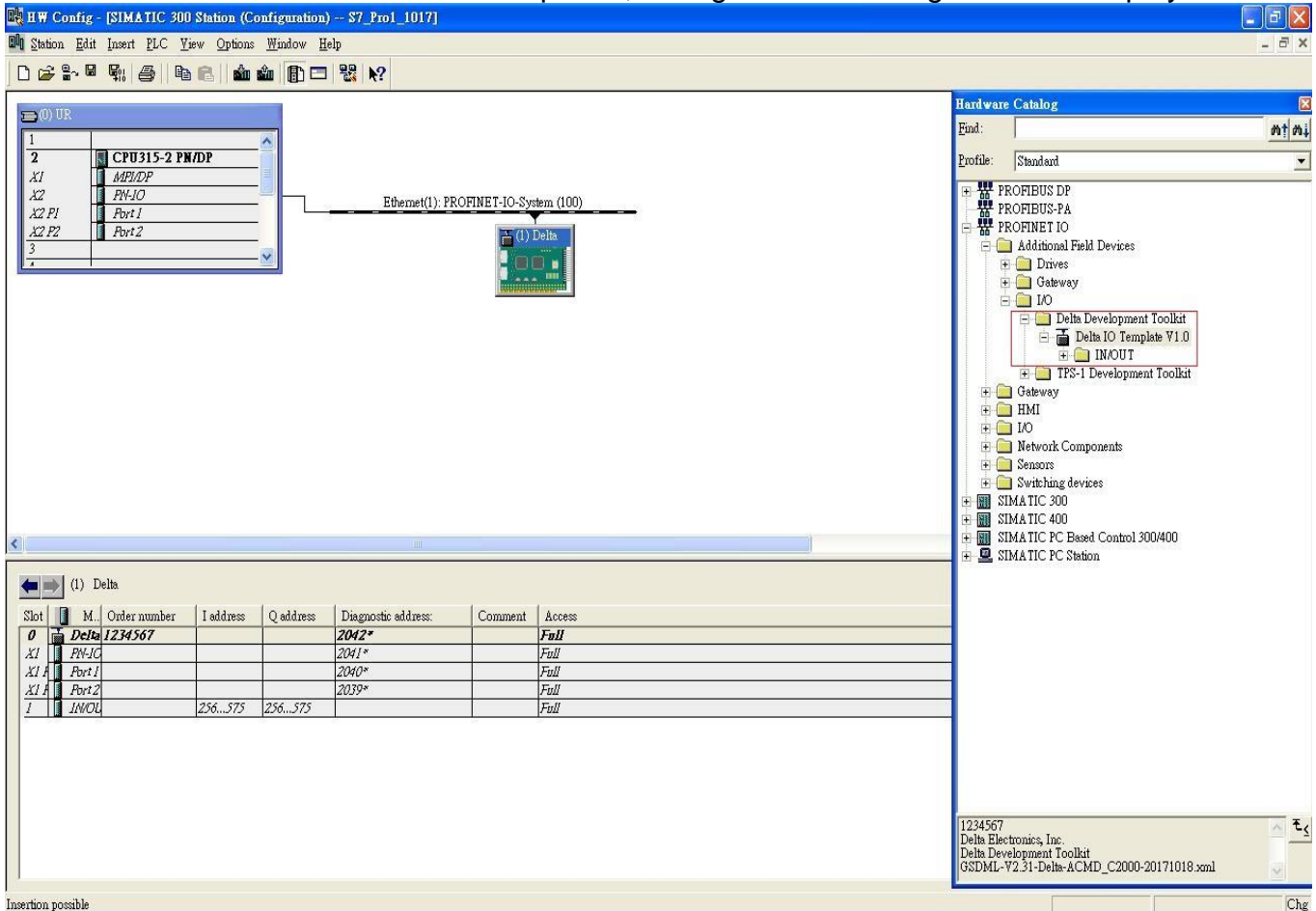

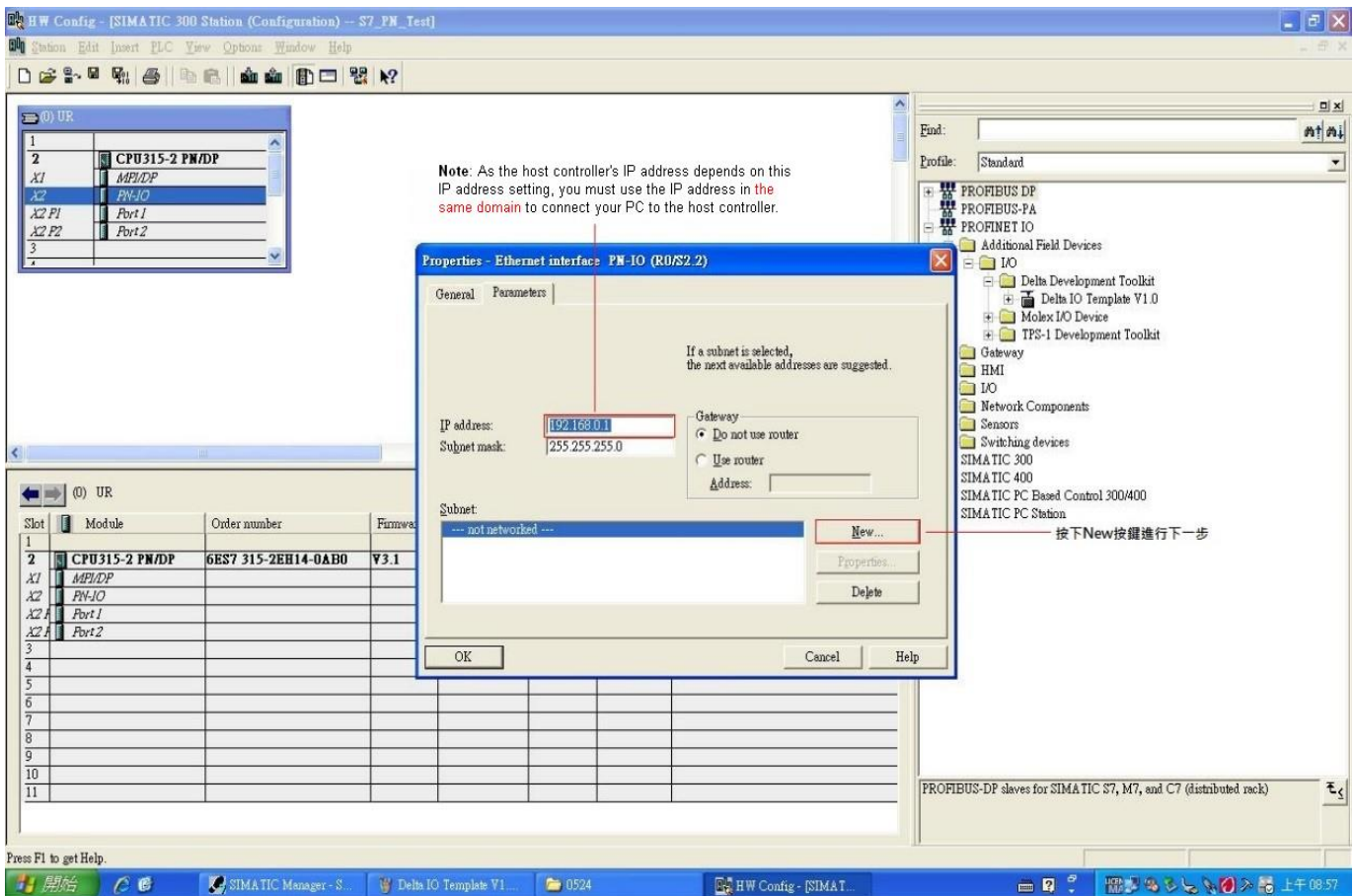
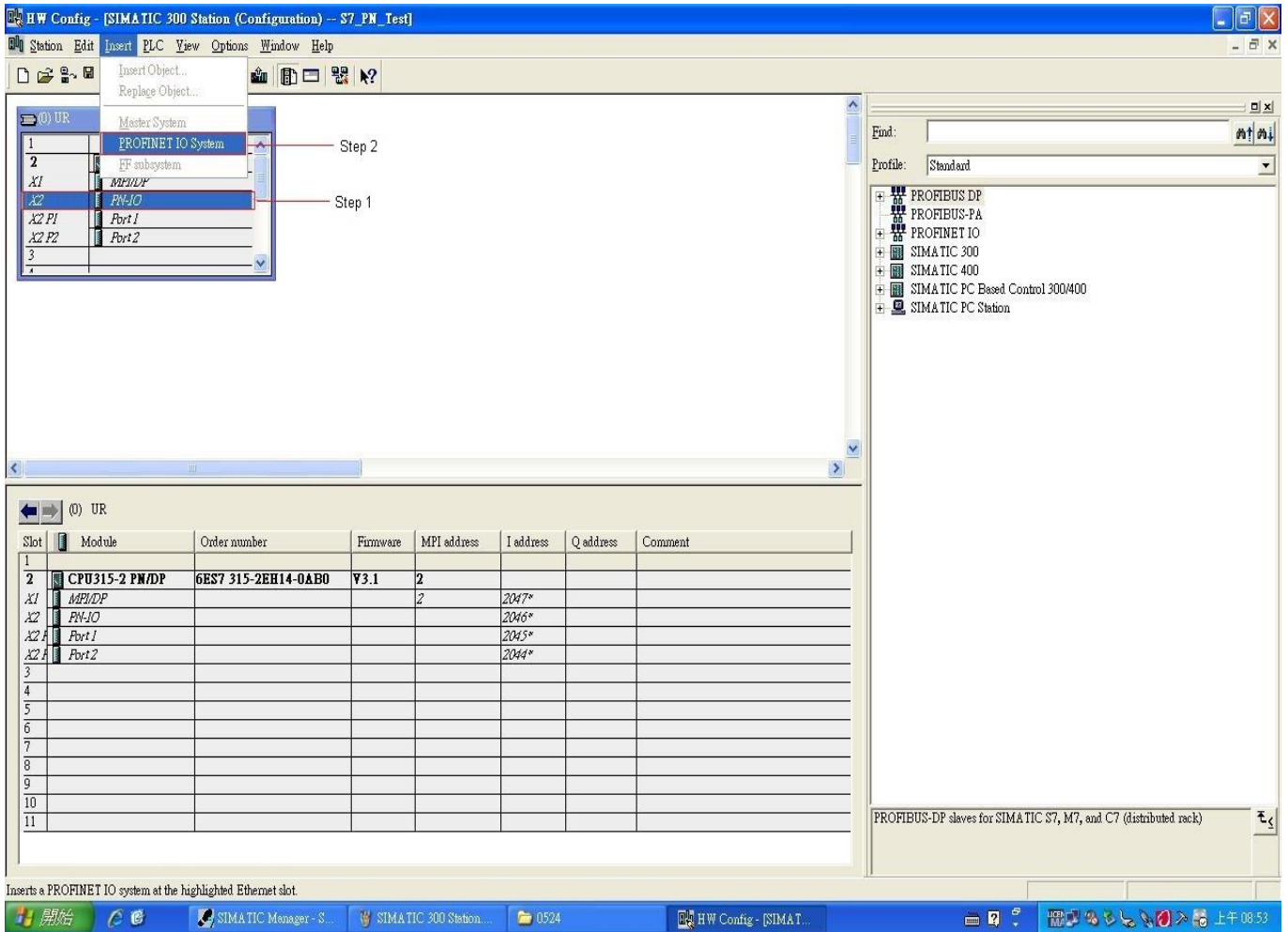

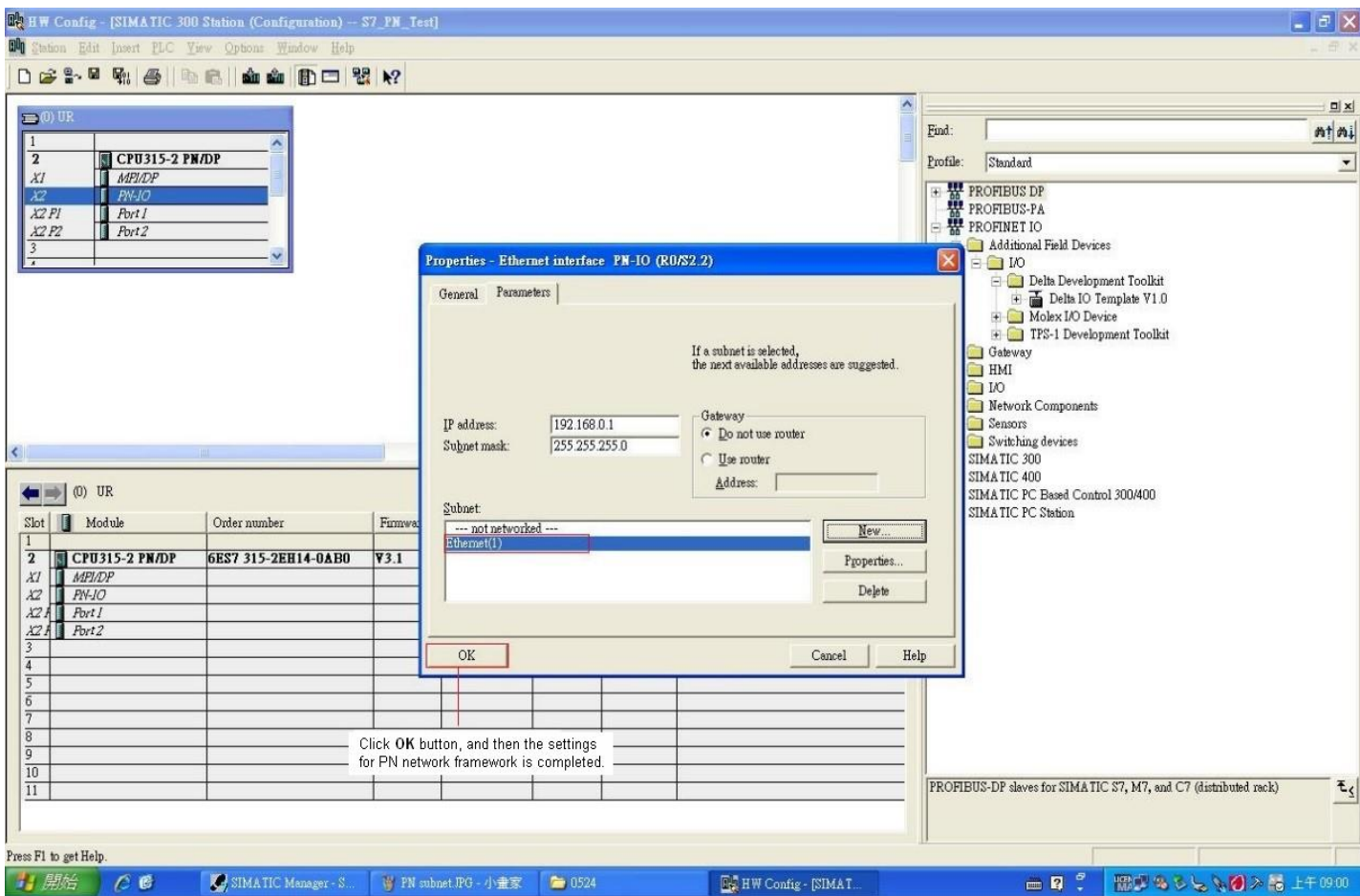
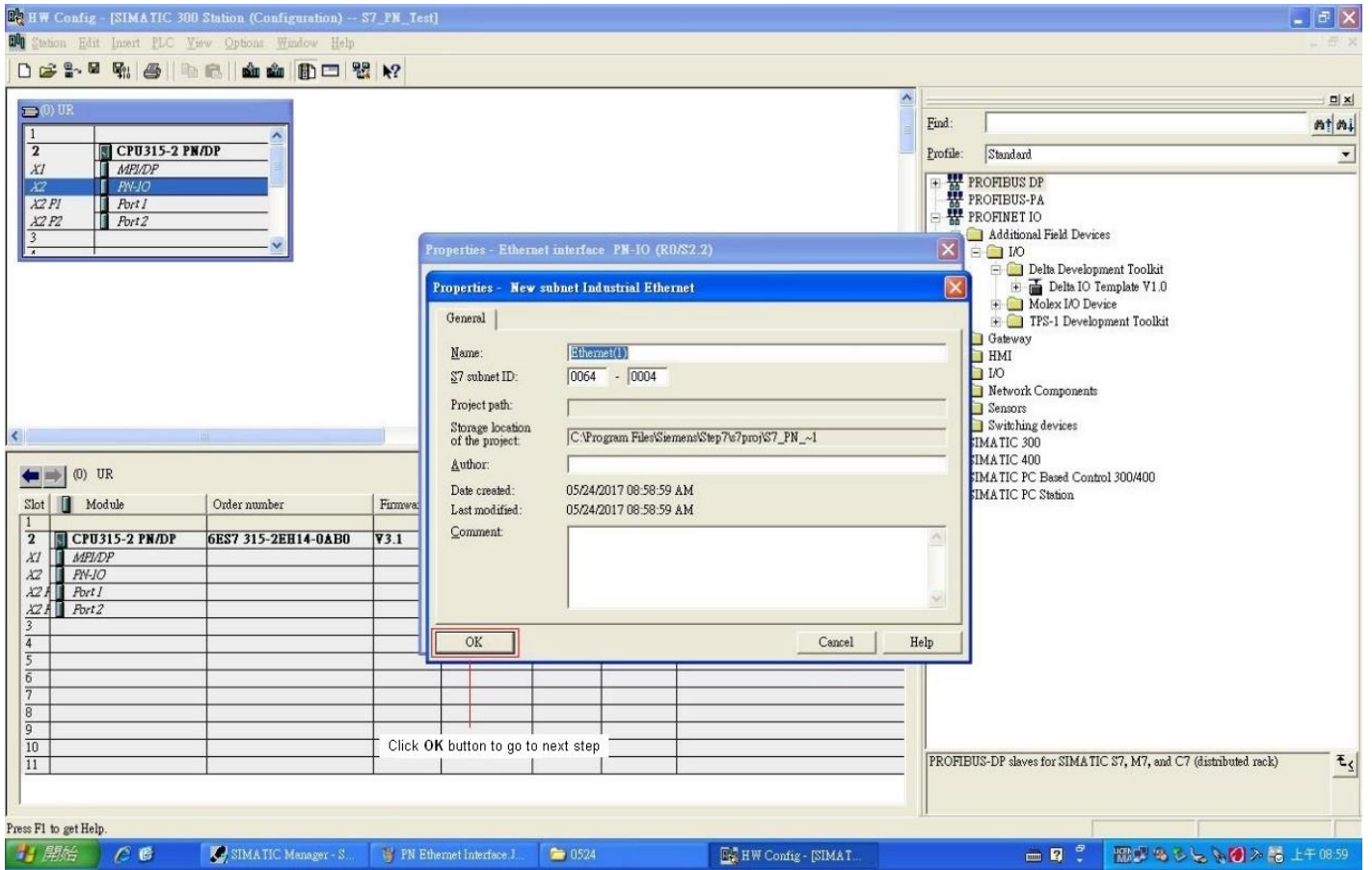



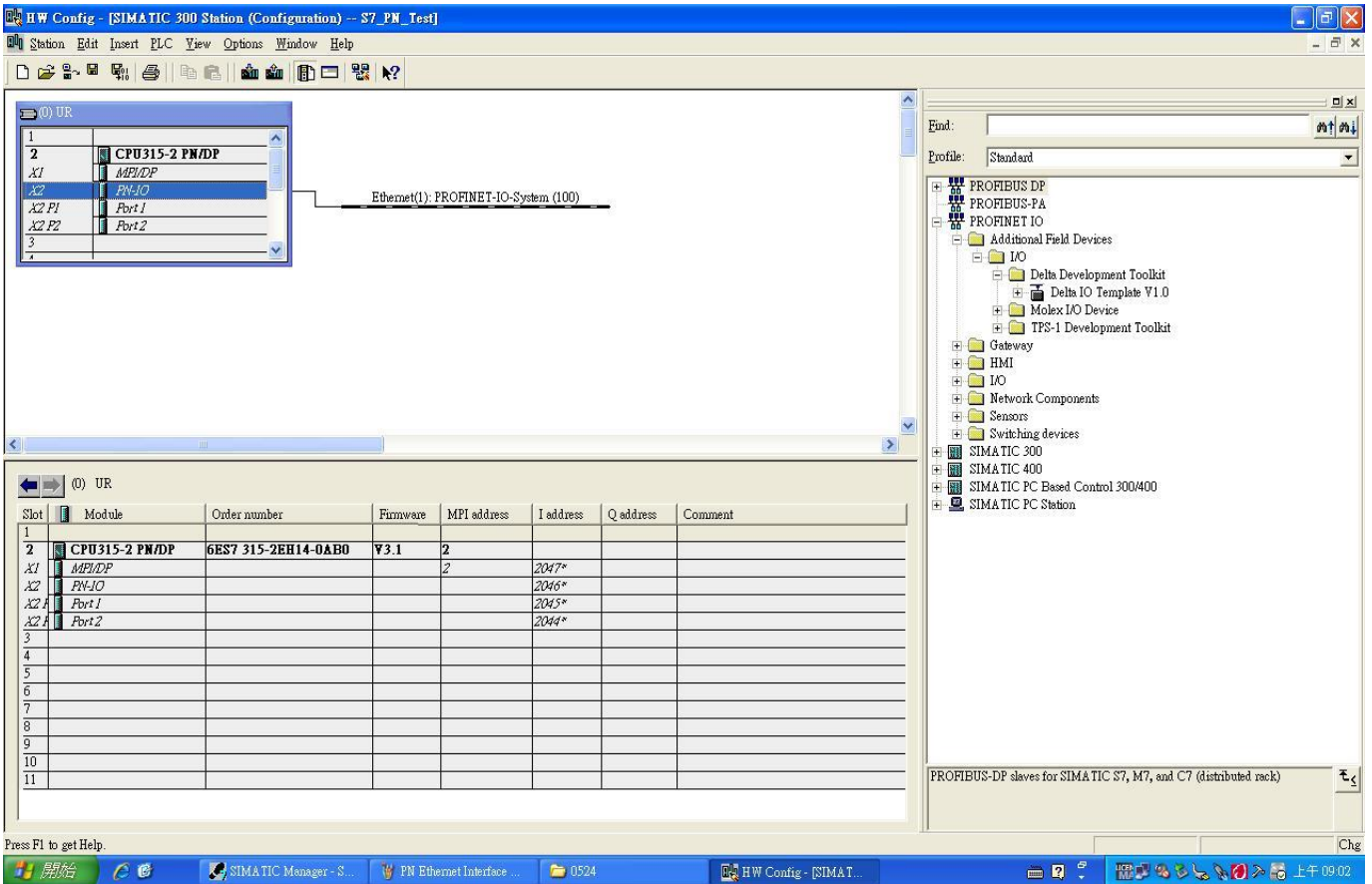

Right-click the mouse and drag Delta IO Template V1.0 to PROFINET-IO-System until the plus sign (+) appears. When it is completed, the figure below shows.

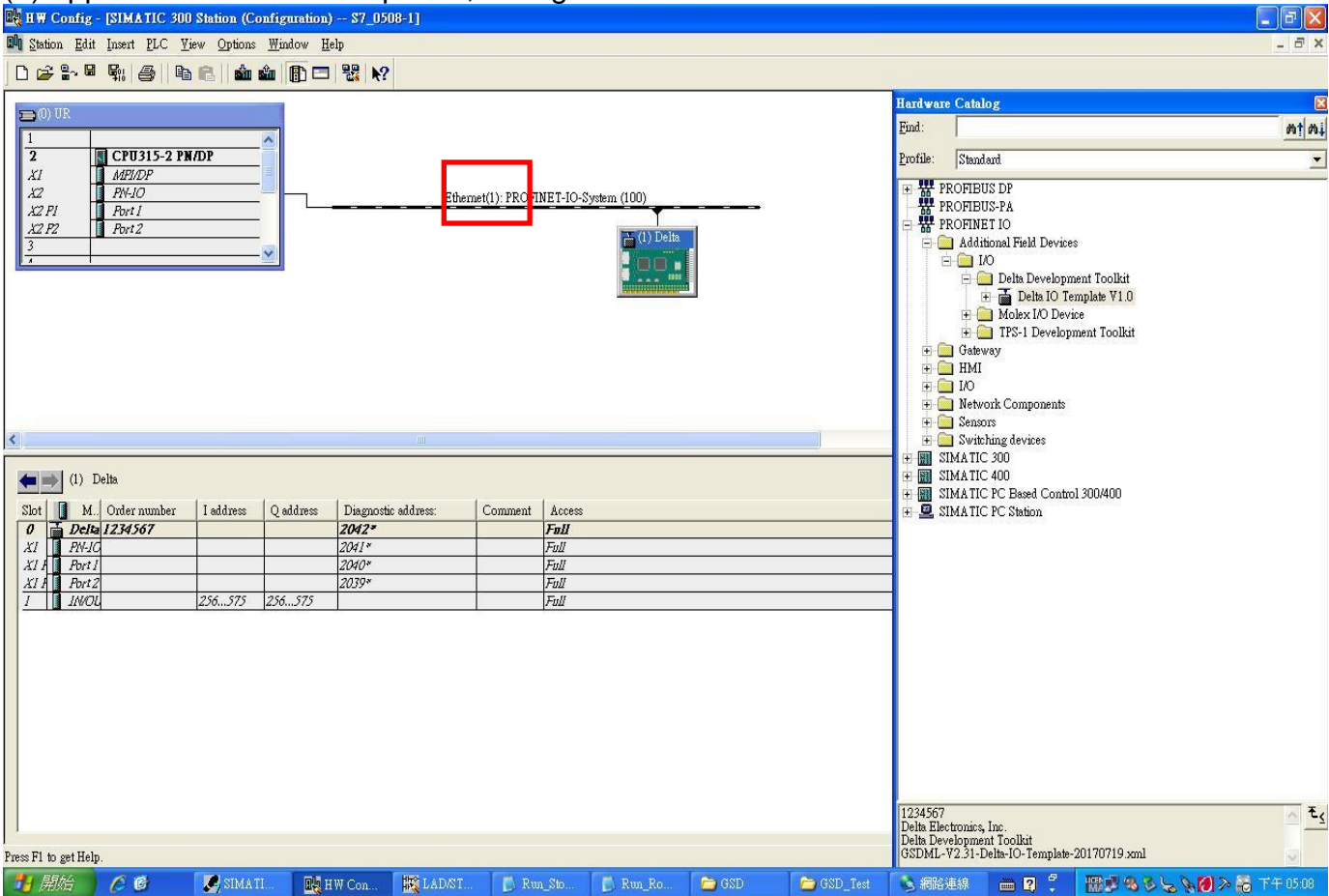

✘ Note: The host controller in PROFINET communication is identified by the name in communication cards. Therefore, if it does not match to the settings of the host controller, the communication fails.

Then, you can use **Compile** and **Download** icon to compile and download programs.

 : Compile

 : Download

When the program finishes downloading, you have to switch S7-300 to STOP Mode to be back at RUN Mode. If there is no problem with CMC-PN01 communication, the status of LED indicators for S7-300 shows as the figure below.



## ■ Testing the Start and Stop of the Drive

To verify if the host controller can control the drive through CMC-PN01, you must write the PLC program.

For STEP 7, the program-editing screen below illustrates an example of writing a program by using 60xx message format.

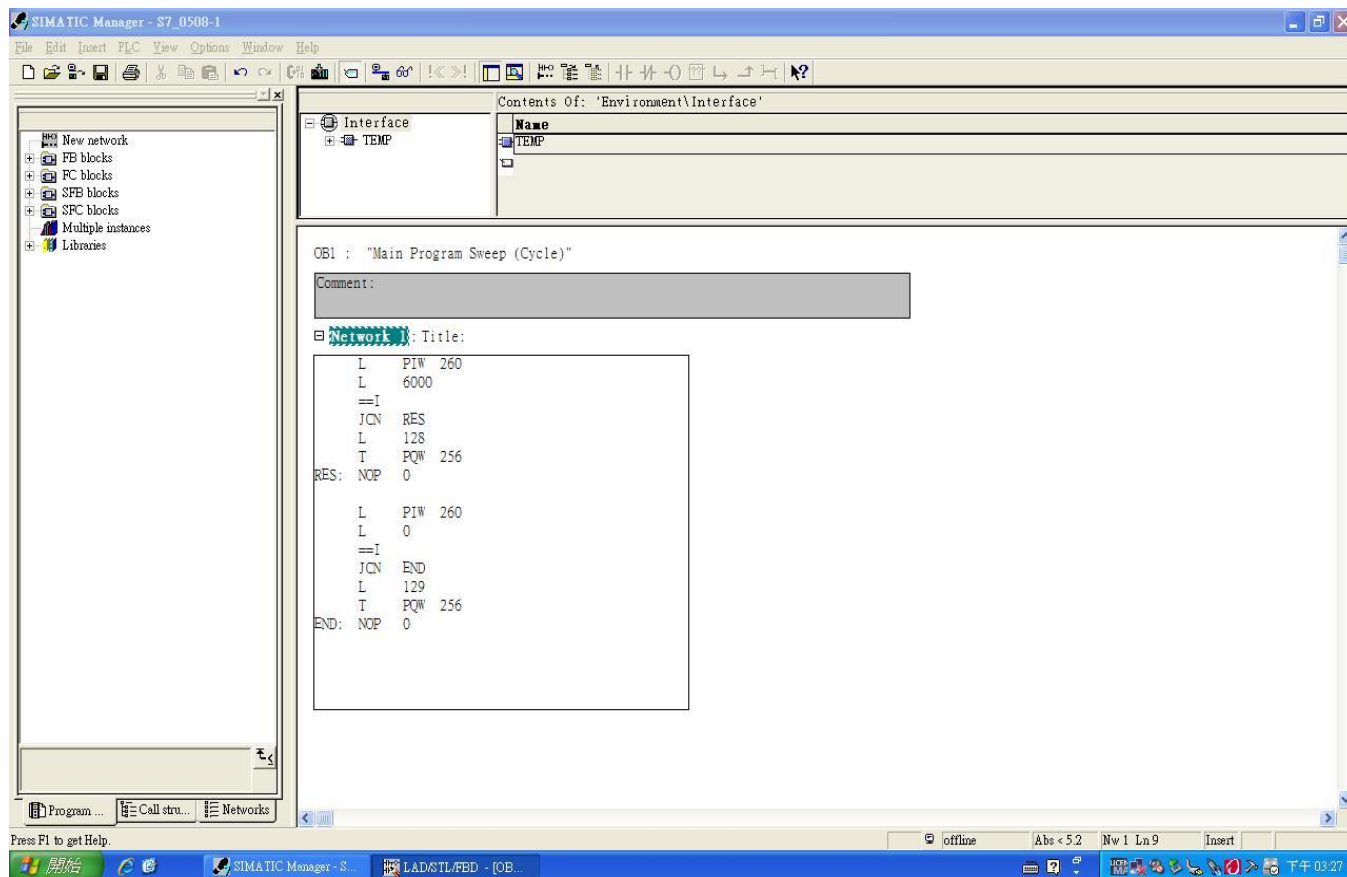

1. PIW260 means 6102H (actual output frequency).
2. PQW256 means 6000H (control word).
3. The writing of the program explains as follows.
  - OB1 Program (Main Loop) is explained as follows:
    - a. Judging if PIW260 (6102H) equals to 6000. If YES, PQW256 (6000H) equals to 128 (0x80), which means the drive stops running; if NO, go to RES label;
    - b. Judging if PIW260 (6102H) equals to 0. If YES, PQW256 (6000H) equals to 129 (0x81); if NO, go to END label;

Therefore, the drive performs continuous actions of running until stop, and then starts running again.

Below is the STEP 7 program-editing screen and an example of writing a program by using 20xx message format.

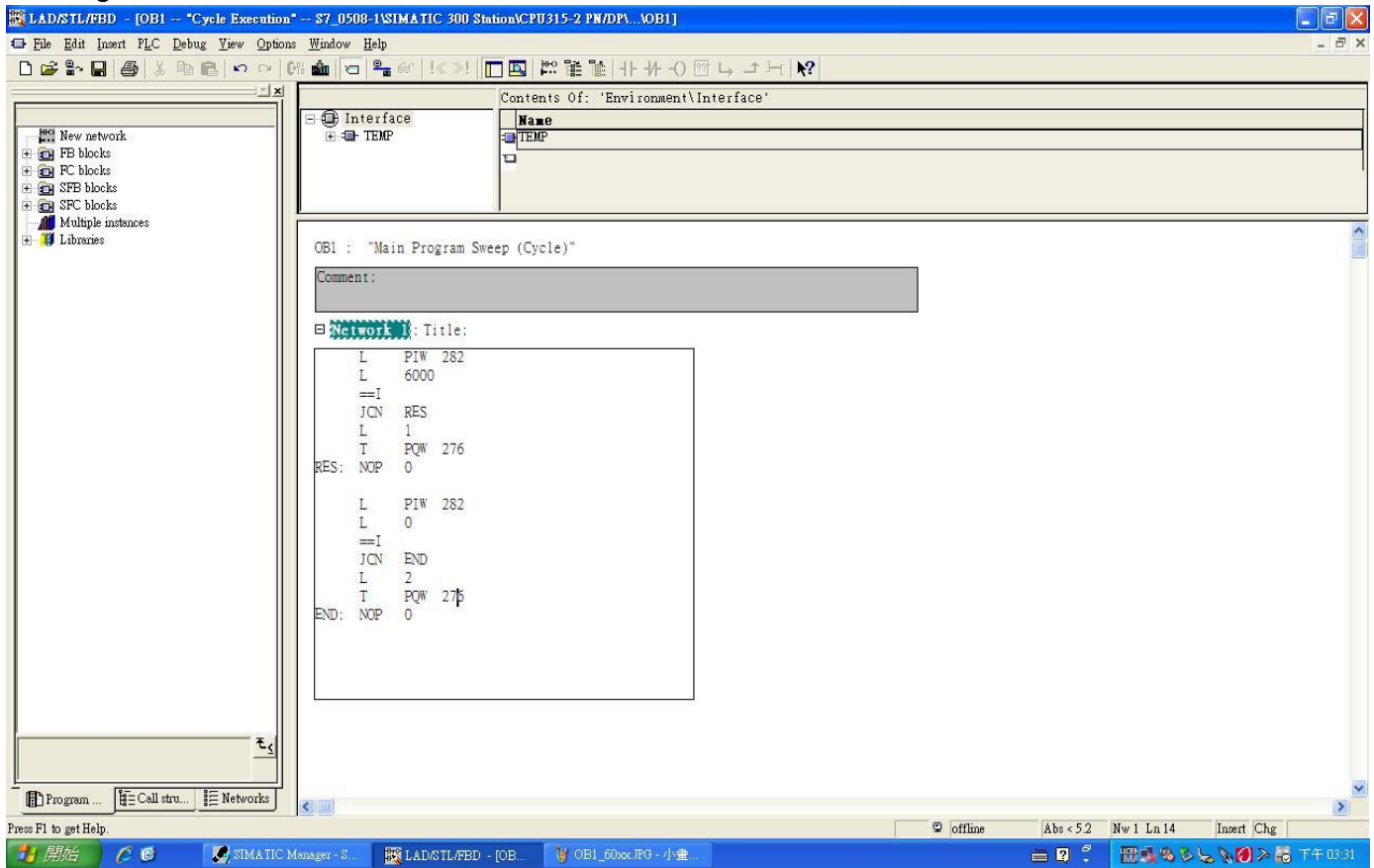

1. PIW282 means 2103H (output frequency).
2. PQW276 means 2000H (control word).
3. The writing of the program explains as follows.  
OB1 Program (Main Loop) is explained as follows:
  - a. Judging if PIW282 (2103H) equals to 6000. If YES, PQW276 (2000H) equals to 1, which means the drive stops running; if NO, go to RES label;
  - b. Judging if PIW282 (2103H) equals to 0. If YES, PQW276 (2000H) equals to 2, which means the drive starts running; if NO, go to END label;

Therefore, the drive performs continuous actions of running until stop, and then starts running again.

### 6.3 Speed Mode DEMO (S7-1500 + TIA PORTAL)

Create Project.

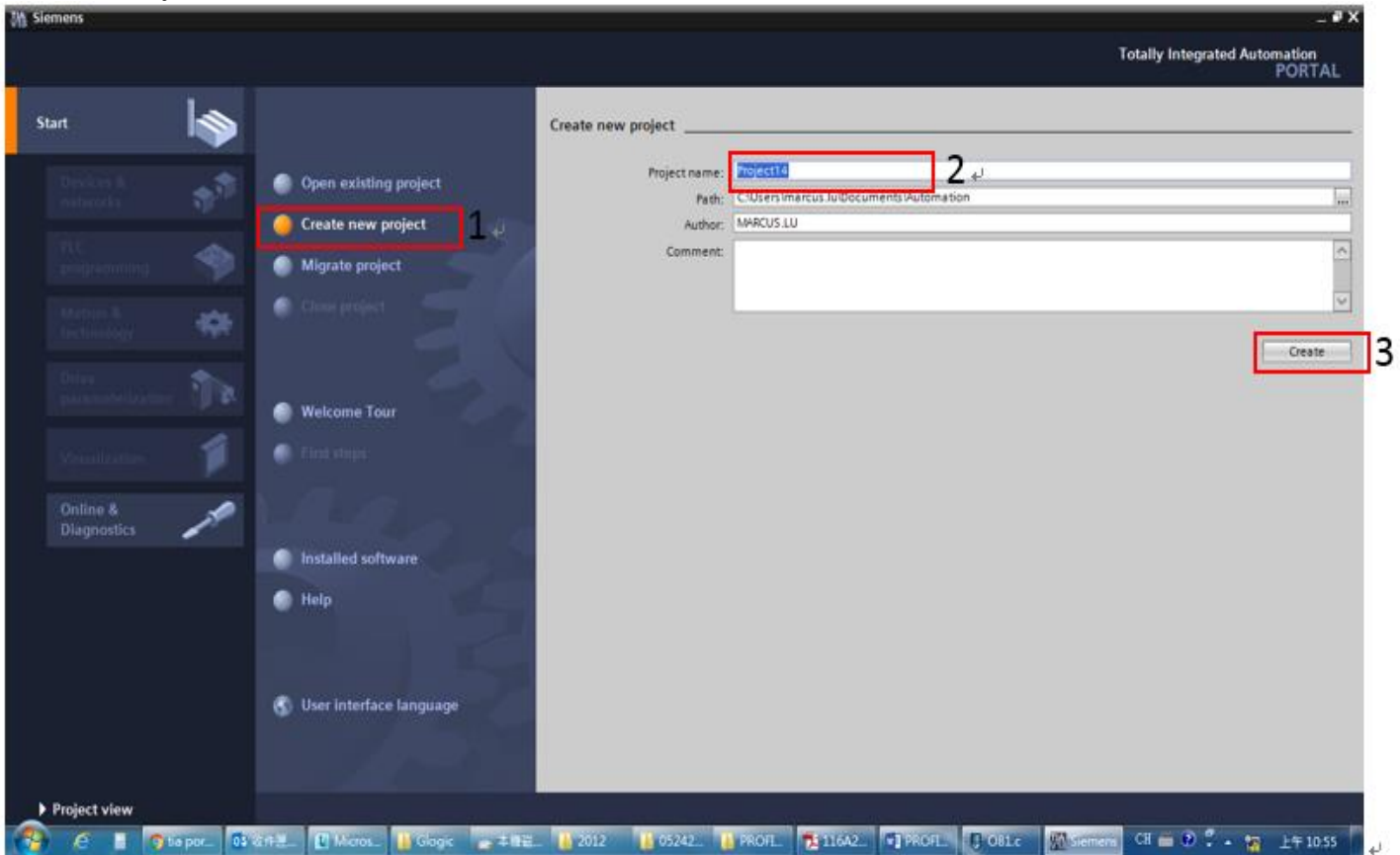

Select Project view.

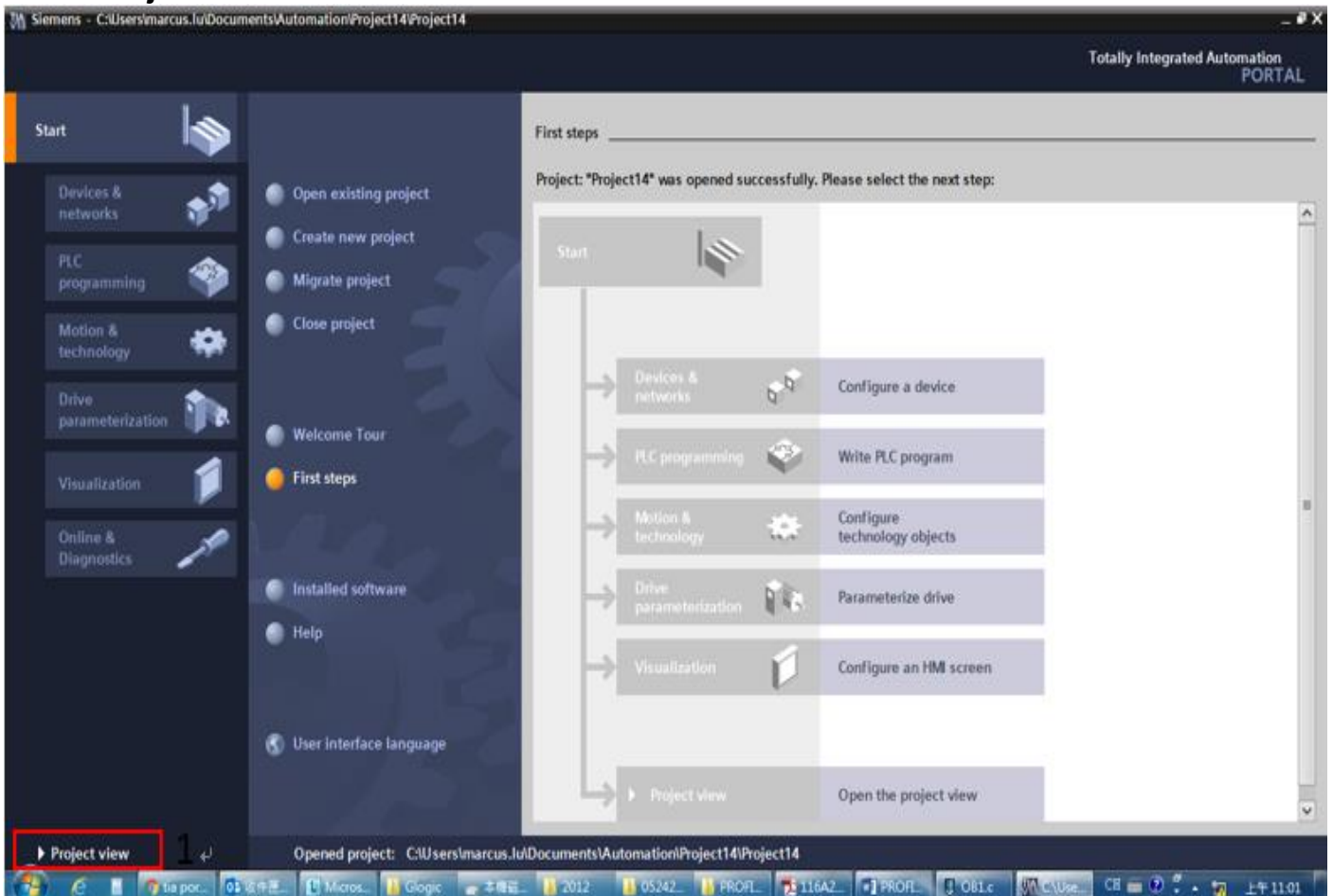



Install GSD file.

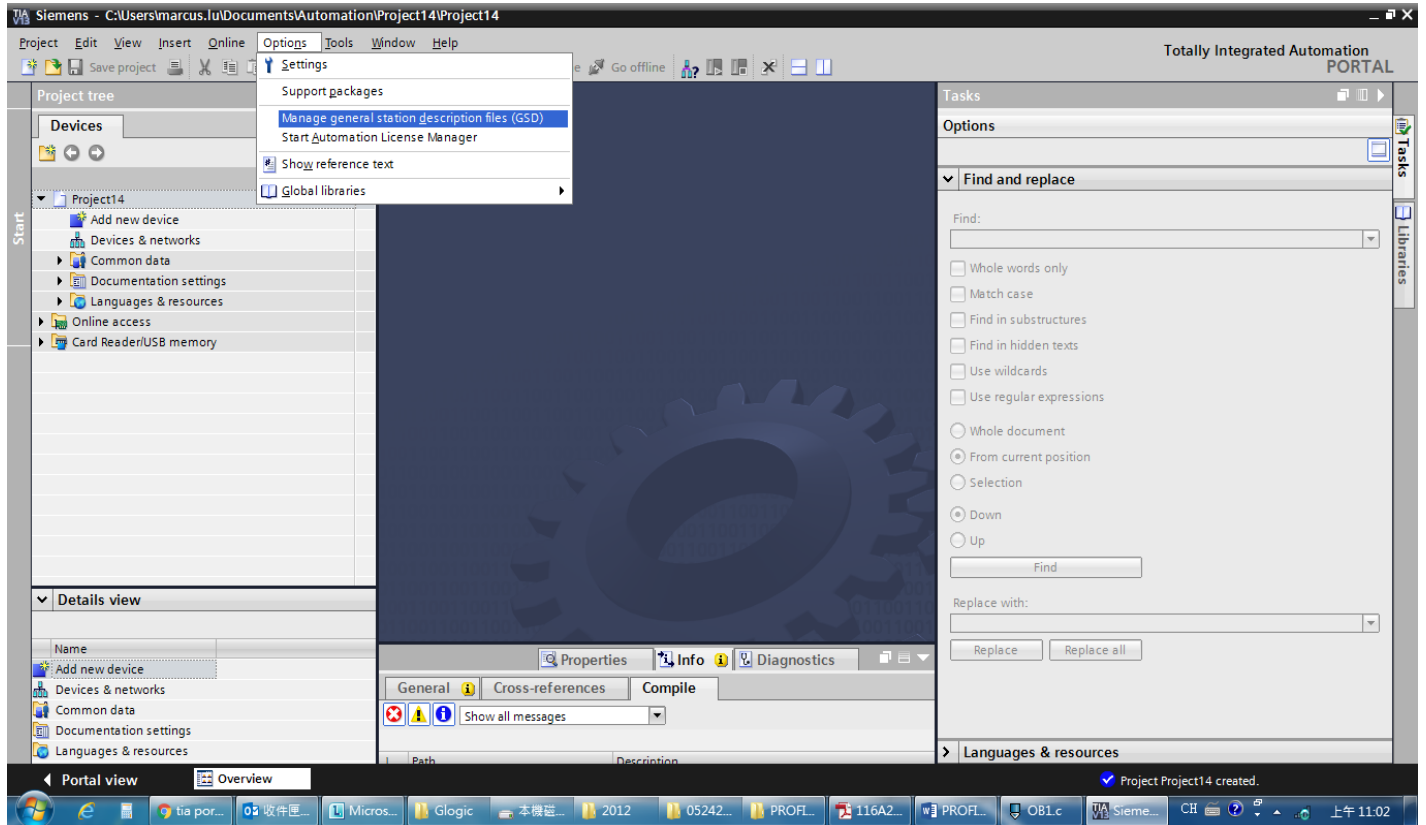

Select the path to save the GSDML file, select the GSDML file required to install, and then click **Install** button.

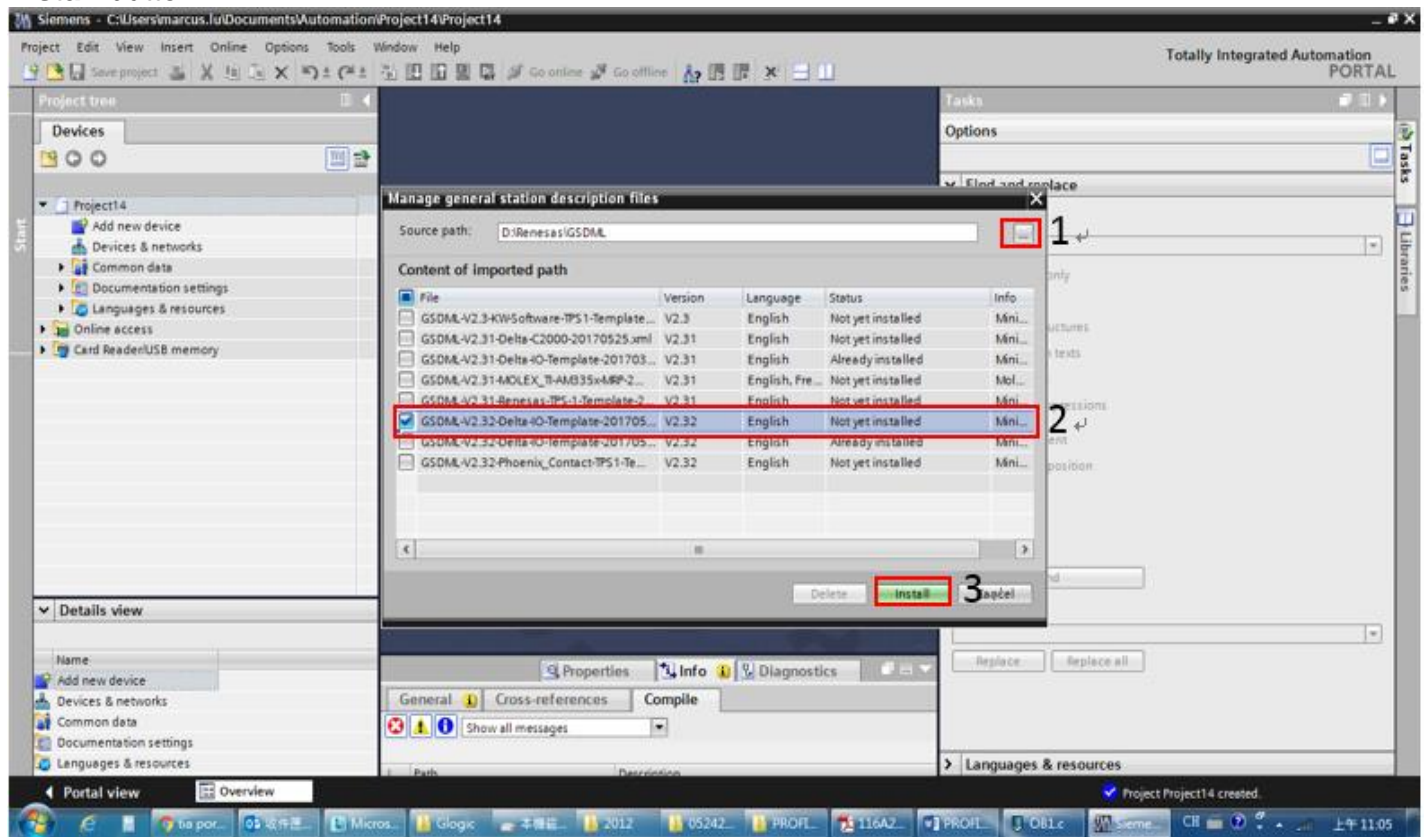

When the installation is completed, select **Devices & networks** and double-click it to check if the screen below displays. If the following screen displays, the installation is completed. If not, you must install again.

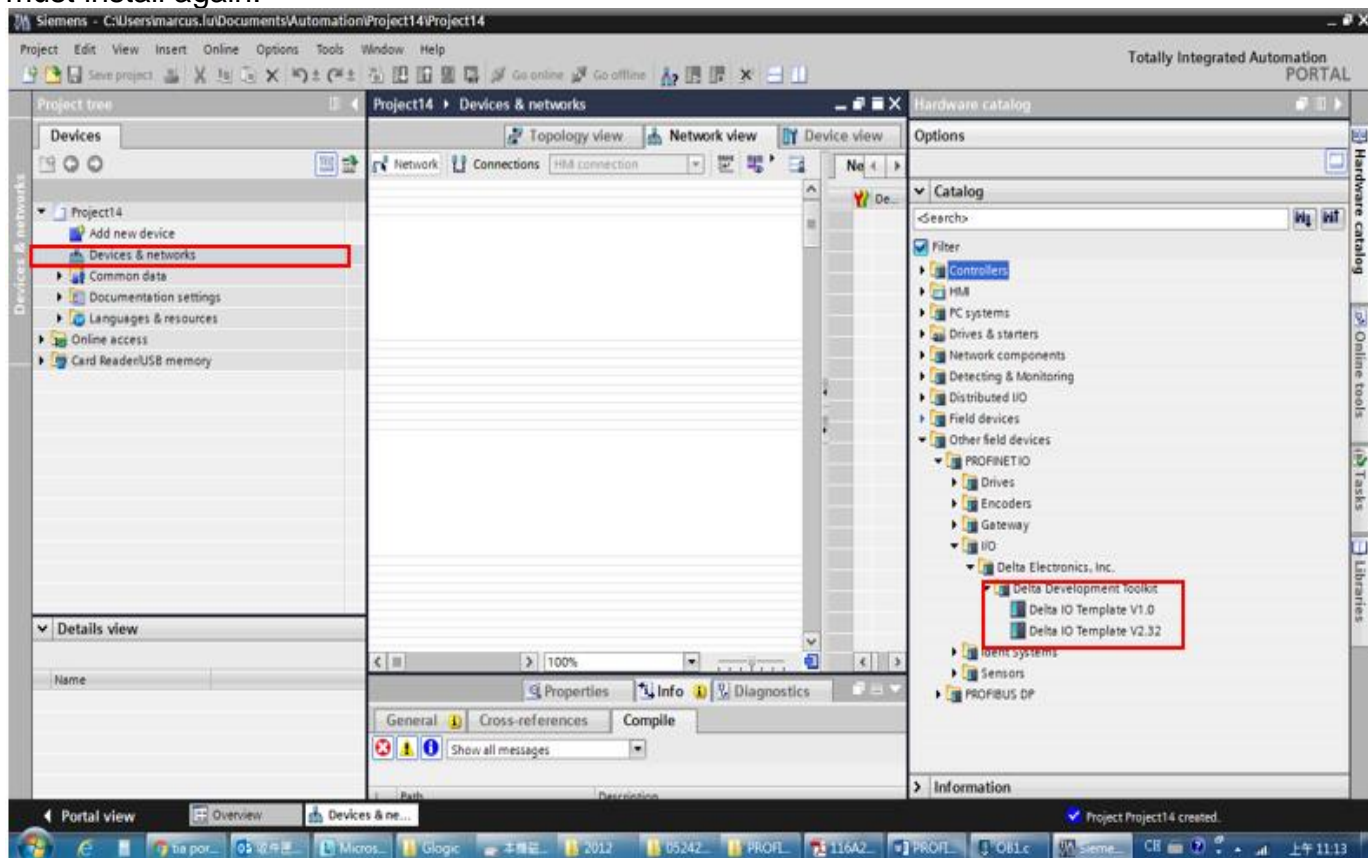

Select and double-click **Add new device**, the figure below displays.

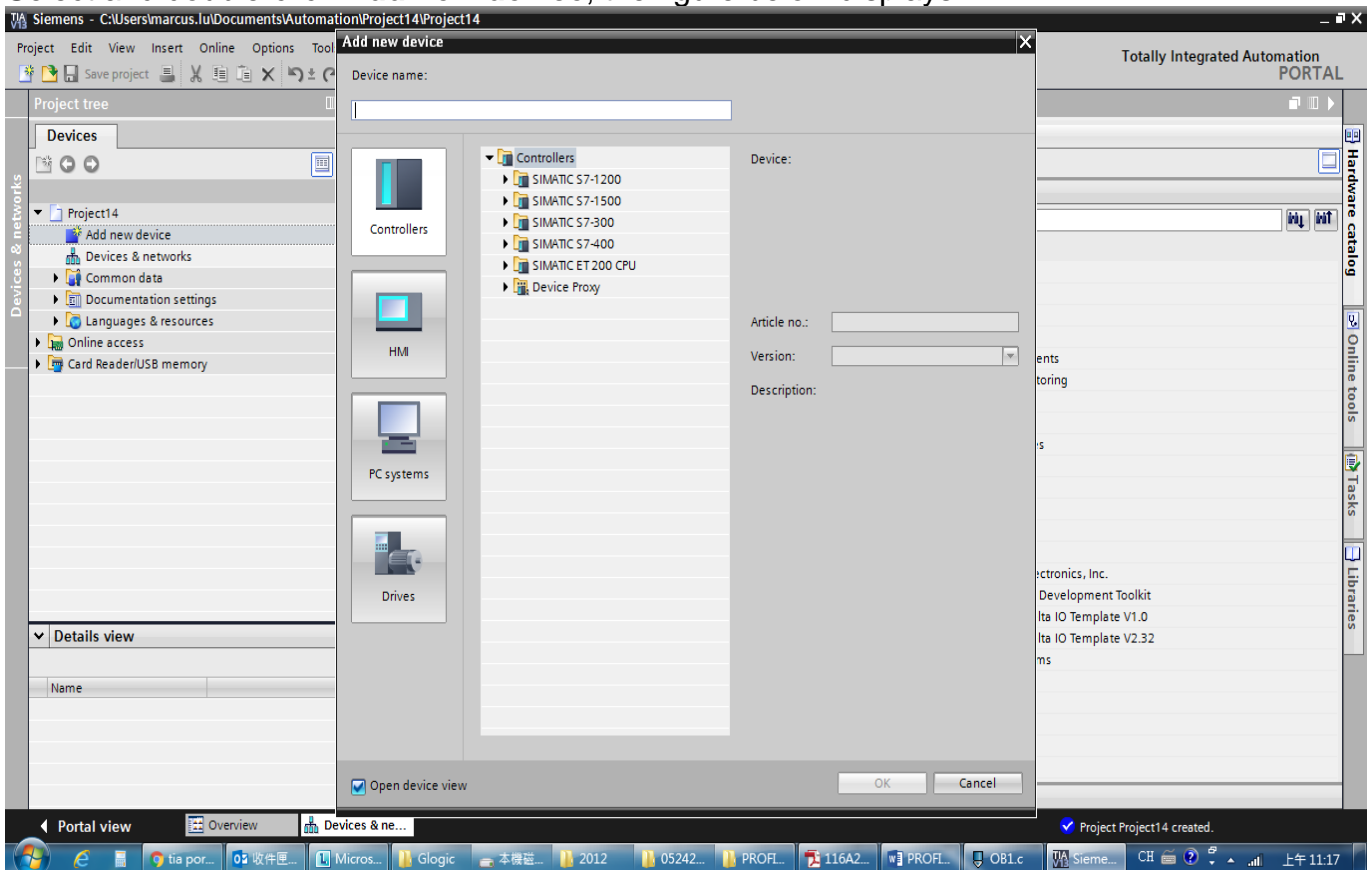

Select PLC's article No. and firmware version.

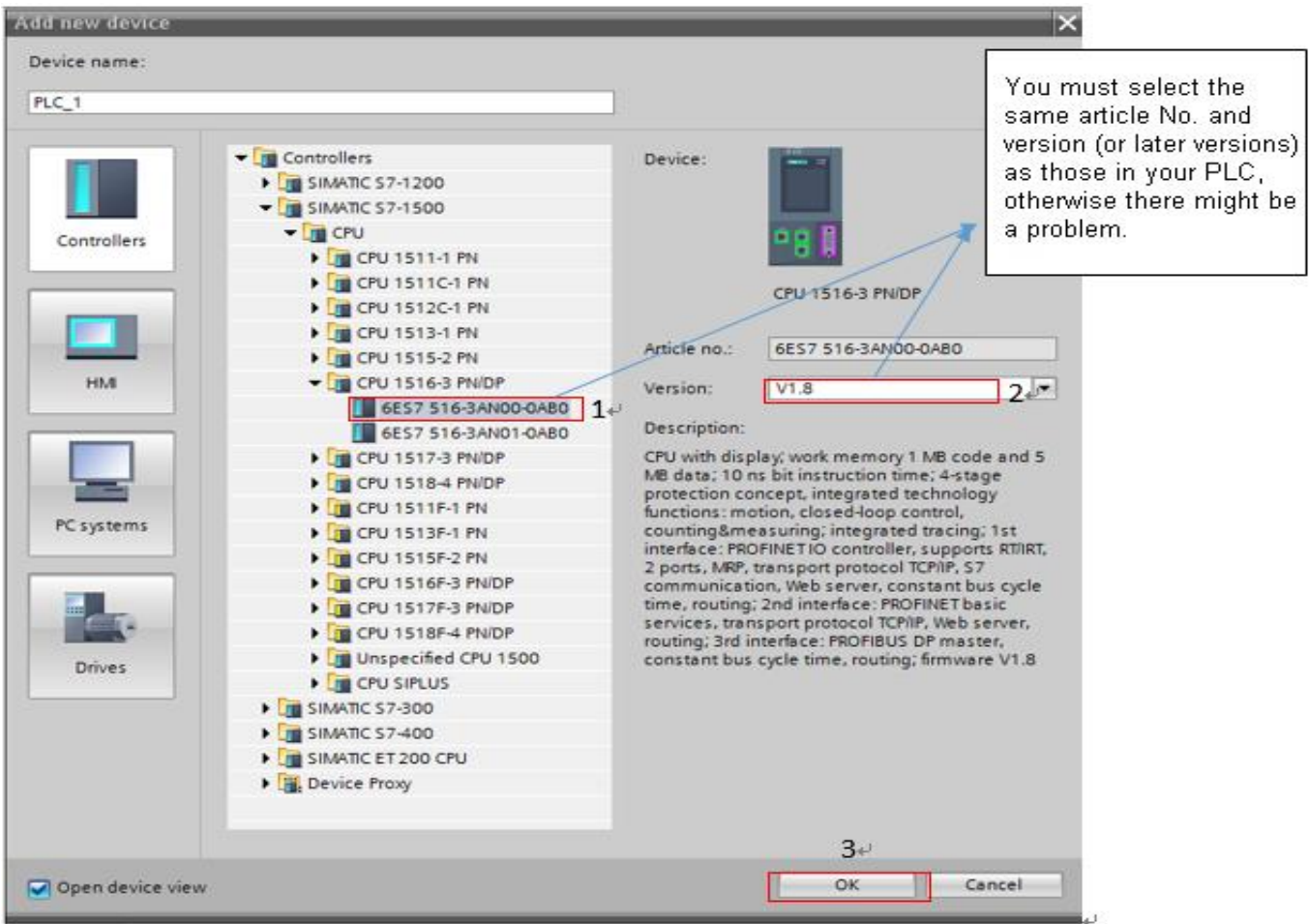

After you click **OK** button, a screen displays as shown in the figure below.

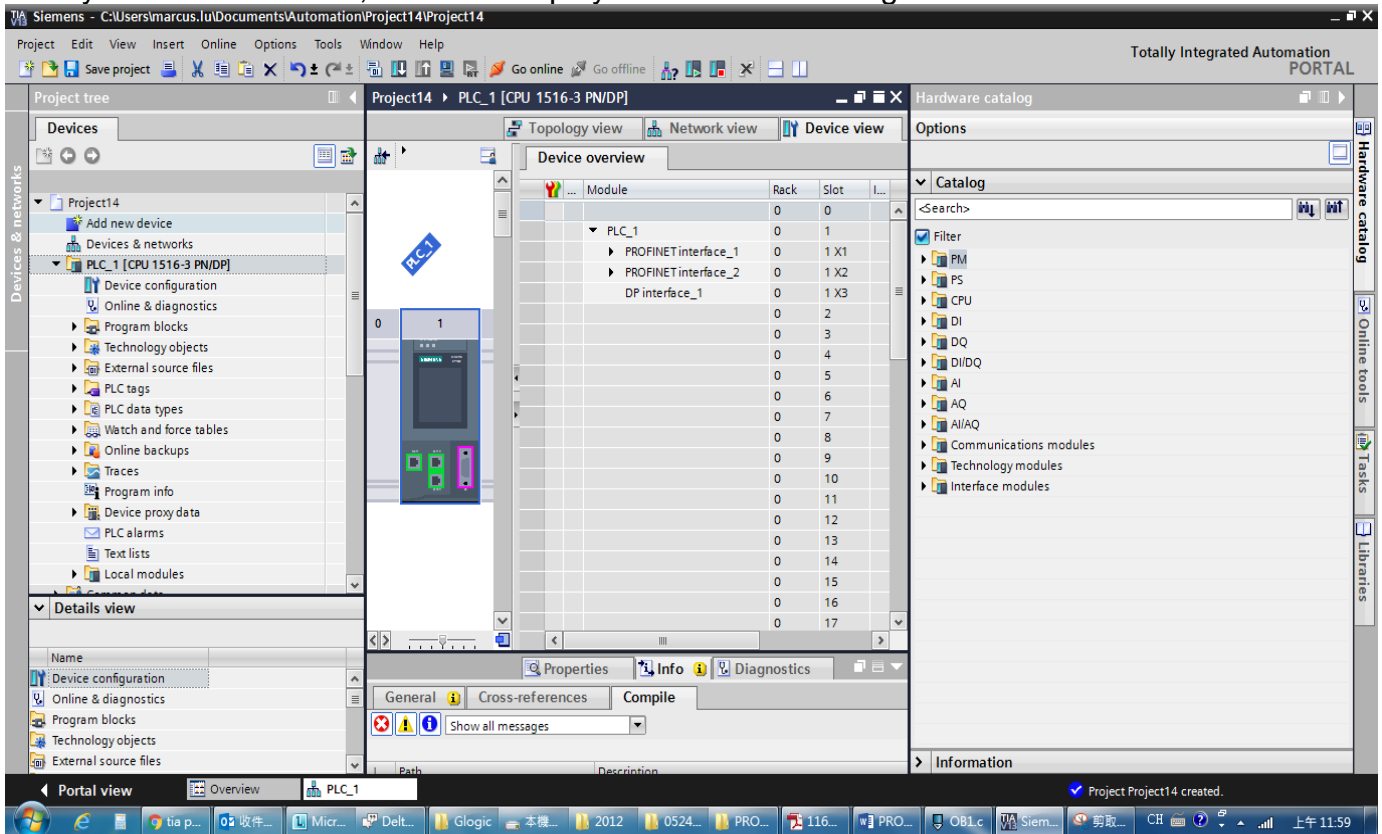



In the screen above, select **Network view**, a screen displays as shown in the figure below.

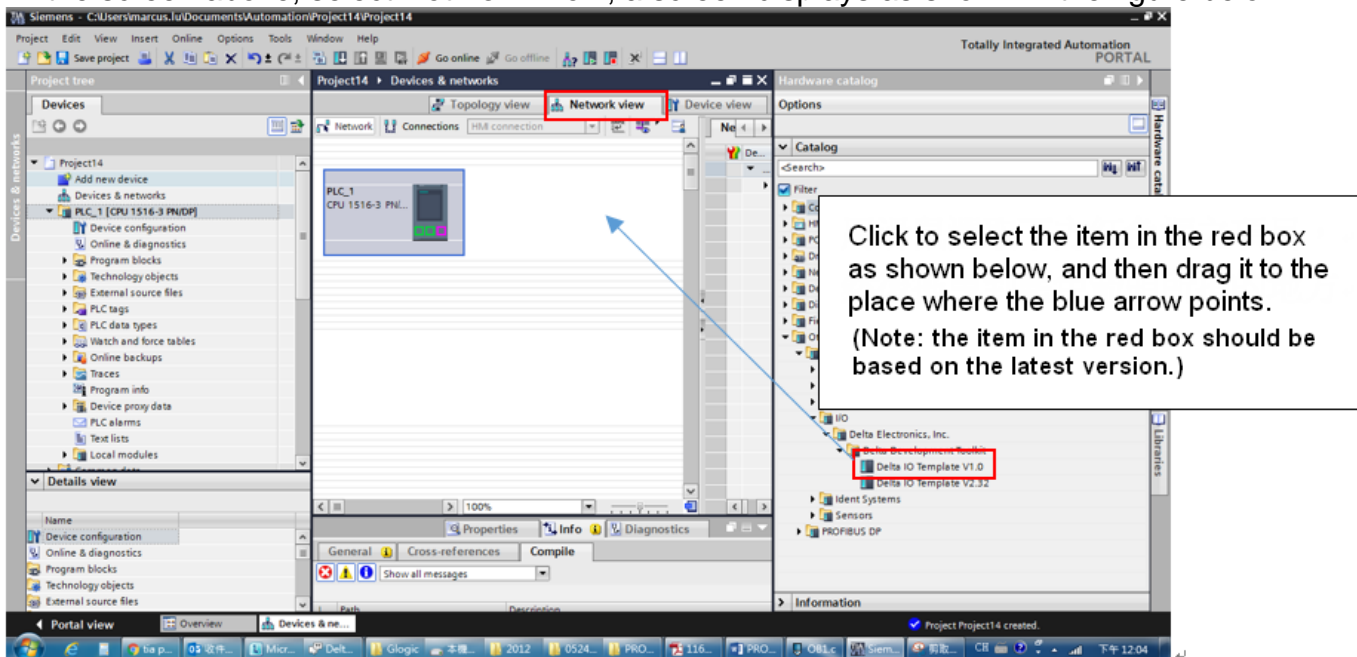

When the dragging is completed, a screen displays as shown in the figure below.

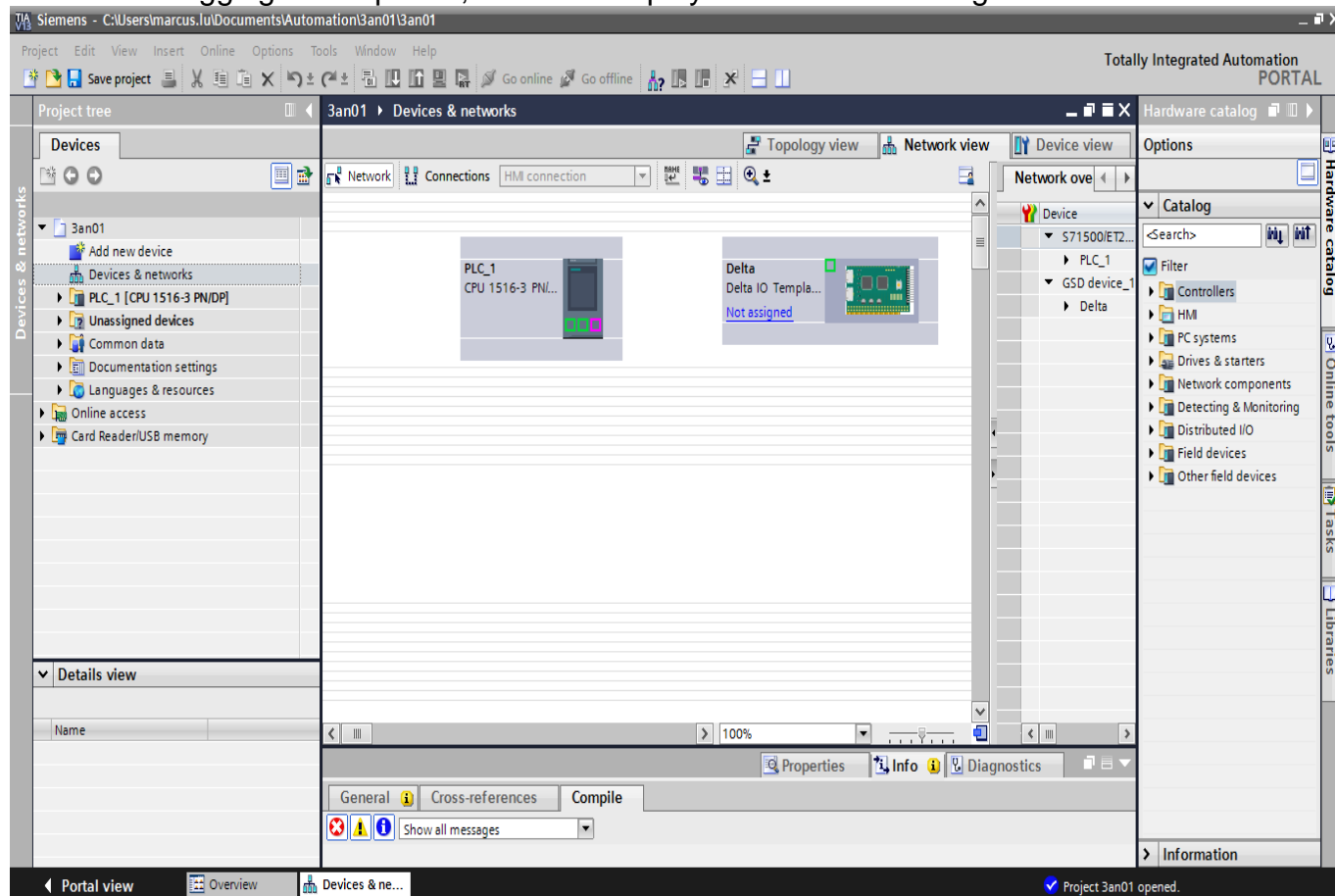

As the figure below shows, move the mouse to position 1 and drag it to draw a line to position 2.

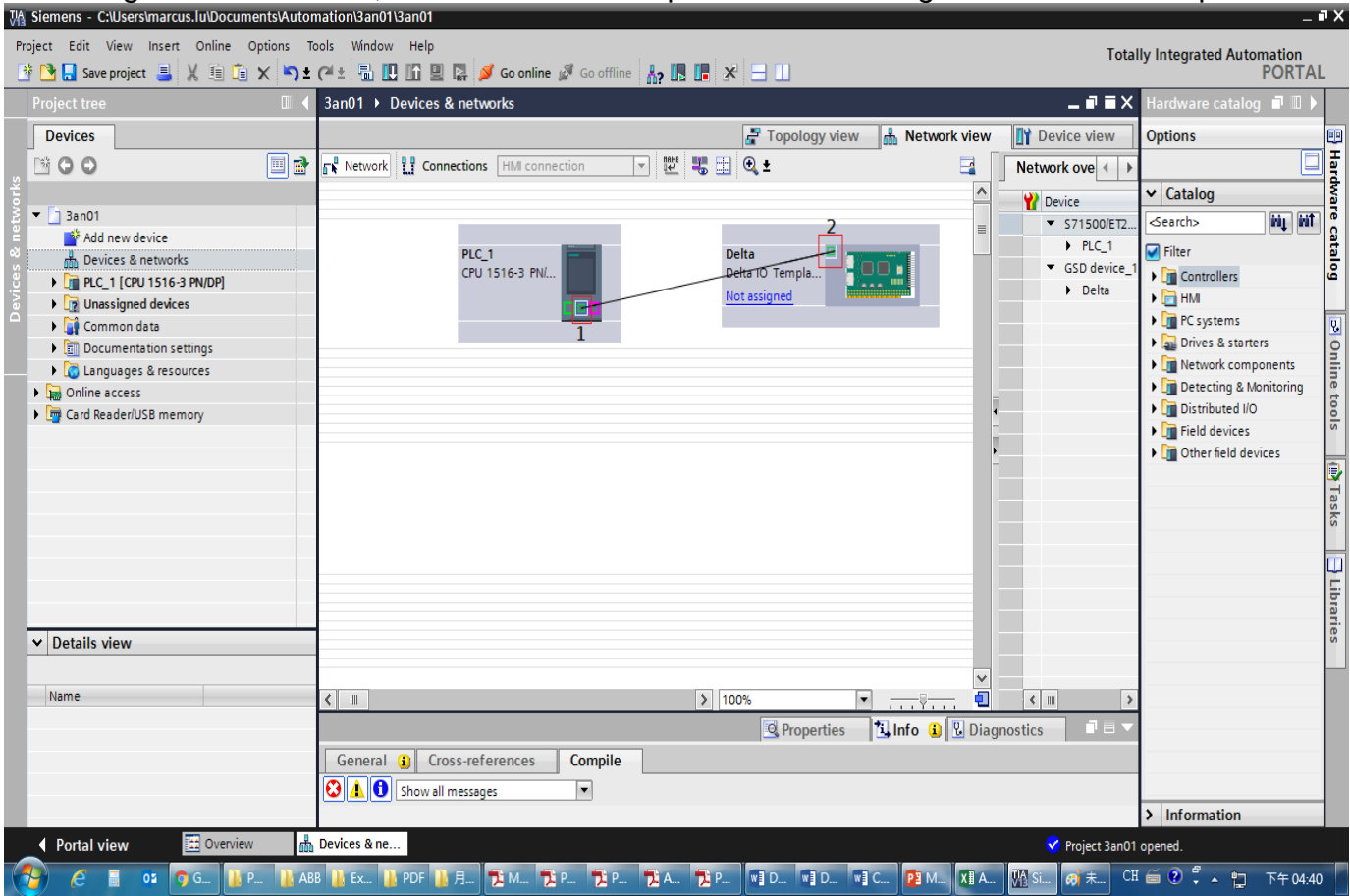

Then, a screen displays as shown in the figure below. If not, remove the drawing line and try another network interface. (It must be exactly the same as the figure below shows so the PROFINET framework is successfully completed.)

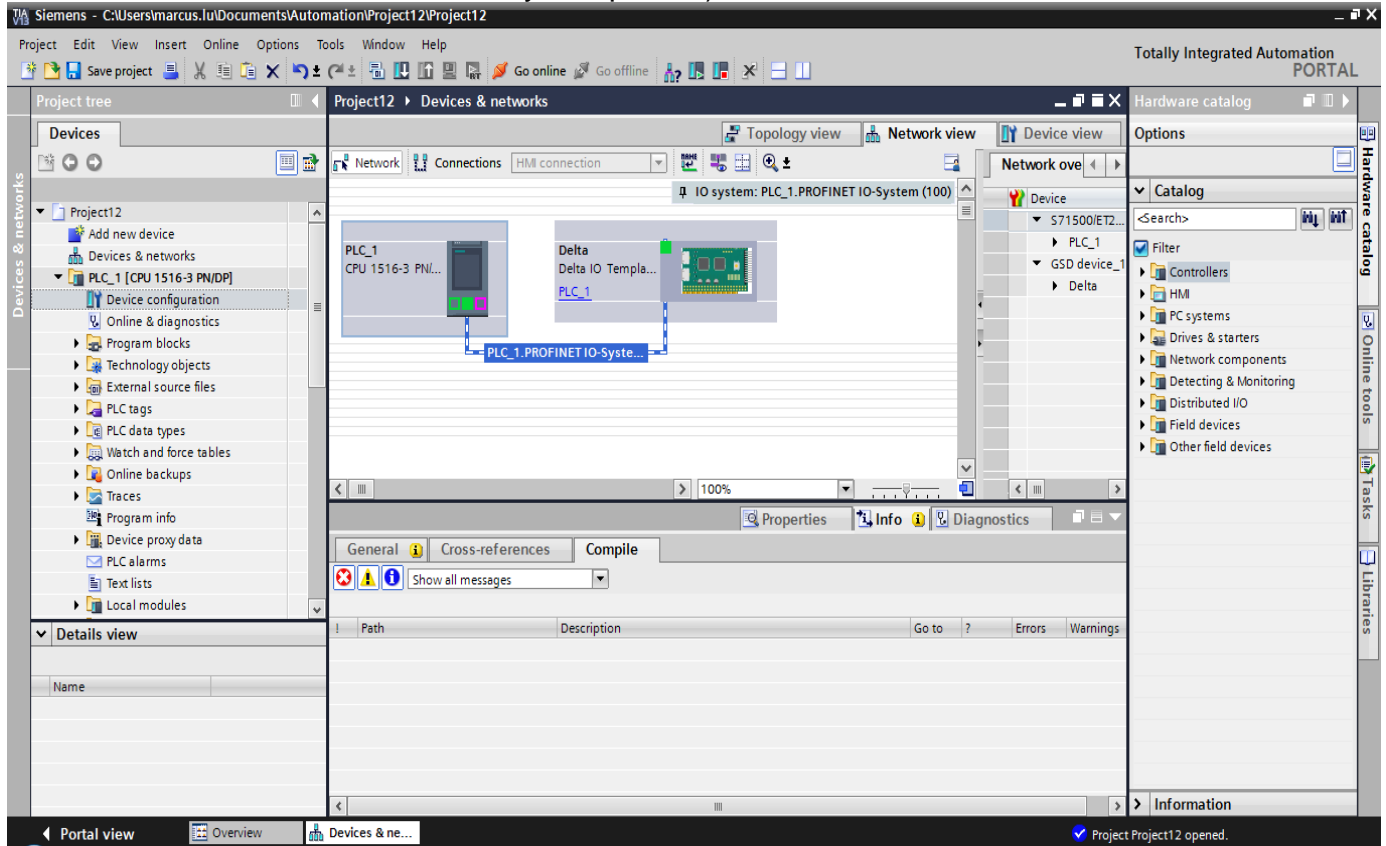

Now you can start to test the connection. Follow the steps as shown in the figure below to compile and download.

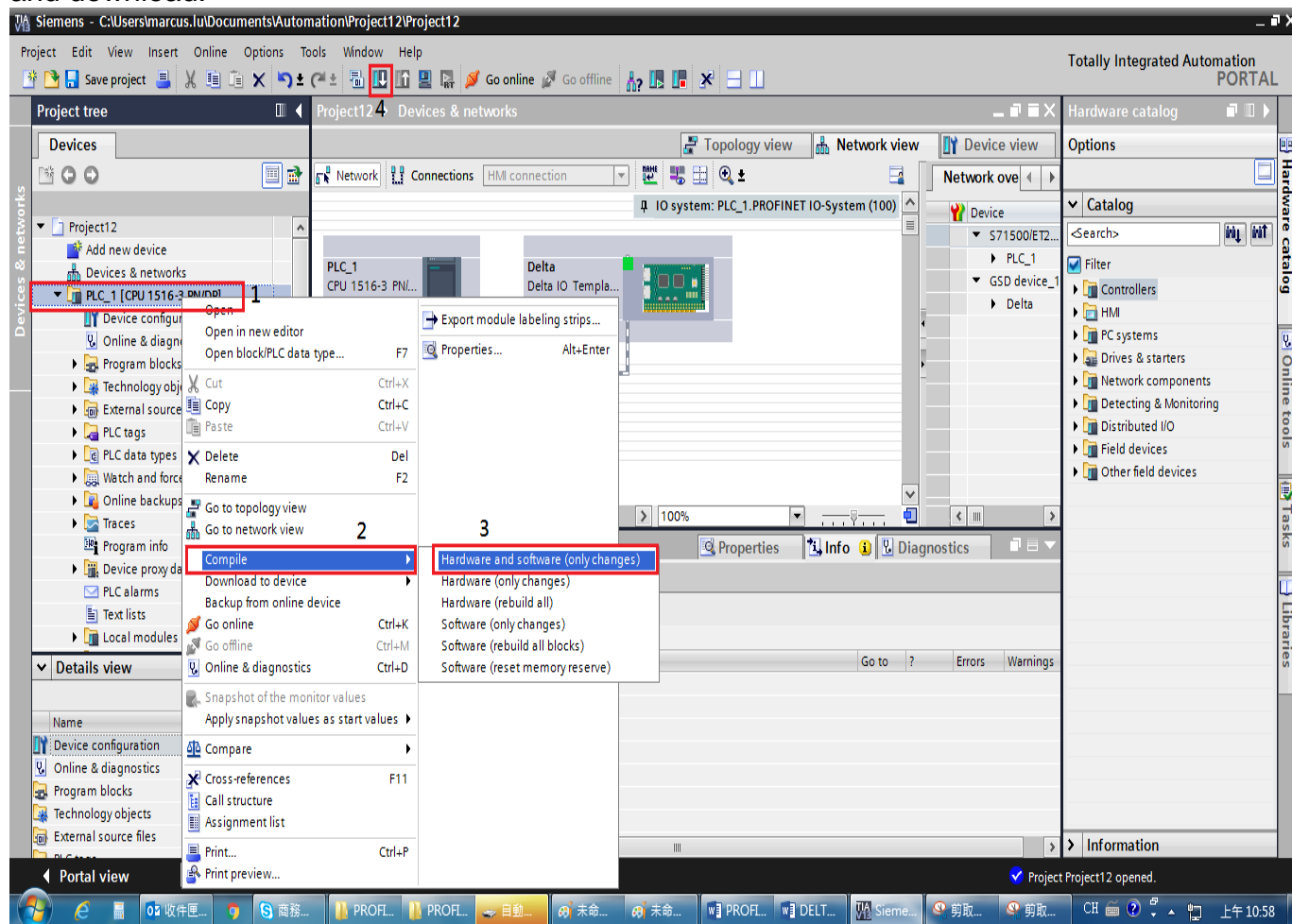

When S7-1500 is successfully connected, the status of LED and LCD panel shows as the figure below.



■ Testing the Start and Stop of the Drive

To verify if the host controller can control the drive through CMC-PN01, you must write PLC program.

For TIA PORTAL, the program-editing screen below illustrates an example of writing a program by using 60xx message format.

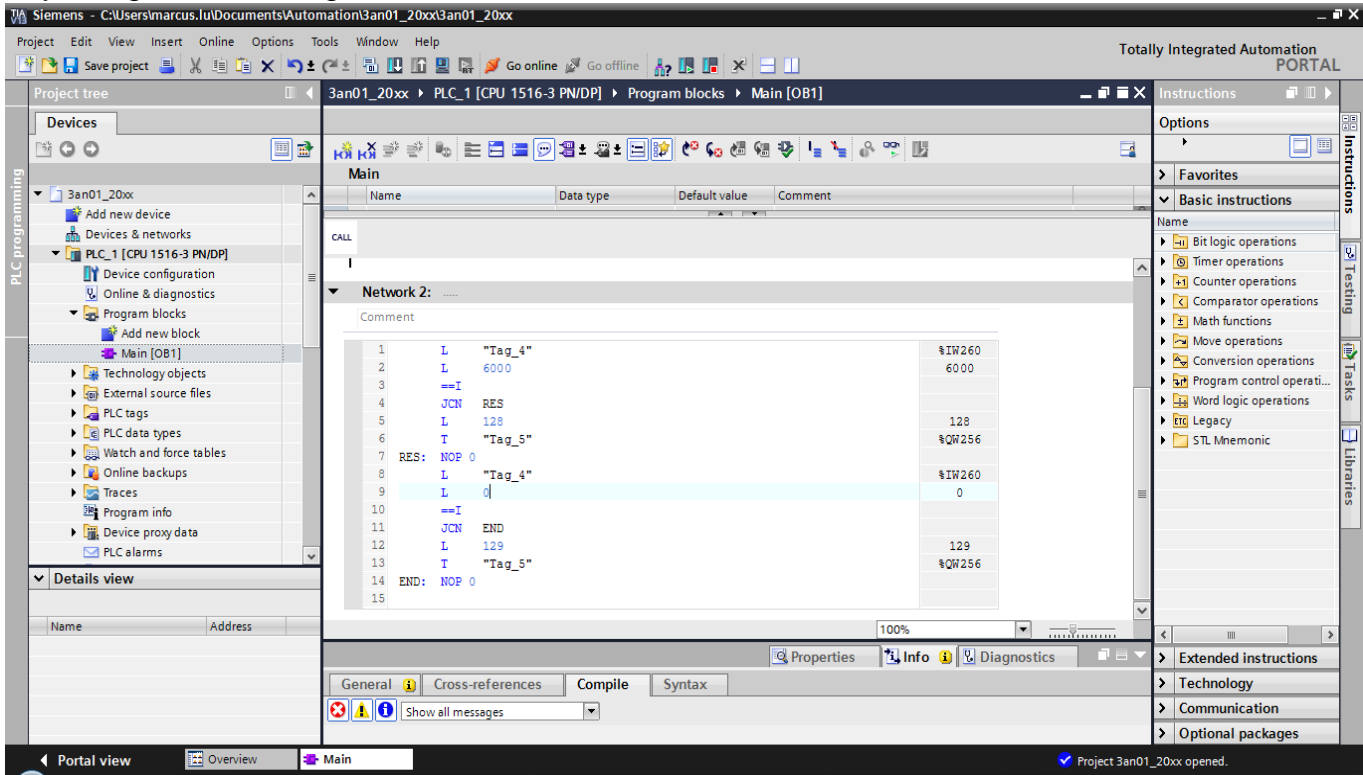

1. IW260 means 6102H (actual output frequency).
2. QW256 means 6000H (control word).
3. The writing of the program explains as follows.  
 OB1 Program (Main Loop) is explained as follows:
  - a. Judging if IW260 (6102H) equals to 6000. If YES, PQW256 (6000H) equals to 128 (0x80), which means the drive stops running; if NO, go to RES label;
  - b. Judging if PIW260 (6102H) equals to 0. If YES, PQW256 (6000H) equals to 129 (0x81); if NO, go to END label;

Therefore, the drive performs continuous actions of running until stop, and then starts running again.

Below is the TIA PORTAL program-editing screen and an example of writing a program by using 20xx message format.

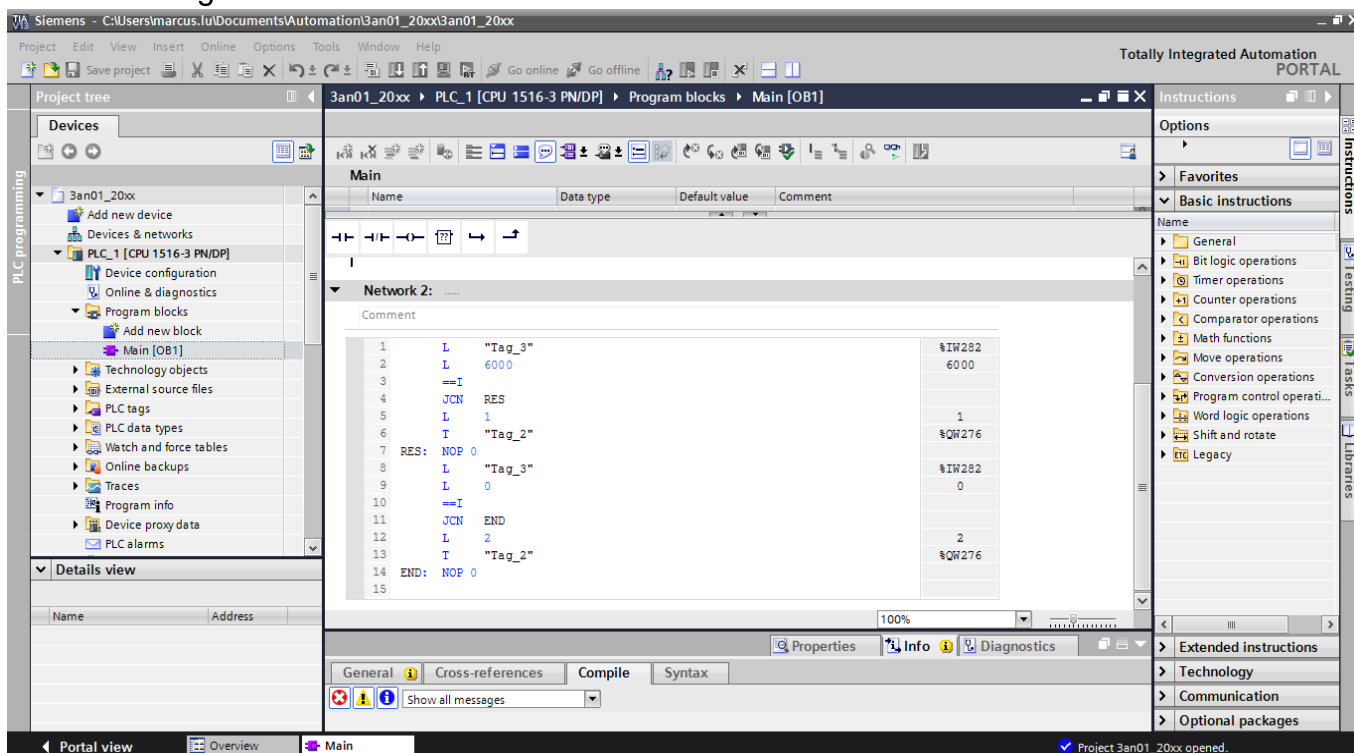

1. IW282 means 2103H (output frequency).
2. QW276 means 2000H (control word).
3. The writing of the program explains as follows.
  - OB1 Program (Main Loop) is explained as follows:
    - a. Judging if IW282 (2103H) equals to 6000. If YES, QW276 (2000H) equals to 1, which means the drive stops running; if NO, go to RES label;
    - b. Judging if IW282 (2103H) equals to 0. If YES, QW276 (2000H) equals to 2, which means The drive starts running; if NO, go to END label;

Therefore, the drive performs continuous actions of running until stop, and then starts running again.



## 6.4 Demonstration of Reading/Writing Synchronous and Asynchronous Parameters (S7-300 + TIA PORTAL)

### ■ Settings for Reading and Writing Synchronous Parameters of the Drive

The following example is demonstrated by using Siemens CPU315-2 PN/DP and TIA Portal V13 SP1.

1. Follow the four steps as shown in the figure below to open Module Parameters.

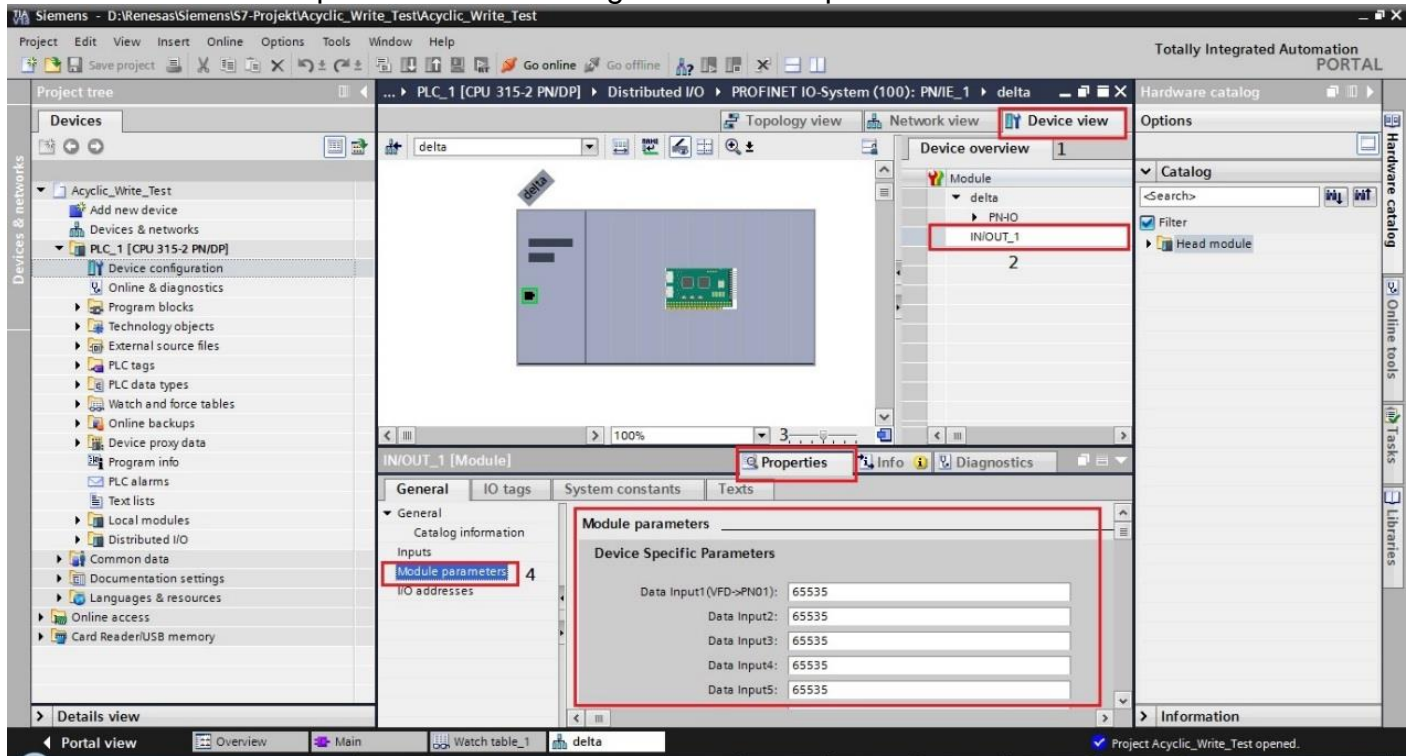

2. The figure below shows a complete parameter table. You can synchronously read or write the parameters of the drive by setting up this table. If the value of the parameters is 65535(0xFFFF), there is no parameter reading or writing.

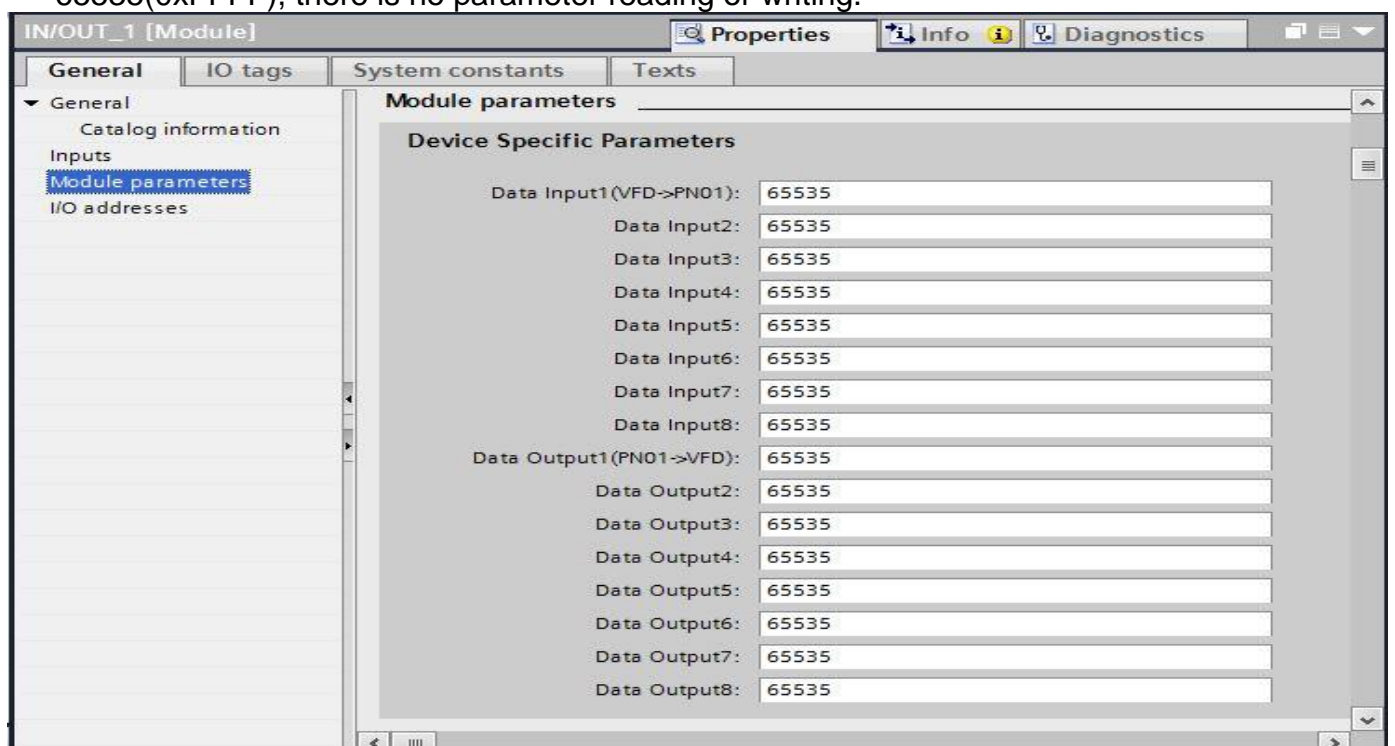

3. The figure below shows that you read Pr.01-00, Pr.01-10 and Pr.09-00 and write Pr.01-00 and Pr.09-00.

Device Specific Parameters		
Data Input1(VFD->PN01):	256	01-00(0x0100)
Data Input2:	266	01-10(0x010A)
Data Input3:	65535	
Data Input4:	65535	
Data Input5:	65535	
Data Input6:	65535	
Data Input7:	65535	
Data Input8:	2304	09-00(0x0900)
Data Output1(PN01->VFD):	256	01-00(0x0100)
Data Output2:	65535	
Data Output3:	65535	
Data Output4:	65535	
Data Output5:	65535	
Data Output6:	65535	
Data Output7:	65535	
Data Output8:	2304	09-00(0x0900)

Thus, to synchronously read or write the drive parameters through the PLC program, simply add 40 bytes to the start address of the I/O address. The added value is the home position of the parameter table. Take the figure above as an example, to read the values from Pr.01-00 in the PLC program, read %IW296:P. Similarly, to write the values in Pr.01-00 in the PLC program, write %QW296:P.

If you do not know the start address of the I/O address, refer to the figure below and follow the four steps to open the I/O Address.

The screenshot shows the Siemens TIA Portal interface. The 'Device view' tab is selected, displaying a 'delta' module with 'IN/OUT\_1' selected. The 'Properties' window is open, showing the 'I/O addresses' section with 'Start address: 256' and 'End address: 315' highlighted by red boxes. The 'I/O addresses' section is also highlighted by a red box in the left sidebar.

4. After you finish setting up the parameter table, recompile the programs and download them to the PLC program, and then reboot the drive to make CMC-PN01 receive the updated parameter settings.
5. When CMC-PN01 is connected to the PLC program successfully, you can test the reading or writing of the set parameter by using the Watch Table. The Watch Table shows as the figure below.

Follow the four steps as shown below to verify if the settings for the parameter table are workable and if reading or writing the drive parameters is successful (can be used with the keypad to verify).

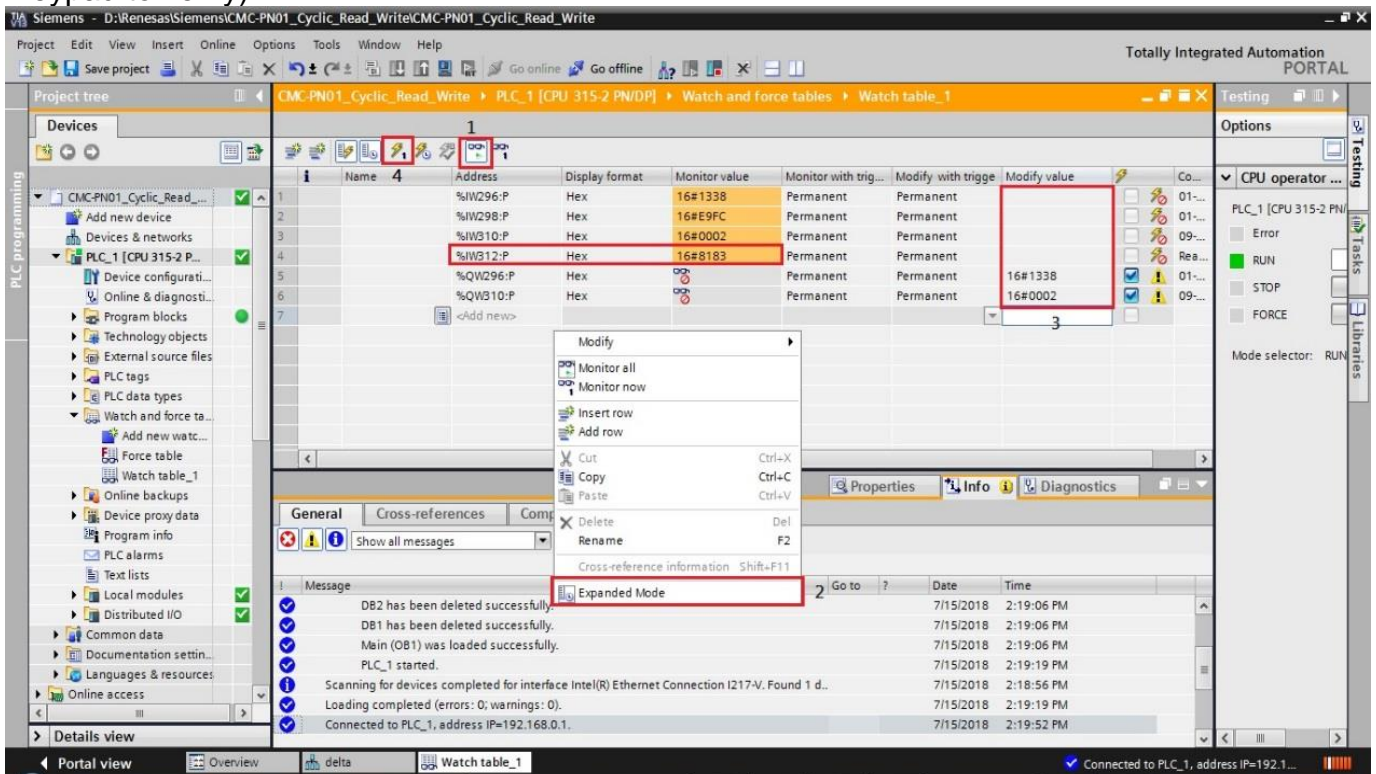

- ✘ Note: The figure above shows that %IW312 is the status value returned when the parameter table reads or writes the parameters. Low byte is the status value of reading, whereas high byte is the status value of writing. Take the figure above as an example, if the status value is 0x8183, the values of 1, 2, and 8 in the parameter table are successfully read and the values of 1 and 8 are successfully written. Thus, as can be seen, the success or failure of the parameter reading/writing depends on this status value.
- ✘ %IW312 = I/O start address + 56 (the I/O start address in this example is 256).
- ✘ If you do not need to write the parameters synchronously (with time constraint), it is suggested to write the parameters asynchronously (without time constraint).



## ■ Settings for Reading and Writing Asynchronous Parameters of the Drive

Asynchronous writing:

1. Follow the steps as shown in the figure below, open OB1 and Insert STL Network.

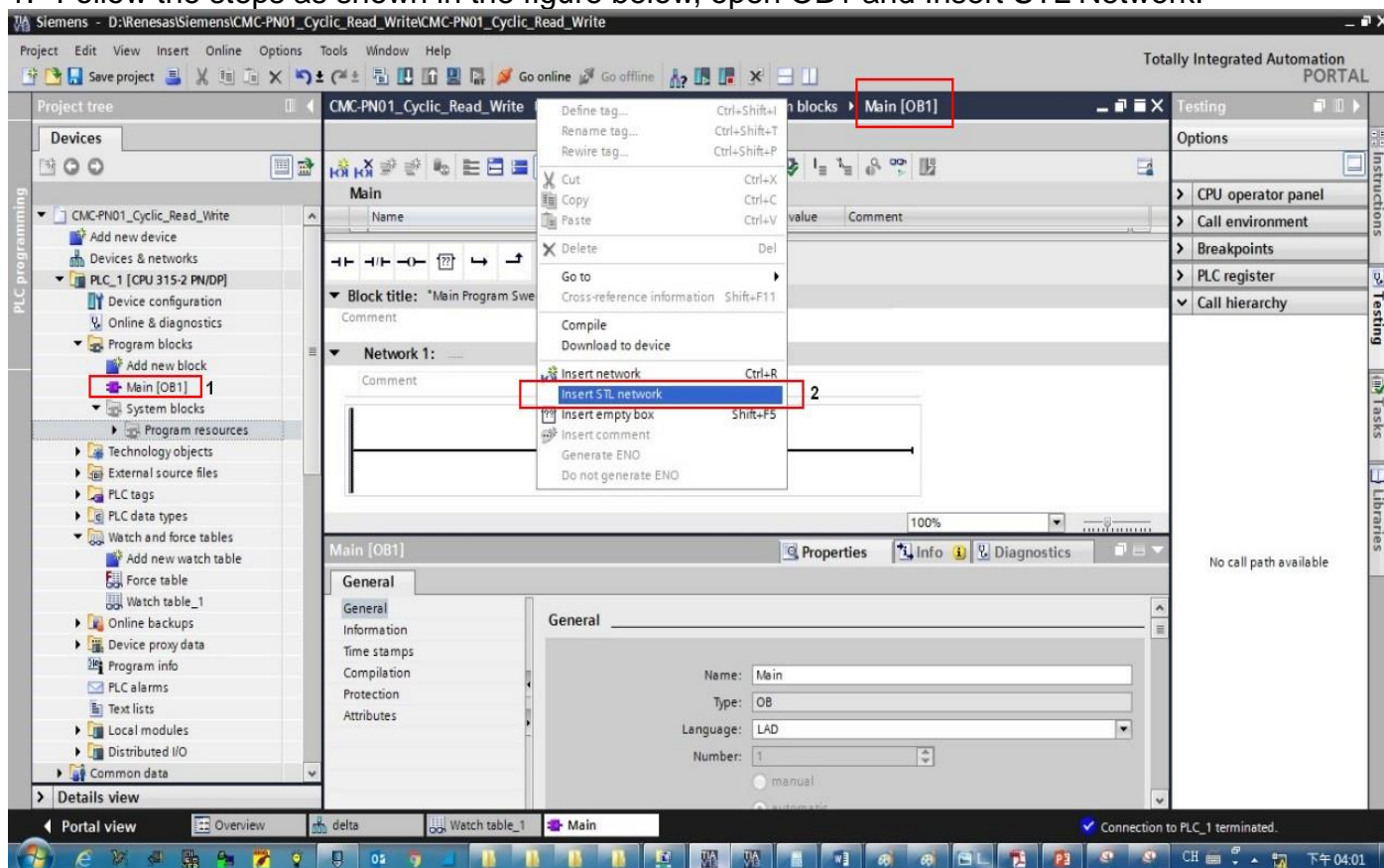

Enter the commands below into STL Network, and then a screen displays as shown in the figure below. Then, click **OK** button.

```
CALL "WRREC" , DB53
REQ :=M41.7
ID :=2042
INDEX :=16#4d2
LEN :=6
DONE :=M41.1
BUSY :=M41.2
ERROR :=M41.3
STATUS:=MD46
RECORD:=P#DB2.DBX 2.0 BYTE 6
```

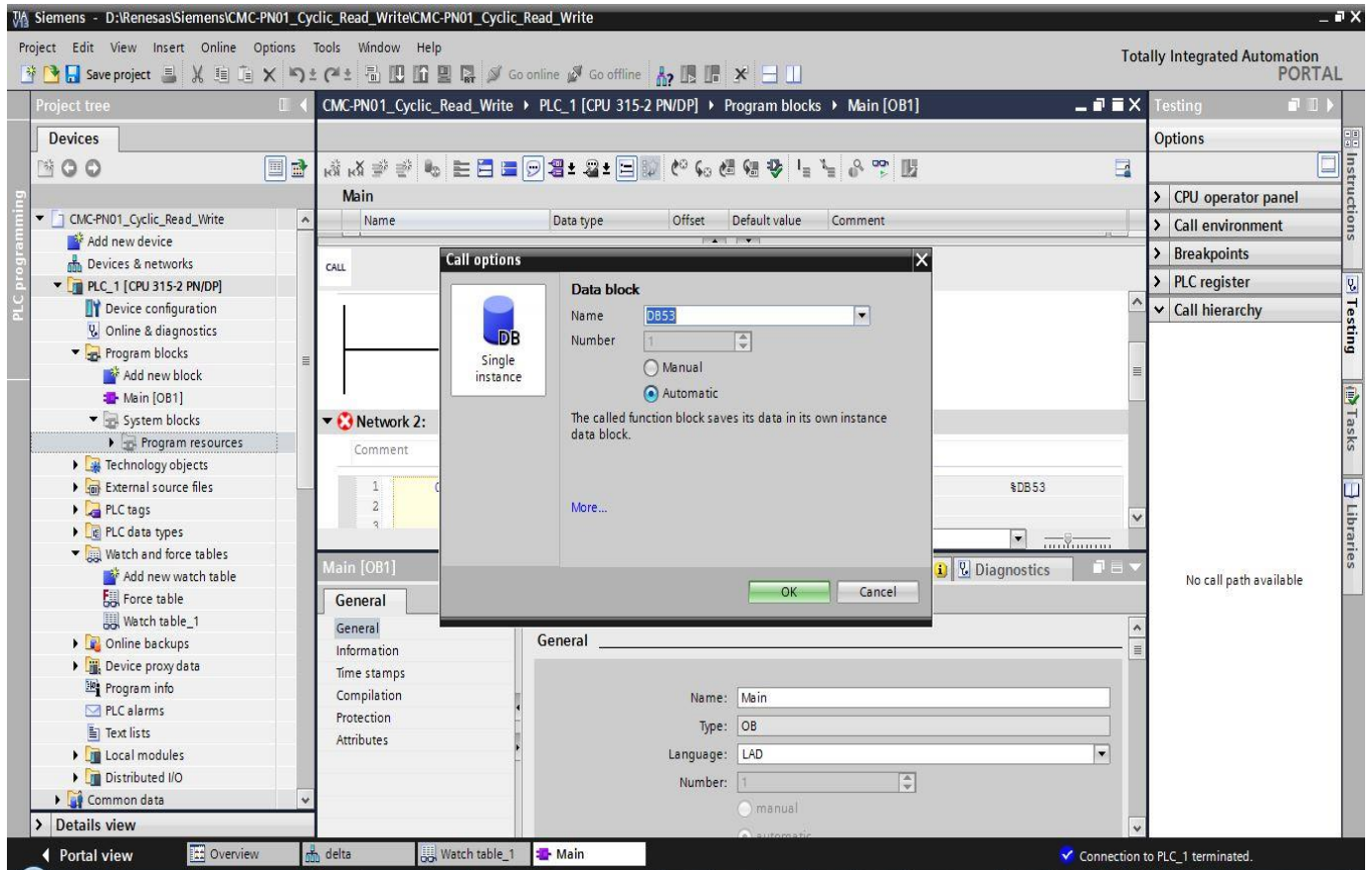

2. Follow the three steps as shown in the figure below to add DB.

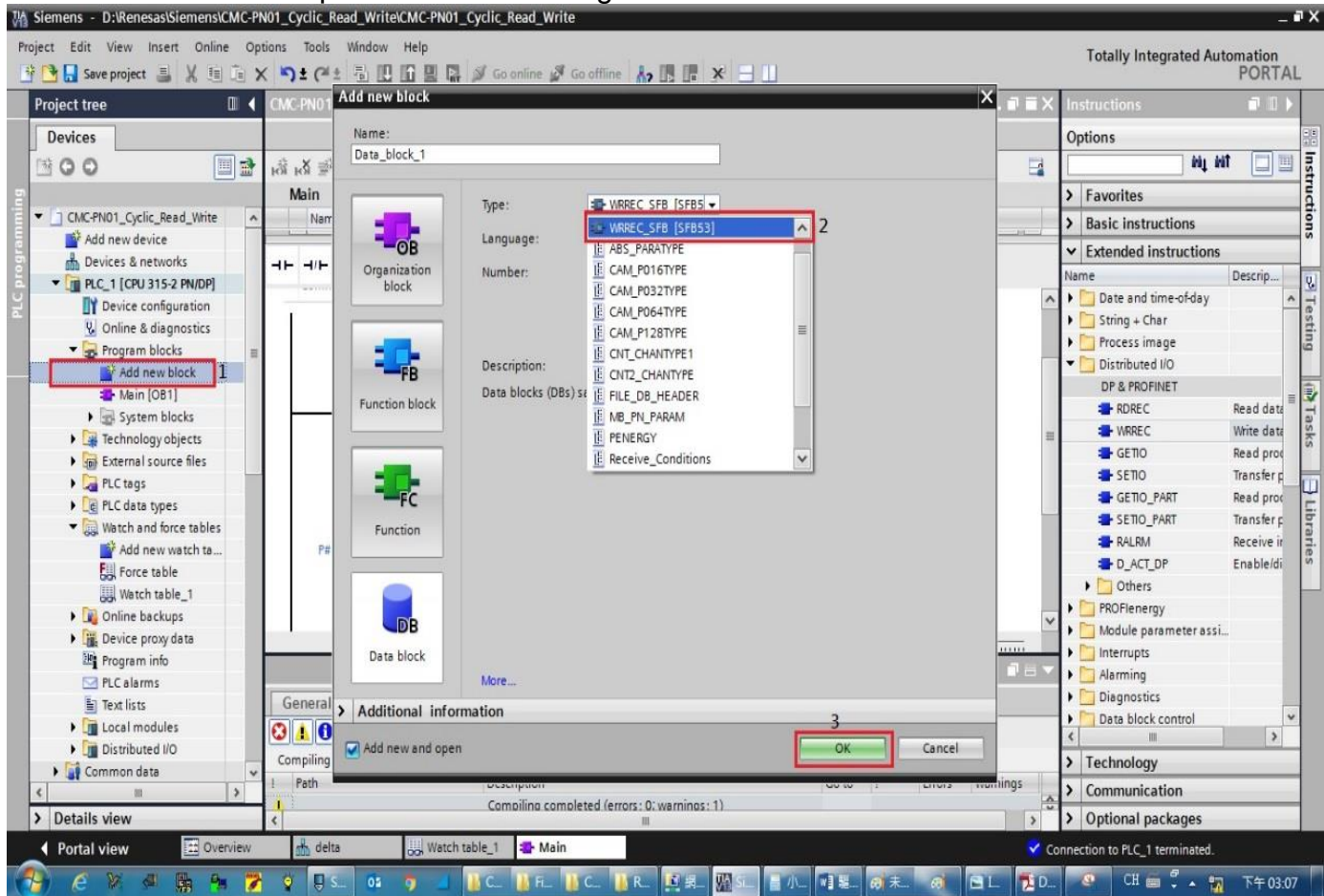



✘ Note: The two DB values in red boxes as shown in the figure below should match.

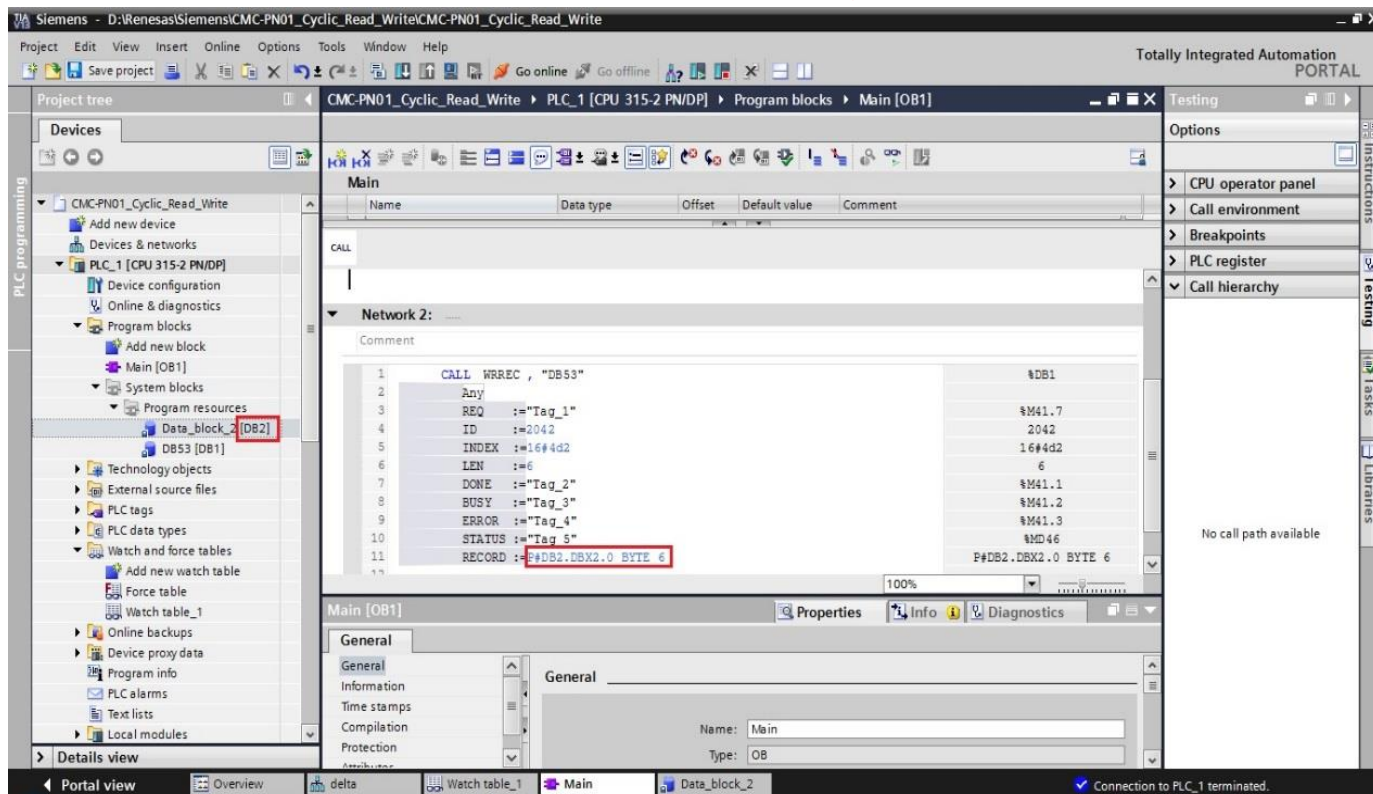

3. Recompile the programs and download them to the PLC program.
4. Test if the programming is workable by using the Watch Table. Refer to the settings in the figure below.

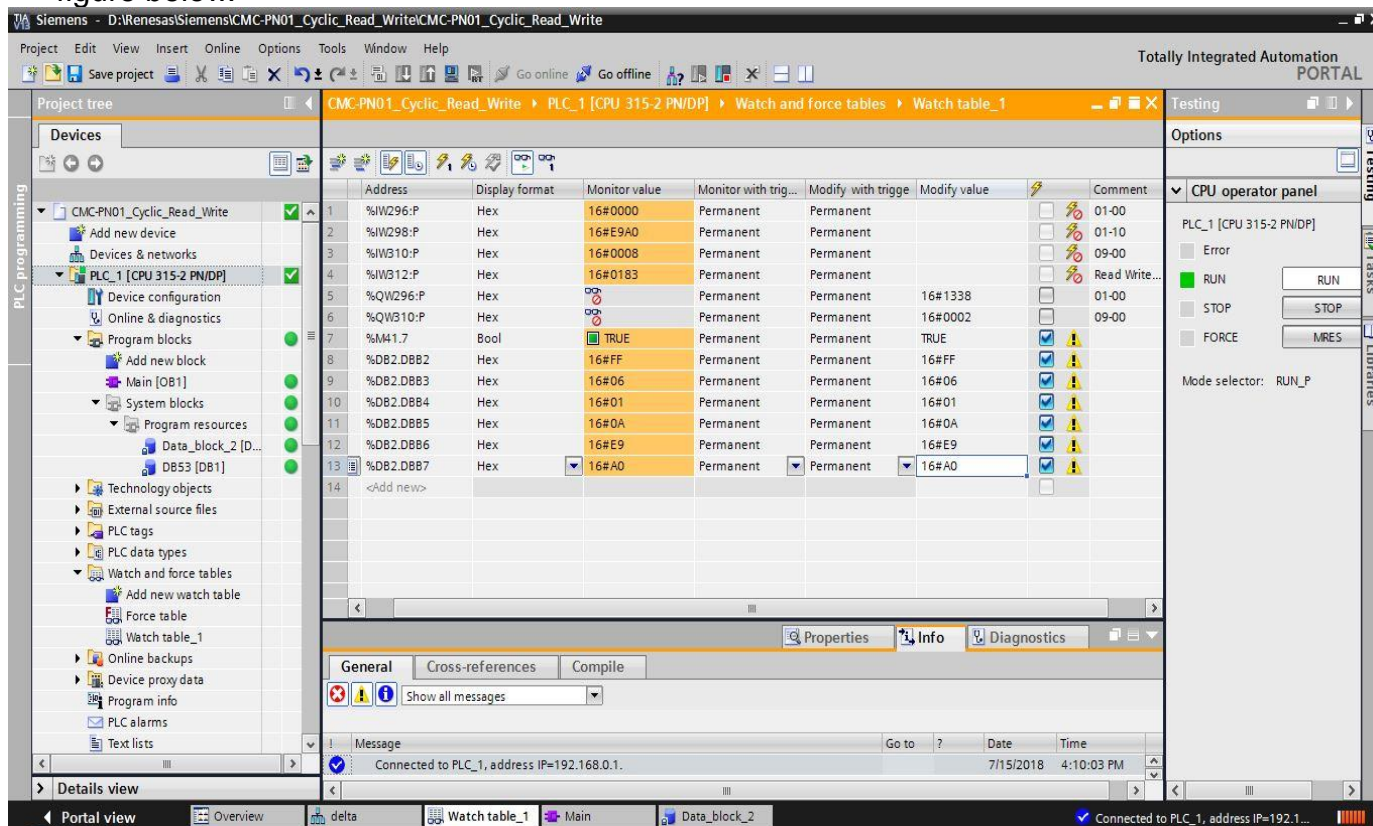

✘ The example of writing the drive parameters above is demonstrated by FF 06 YY YY XX XX. (YY YY indicates the parameter group and parameter number. For example, 01-00 means parameter group 01 and parameter number 00.) (XX XX means the written values. For example, 13 88 = 0x1388.)

✘ You can choose to write the values or not by setting REQ.

Asynchronous reading:

1. Open OB1 and Insert STL Network. Enter the commands below into STL Network, and then a screen displays as shown in the figure below. Then, click **OK** button.

```
CALL "WRREC" , DB53
REQ :=M41.7
ID :=2042
INDEX :=16#4d2
LEN :=4
DONE :=M41.1
BUSY :=M41.2
ERROR :=M41.3
STATUS:=MD46
RECORD:=P#DB4.DBX 2.0 BYTE 4
```

```
CALL "RDREC" , DB52
REQ :=M31.7
ID :=2042
INDEX :=16#4d2
MLEN :=2
VALID :=M31.1
BUSY :=M31.2
ERROR :=M31.3
STATUS:=MD36
LEN :=MW34
RECORD:=P#DB3.DBX 2.0 BYTE 2
```

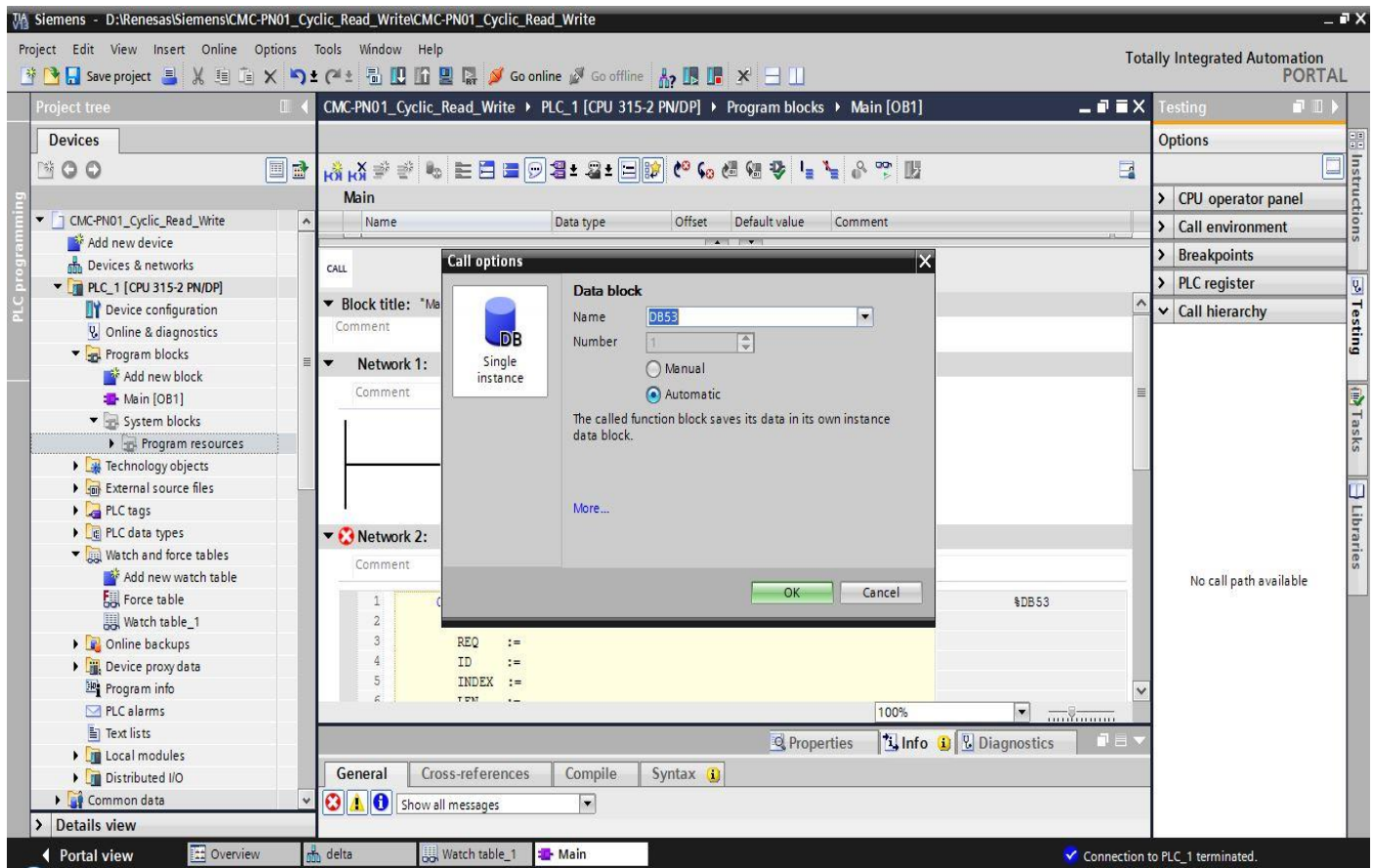



2. After you click **OK** button, a screen displays as shown in the figure below. Note the values in red boxes.

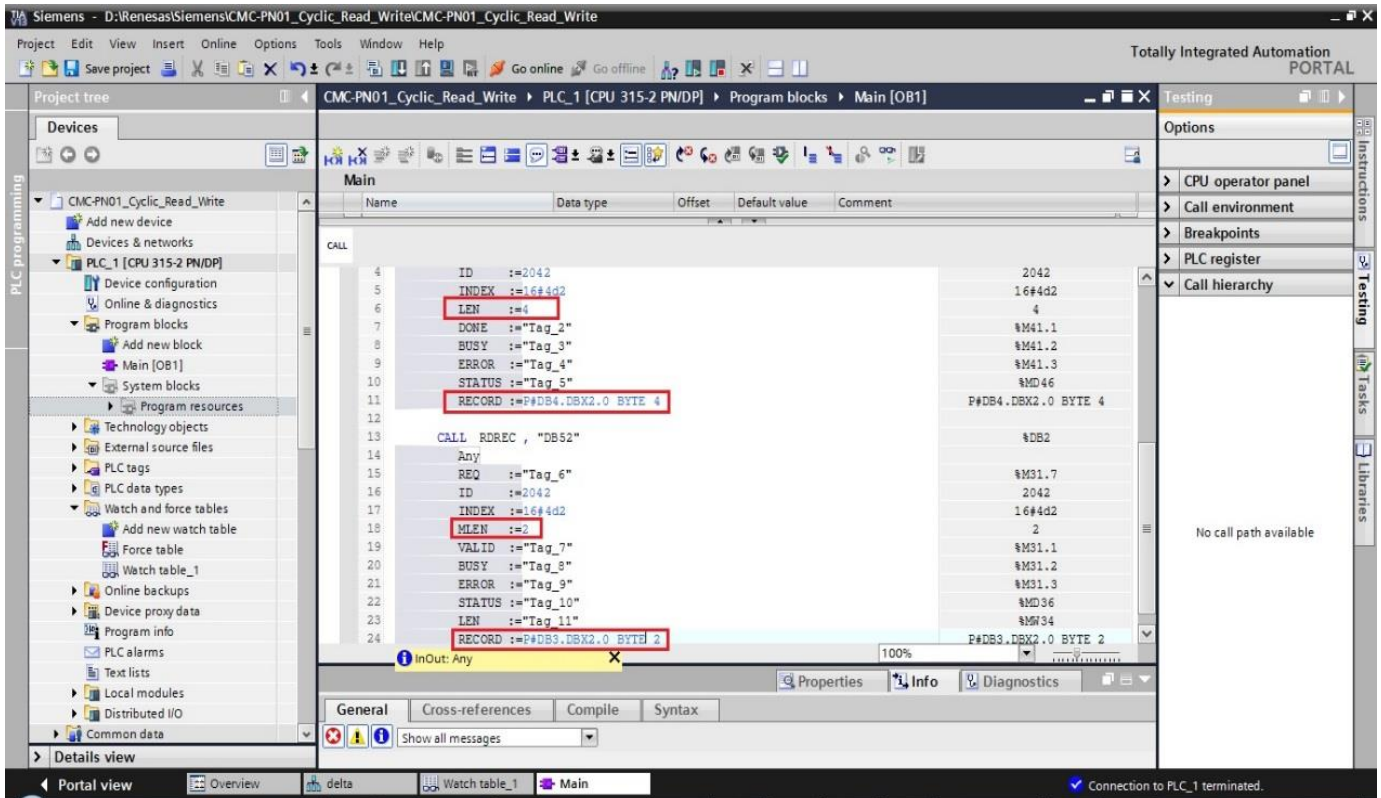

3. Follow the three steps as shown in the figure below to add DB for RDREC and DB for WRREC.

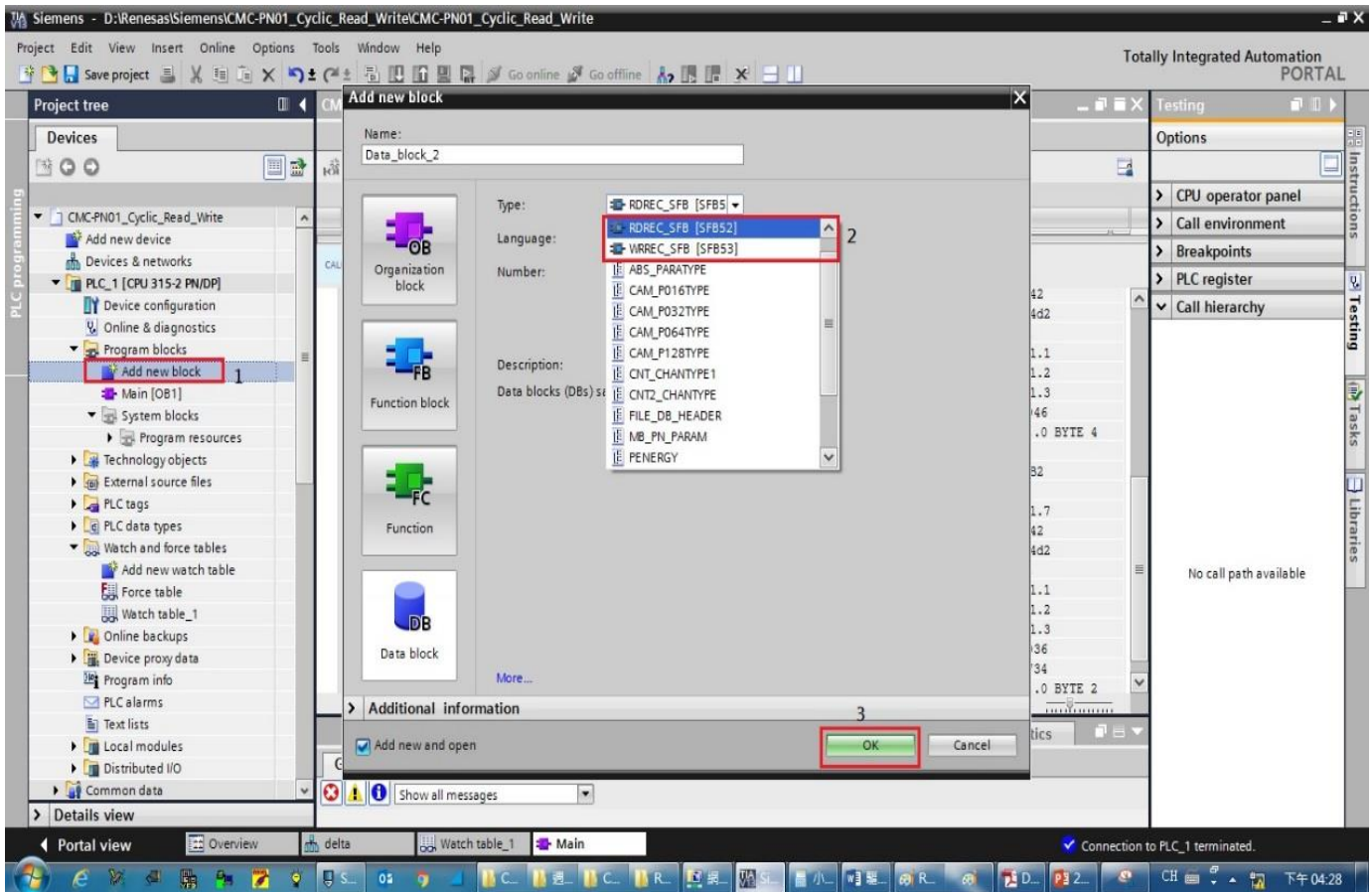

After you finish adding DB, a screen displays as shown in the figure below.

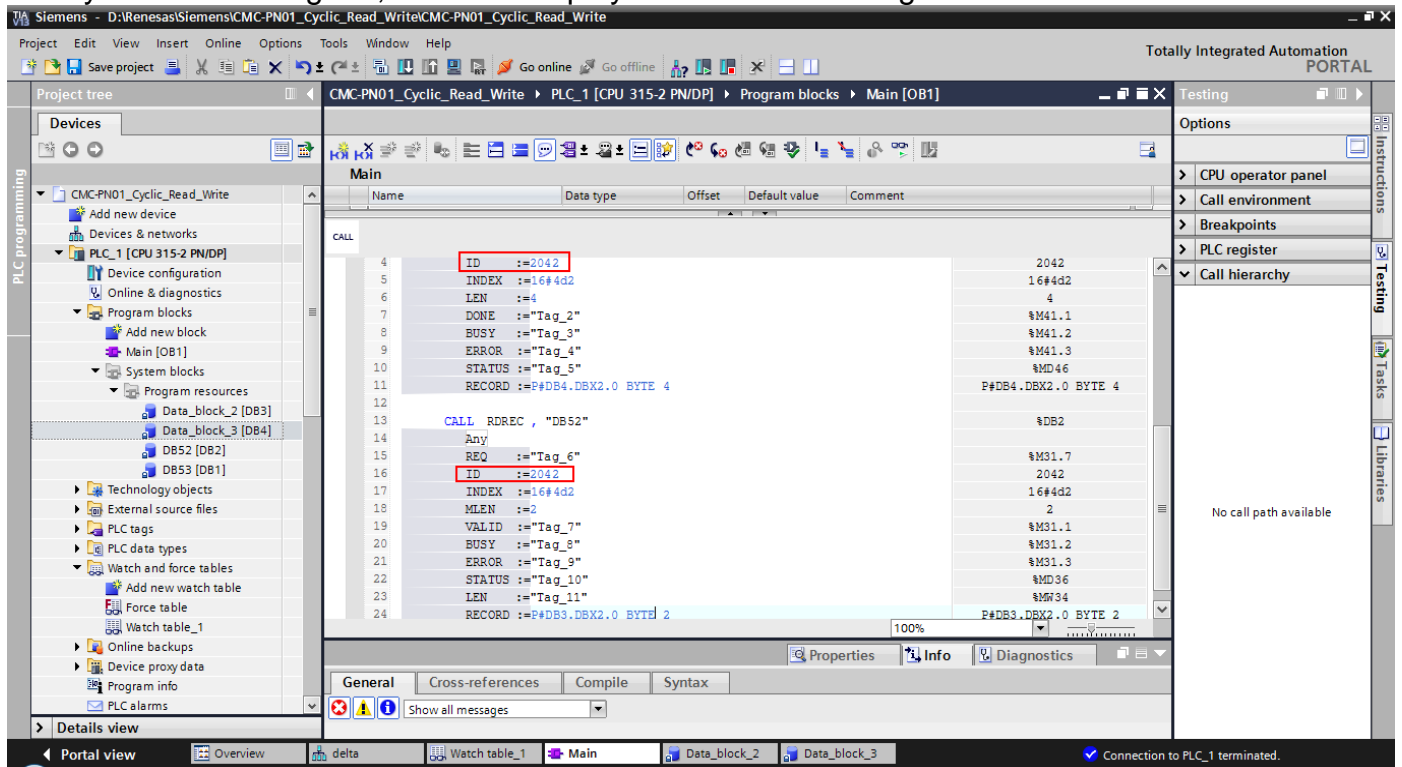

4. Recompile the programs and download them to the PLC program.

5. Test if the programming is workable by using the Watch Table. Refer to the settings in the figure below.

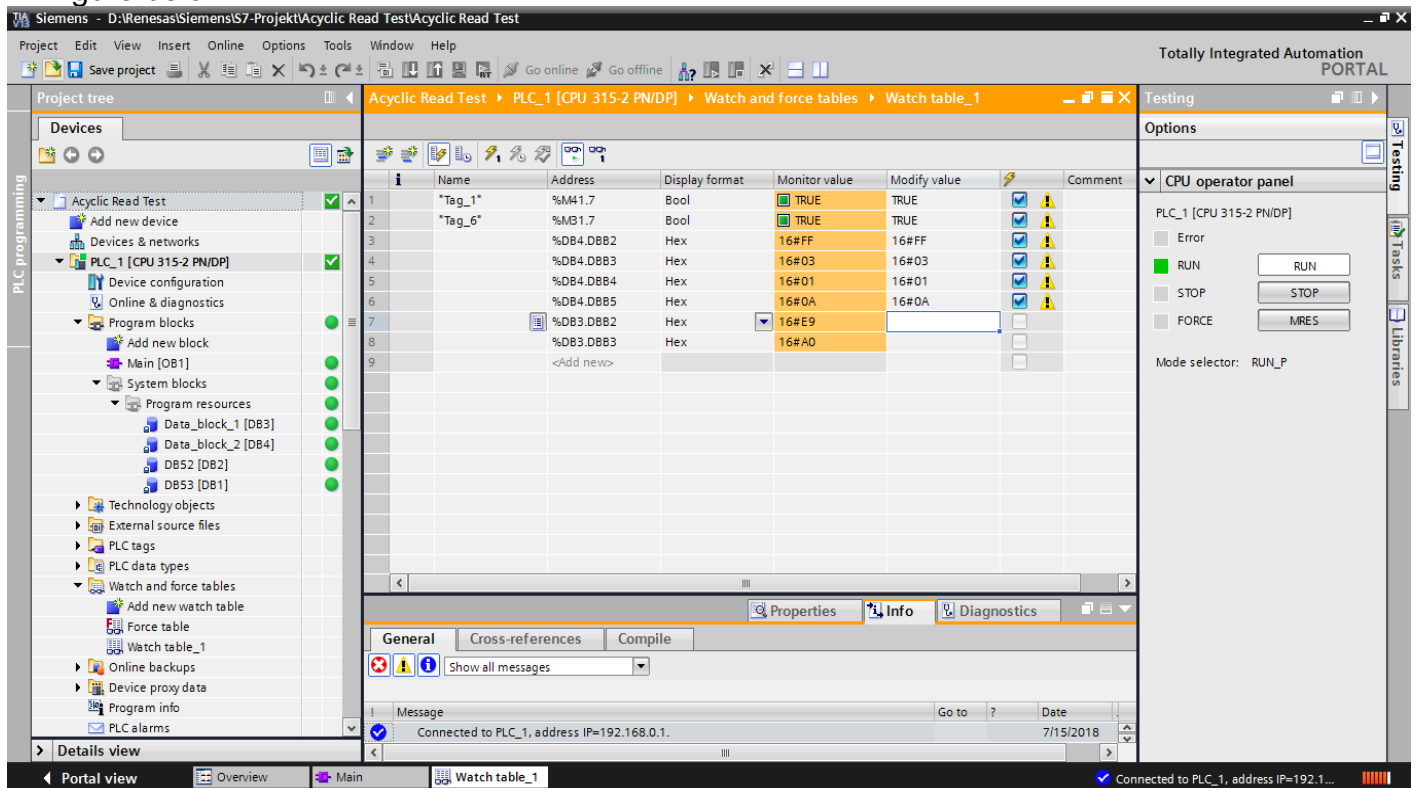

✘ As shown in the example above, before reading the parameters, you must call WRREC functional block to write FF 03 YY YY to change the mode of communication card, and then call RDREC functional block to read the drive parameters (YY YY indicates the parameter group and parameter number. For example, 01-00 means parameter group 01 and parameter number 00.).

✘ You can choose to read the parameters or not by setting REQ.

✘ Note: The ID values in the above-mentioned STL commands can be changed. Refer to the figure below to find the ID setting values.

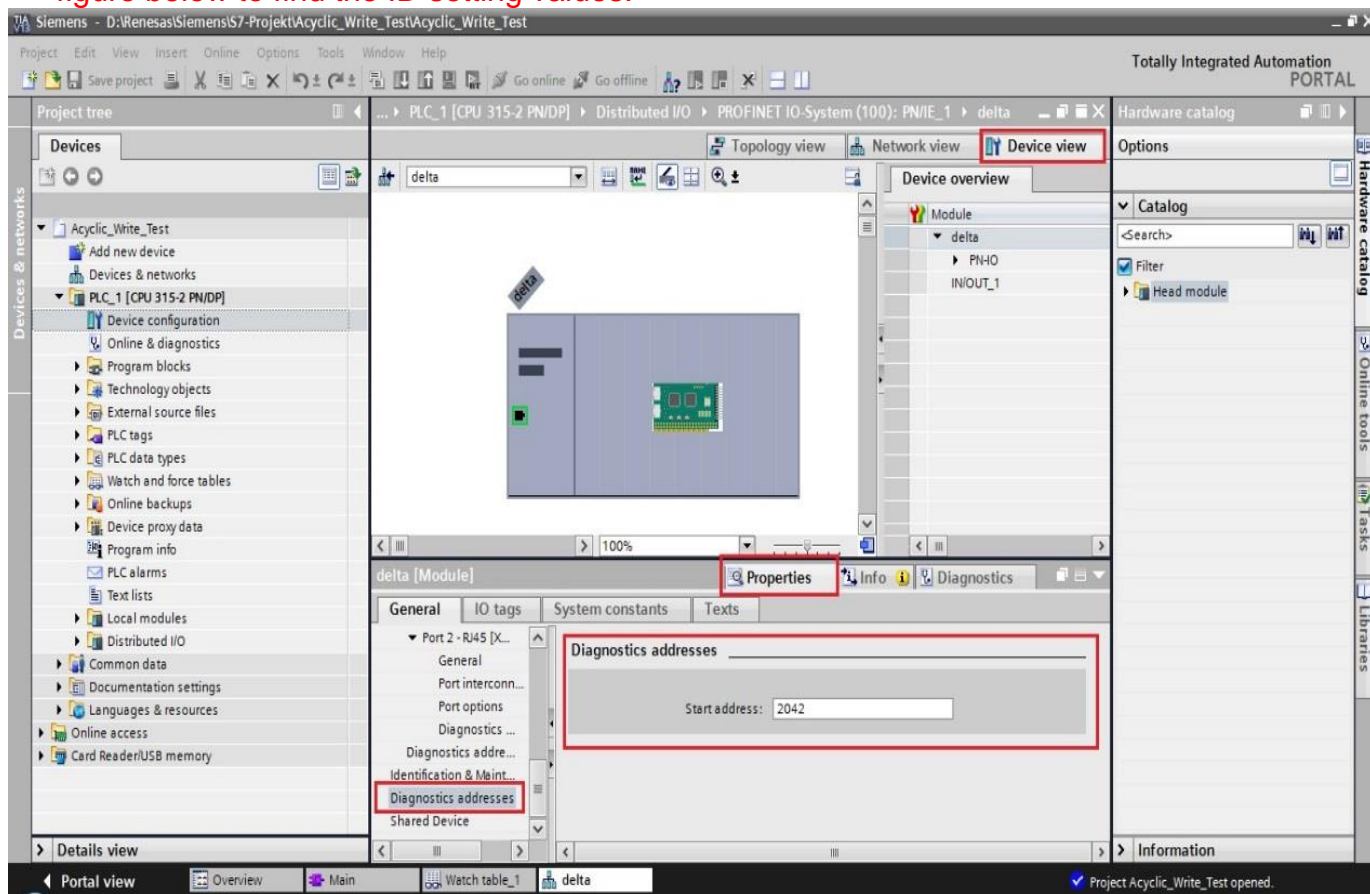

✘ Note: For the PLC program in Siemens 1200 or 1500 Series, refer to the figure below to find the ID setting values in the above-mentioned STL commands.

