



Cordex 220-1.1kW 19" Shelf

For Systems up to 6600W Installation & Operation Manual

Part # 030-718-B2 (Alt. 030-823-B2)
Effective: 03/2013



**Cordex 220-1.1kW
19" Shelf
For Systems up to 6600W**

030-718-B2 (Alt. 030-823-B2)

The following documents and drawings are included in this manual to provide the necessary information required for installation, operation and fault diagnosis of the unit:

- **Specifications, Shelf:** **030-718-B1**
- **Specifications, Rectifier:** **010-569-B1**
- **CSA/NRTL Equivalence:** **048-554-10**
- **Schematic Drawing:** **030-718-05**
- **Outline Drawing:** **030-718-06**
- **Customer Connections:** **030-718-08**

IMPORTANT SAFETY INSTRUCTIONS

SAVE THESE INSTRUCTIONS

1. Please read this manual prior to use to become familiar with the product's numerous features and operating procedures. To obtain a maximum degree of safety, follow the sequences as outlined.
2. This manual provides warnings and special notes for the user:
 - a. Points that are vital to the proper operation of the product or the safety of the operator are indicated by the heading: **WARNING**.
 - b. A notation that is in ***Bold Italic*** typeface covers points that are important to the performance or ease of use of the product.
3. Before using the product, read all instructions and cautionary markings on the product and any equipment connected to the product.
4. Do not expose the product to rain or snow; install only in a clean, dry environment.
5. **CAUTION** – Unless otherwise noted, use of an attachment not recommended or sold by the product manufacturer may result in a risk of fire, electric shock, or injury to persons.
6. **CAUTION** – Do not operate the product if it has received a sharp blow, it has been dropped, or otherwise damaged in any way – return it to a qualified service center for repair.
7. **CAUTION** – Do not disassemble the product – call our qualified service centers for servicing. Incorrect reassembling may result in a risk of electrical shock or fire.
8. **WARNING** – The output voltages of the product are hazardous. Extreme caution should be maintained when servicing or touching conductive components connected to the product's output.

TABLE OF CONTENTS

1	INTRODUCTION	1
1.1	Scope of the Manual	1
1.2	Product Overview	1
1.3	Part Numbers and List Options	1
2	RECTIFIER FEATURES.....	2
2.1	Front Panel.....	2
2.2	Rear Panel	3
2.3	True Module Fail Alarm	3
2.4	Heat Dissipation	3
2.5	Over Temperature Protection	3
2.6	Wide AC Range	4
2.7	AC Inrush/Transient Suppression	4
2.8	Soft Start	4
2.9	Start Delay	4
2.10	Current Limit/Short Circuit Protection	4
2.11	Power Limiting.....	4
2.12	High Voltage Shutdown (HVSD)	4
2.13	Battery Eliminator Operation.....	4
3	INSPECTION.....	5
3.1	Packing Materials	5
3.2	Check for Damage	5
4	INSTALLATION	6
4.1	Safety Precautions	6
4.2	Shelf Preparation/Mounting	6
4.3	Module Insertion/Removal	6
5	WIRING AND CONNECTIONS	7
5.1	Safety Precautions	7
5.2	Tools Required	7
5.3	Power System Chassis Ground	7
5.4	AC Feeder Protection/Sizing.....	7
5.5	AC Input Connections	8
5.6	Calculating Output Wire Size Requirements.....	8
5.7	DC Output Connections	8
5.8	CAN Serial Ports	9
6	OPERATION.....	10
6.1	Main Rectifier States	10
6.2	Main Rectifier Modes	11
6.3	Thermal Management	11
6.4	Factory Ranges and Defaults	12
7	SYSTEM STARTUP	13
7.1	Check System Connections.....	13
7.2	Verify AC and Power the Shelf	13
7.3	Check Battery Polarity and Connect	13
8	MAINTENANCE	14

9	WARRANTY	15
10	ABBREVIATIONS AND ACRONYMS	16

1 Introduction

1.1 Scope of the Manual

This instruction manual explains the installation, interconnection, and operation of Alpha Technologies' Cordex 220-1.1kW 19" shelf for systems up to 6600W.

NOTE: *To aid the user with installation, frequent reference is made to drawings located at the rear of the manual.*

1.2 Product Overview

A complete Cordex rectifier system consists of a controller with one or more power modules in a common shelf enclosure. The shelf has connections for AC inputs, DC output, and system communications.

Cordex rectifier modules use a high frequency, switched mode conversion technique to provide a fully regulated and isolated DC output from the AC mains. The rectifier input is wide range to allow use on 208/220/240 50/60 Hz electrical service. Rectifier power modules are "hot swappable" meaning they can be inserted or removed from the shelf without cutting power to or from the system or the load. Additional power modules can be included with the system at the time of ordering or added after the shelf has been installed.

The shelf rectifier system is designed to operate with the Alpha Cordex system controller (CXC).

There are two external CXC models of the system controller that communicate with the shelf via offset RJ-12 shelf connectors. The CXCR is mounted in a rack and the CXCP is (factory) mounted in a panel.

See manual #018-570-B2.

The CXC allows the user to configure, monitor and control the entire power system and ancillary components from a touch screen display similar to that used in a Personal Digital Assistant (PDA). Other features of the controller include auto equalization, remote access, dial out on alarm, battery diagnostics, as well as Web server and Simple Network Management Protocol (SNMP) support for configuration and monitoring.

Details of controller operation are provided in the current version software manual.

1.3 Part Numbers and List Options

This product is available to order under the following part numbers and list options:

Description	Part Number/List Option
Cordex 220-1.1kW 19" shelf for systems up to 6600W	030-718-20
[equipped to receive up to six CXRC 220-1.1kW rectifiers] (aka 030-823-20).....	*List 0
208/220/240Vac input, dual feeds	List 6
208/220/240Vac input, three feeds	List 9
19" rack, mid-mounting	List 19
Charcoal finish with white (contrasting) silkscreen	*List 56
Rectifier blank plate.....	List 90
Cordex 220-1.1kW rectifier power module.....	010-569-20
Basic module.....	*List 0
Charcoal finish with white (contrasting) silkscreen	*List 56
1x 420Vac and 2x 660Vac MOVs	List 81

* Default option

The above information is valid at the time of publication. Consult factory for up-to-date ordering information.

2 Rectifier Features

2.1 Front Panel



Figure 1–Cordex 220-1.1kW rectifier front panel

2.1.1 LEDs

The front panel LEDs provide rectifier status summary and help to locate a specific module under CXC control.

2.1.1.1 AC

The top LED (green) is on when AC is within valid range. The LED will flash (~2Hz) when AC is outside the nominal range – **AC voltage is invalid if the AC Mains Low or AC Mains High alarm is active**. The LED turns off when AC has failed (or no AC power is present).

2.1.1.2 DC

The middle LED (green) is on when the rectifier is delivering power to the load. The LED will flash when communication is lost. The LED turns off when the rectifier is off; e.g., when commanded via the CXC.

2.1.1.3 ALM (Alarm)

The bottom LED (red) is on continuously in the event of an active Module Fail alarm. The LED will flash (~2Hz) when a minor alarm is detected. The LED remains off in the absence of an alarm. If the unit output is not connected to a battery or parallel rectifier, the LED will extinguish if no AC power is present.

2.1.1.4 LED Activity During Software Upload

When a rectifier software upload is in progress, the LEDs will behave in a distinctly different way to indicate new rectifier software is being transferred from the CXC.

When a rectifier data transfer is in progress, all three LEDs will flash in a sequence lasting 1.5 seconds. When the last LED is lit, the sequence is repeated beginning at the first LED.

2.1.1.5 LED Activity During 'Locate Module' Command from CXC

When the 'locate module' command has been received from the CXC, the LEDs will behave in another distinct fashion so that the rectifier is easier to visually identify among adjacent rectifiers.

This state is entered when commanded via the CXC. The LEDs will flash in a ping-pong pattern repeating every 2 seconds.

The ping-pong pattern lights each LED sequentially. After the last LED is lit, each LED is lit in reverse sequence. When the first LED is lit, the pattern repeats. The effect makes it appear as if the light is bouncing between the first and last LED.

2.1.2 Mechanical

A thumbscrew is provided to secure the rectifier into the shelf. During normal operation the rectifier shall be locked into position. A handle (or grip) is incorporated into the front panel to facilitate the removal of the rectifier from the shelf. No special tools are required.

2.2 Rear Panel

Located on the rear panel of the rectifier is a single connector for shelf power and communications.

2.3 True Module Fail Alarm

The rectifier modules have a "true" fail alarm. This provides a true indication of the module's ability to source current. When the module's output current drops below 2.5% of the rated output a low output current condition is detected and the Module Fail detection circuit is activated. This circuit momentarily ramps up the output voltage to determine if the module will source current. If no increase in current is detected, the Module Fail alarm is activated. The module will test once every 60 seconds for the condition until current is detected. Output voltage ramping will cease upon detection of current¹. A minimum 2.5% load is required to avoid the Ramp Test Fail alarm; this can typically be provided with the parallel system battery. Activation of this alarm could indicate a failed module or a failed load.

NOTE: *For Cordex rectifier systems without batteries (or with a very light load; below 2.5% of rated output) it is recommended that the ramp test be disabled to avoid nuisance alarms. The Ramp Test feature is enabled/disabled via the CXC menu item: Rectifiers, Configure Settings.*

2.4 Heat Dissipation

Heat dissipation of rectifiers is achieved through natural (bottom to top) convection cooling. System exhausts air through side and front vents above rectifiers.

2.5 Over Temperature Protection

Each rectifier module is protected in the event of an excessive increase in temperature due to component failure or cooling airflow blockage. During over temperature conditions, the rectifier limits the output power as well as the output current. **At 65°C output power and current limit are reduced to 70%.** If temperature continues to increase, a shutdown of the rectifier is initiated. The rectifier shall restart automatically if the temperature has returned to a safe level.

¹ Under normal conditions, a battery connected to the output of the rectifier will draw current when the voltage ramp occurs. Therefore the rectifier fail alarm will not be generated with a battery connected.

2.6 Wide AC Range

A minor alarm is generated when the AC input voltage drops below 180Vac. Output power is reduced linearly below 150Vac to 40% of the rated output power. At a lower voltage the rectifier module will shut down and will not restart until the AC is greater than or equal to 150Vac.

For voltages above 276Vac, power factor and total harmonic distortion may be derated. For voltages between 277Vac and 320Vac, the rectifier may not be operational but shall not suffer any damage.

2.7 AC Inrush/Transient Suppression

The inrush current of the rectifier module is limited to less than the nominal peak line current to prevent surge on the AC line. Modules are also protected from input lightning and transient surges in accordance with IEEE/ANSI C62.41 Category B3.

2.8 Soft Start

To eliminate an instantaneous demand on the AC source, a soft start feature is employed. Soft Start, sometimes referred to as “current walk-in”, works by gradually (up to five seconds) ramping the current limit up from zero to the actual or defined customer setting. The rectifier output voltage is ramped up from the minimum voltage to the float voltage.

2.9 Start Delay

The rectifier modules are equipped with a delay timer in order to stagger start a series of modules to prevent excessive loading of generators upon start up. The built-in timer delays the turn on of the module depending on the value selected (up to 120 seconds) via the CXC. A minimum one-second delay is preset to allow charging of the input capacitors.

2.10 Current Limit/Short Circuit Protection

The current limit function determines the maximum output current limit of the rectifier module, regardless of output voltage or power. Maximum output current is limited to a constant value down to short circuit condition. Current limiting can be used to mate the rectifier output current ampacity to the needs of the load and parallel battery to minimize excessive battery recharge current.

The rectifier will sustain a short circuit at the output terminals indefinitely. The maximum short circuit current shall not exceed 105% of the rated full load current.

2.11 Power Limiting

Each rectifier module is designed to limit power output to the module specification. This enables more current to be supplied at lower output voltages, and allows matching of output to the demand of constant power loads, normally seen with telecom equipment.

This feature may also be used for a faster recharge of flooded batteries paralleled with the load.

NOTE: *Current limiting overrides the power-limiting feature.*

2.12 High Voltage Shutdown (HVSD)

This feature provides protection to the load from over voltage conditions originating from the rectifiers. It operates by shutting down the offending rectifier module when a high output voltage condition occurs. Indication is through the red Alarm (Module Fail) LED. Modules will restart automatically; however, if more than three over voltage conditions occur in one minute, the module will latch off and remain shut down until it is reset via the CXC.

2.13 Battery Eliminator Operation

Rectifier modules maintain all specifications (except where indicated) with or without a battery attached in parallel to the output; however, if a battery or another module supplying DC voltage in parallel is not present, there will be no monitoring or control activity if there is an AC power failure or input fuse failure.

3 Inspection

3.1 Packing Materials

All Alpha products are shipped in rugged, double walled boxes and suspended via solid inserts to minimize shock that may occur during transportation. Packaging assemblies and methods are tested to International Safe Transit Association standards.

Products are also packaged with Cortex. This plastic wrap contains a corrosive-inhibitor that protects the product from corrosion for up to two years.

3.1.1 Returns for Service

Save the original shipping container. If the product needs to be returned for service, it should be packaged in its original shipping container. If the original container is unavailable, make sure the product is packed with at least three inches of shock-absorbing material to prevent shipping damage.

NOTE: *Alpha Technologies is not responsible for damage caused by the improper packaging of returned products.*

3.2 Check for Damage

Prior to unpacking the product, note any damage to the shipping container. Unpack the product and inspect the exterior for damage. If any damage is observed contact the carrier immediately.

Continue the inspection for any internal damage. In the unlikely event of internal damage, please inform the carrier and contact Alpha Technologies for advice on the impact of any damage.



Verify that you have all the necessary parts per your order for proper assembly.

4 Installation



WARNING

This system is designed to be installed in a restricted access location that is inaccessible to the general public.

This chapter is provided for qualified personnel to install the product, which shall be mounted in a clean and dry environment.

NOTE: *To aid the user with installation, frequent reference is made to drawings located at the rear of the manual.*

4.1 Safety Precautions



WARNING

Hazardous voltages are present at the input of power systems. The DC output, from the rectifiers, is classified as hazardous voltage and has a high short circuit current capacity that may cause severe burns and electrical arcing.

Before working with any live battery or power system/distribution center, follow these precautions:

- Remove all metallic jewelry; e.g., watches, rings, metal rimmed glasses, necklaces.
- Wear safety glasses with side shields (and prescription lenses if necessary) at all times during installation.

Metallic tools must be insulated.

The installer should follow all applicable local rules and regulations for electrical and battery installations; e.g., CSA, UL, CEC, NEC, OSHA, and local fire codes.

4.2 Shelf Preparation/Mounting

The shelf has been designed for mounting in a standard EIA 19" rack. See drawing 030-718-06.

NOTE: *The shelf shall be mounted in a clean and dry environment. Allow at least 1.75" of free space above and below the unit for unrestricted cooling airflow.*

Mounting brackets accommodate either 1" or 1-3/4" rack spacing. The shelf should be mounted to the rack using at least two #12 – 24 x 1/2" screws in each bracket. Philips-type screws and screwdriver should be used to eliminate the possibility of slippage and scratching of the unit's exterior. Washers (such as internal tooth) or special screws that are designed to cut through the painted surface should be used to ensure a good chassis ground.

4.3 Module Insertion/Removal

Insert by placing the module on the shelf bottom and sliding the module into the rear connector (inside of the shelf). Apply pressure on the module handle to engage the rear connector in the shelf receptacle.

Tighten the screw on the bottom of the faceplate to secure the module to the shelf.

NOTE: *Do not force a module into position if it does not seat properly. All modules are keyed to ensure that the correct module (polarity/voltage) type is used.*

To remove a module, loosen the screw on the bottom of the faceplate. Grasp handle and pull out, sliding the module away from the rear connector and out of the shelf.

5 Wiring and Connections

This chapter provides cabling details and notes on cable sizing for DC applications with respect to the shelf.

NOTE: Refer also to foldout drawings located at the rear of the manual.

5.1 Safety Precautions



WARNING

Hazardous AC voltages may be present. Ensure power at the AC service panel is off before attempting work on the AC connections. Use a voltmeter to verify the absence of voltage. Clearly mark the correct polarity of the battery leads before commencing work on DC connections.

Refer to the previous (Installation) chapter for additional safety precautions.

5.2 Tools Required

Various tools are essential for product installation. Use this list as a guide:

- Slot head screwdrivers (blade sizes: 1/4", 1/8", 1/16")
- Philips head screwdriver, #2 (tip size 3/16")
- Digital voltmeter equipped with test leads
- Adjustable 220Vdc load (optional)
- Cutters and wire strippers
- Crimping tool (optional for large gauge wire)
- Socket and ratchet set (Imperial measure).

5.3 Power System Chassis Ground



WARNING

For safety reasons, ensure the system is properly bonded to the building's ground grid. 220Vdc systems are typically floating; i.e., not connected to earth ground.

Connect the chassis ground to the site ground to ensure correct operation of the CXC and to prevent drifting floating analog (especially current) readings. The Ground Fault Detect circuit will not function properly if the chassis is not connected to the site ground.

5.4 AC Feeder Protection/Sizing

To maximize system reliability, a dual AC feed divides the rectifiers into two groups to be supplied by two separate feeds. A three feed option divides the rectifiers into three groups to be supplied by three separate feeds.

It is recommended to use a dedicated protection feeder breaker, located at the AC distribution panel, to act as the disconnect device for the connected modules.

Number of Rectifiers on AC Feed	Circuit Breaker Exact Value to Use (A)	90 deg. C Wire Gauge to use at 30 deg. C ambient (AWG)
1	15	12
2	20	12
3	30	10

Table A—Recommended AC supply configuration

5.5 AC Input Connections

CAUTION: AC input wires should be routed in flexible or rigid conduit as far away as possible from the DC power wires to minimize EMI disturbances.

Remove the metal cover from the rear of the shelf to expose the wireway for the input terminal blocks.

The wireway is designed for two customer-supplied 1" conduit fittings for AC supply located on the left side of the shelf and two 3/4" conduit fittings on the rear.

Attach the conduit retainers to the wireway hole(s) and route the AC cables through. Secure the wires to the AC input and chassis ground terminals as required. Tighten the cable connector to the AC cable (conduit similar).

Replace rear cover once all connections have been completed.

5.6 Calculating Output Wire Size Requirements

Wire size is calculated by first determining the appropriate maximum voltage drop requirement. Using the formula below calculate the CMA wire size requirement. Determine the size and number of conductors required to satisfy the CMA requirement.

$CMA = (A \times LF \times K) / AVD$, where:

CMA =	Cross section of wire in circular MIL area
A =	Ultimate drain in amps
LF =	Conductor loop feet
K =	11.1 constant factor for commercial (TW type) copper wire
AVD =	Allowable voltage drop

Check again that the ampacity rating of the cable meets the requirement for the installation application. Consult local electrical codes (NEC, CEC, etc.) for guidelines. If required, increase the size of the cable to meet the code.

5.7 DC Output Connections



WARNING

Leave cables or bus bars disconnected at battery and verify output polarity using a voltmeter. Make battery connections only after all other wiring is completed.

DC output wire shall be UL approved XHHW or RHH/RHW (for Canadian users, RW90 Type). Control and sense wires shall be UL approved Style 1015 (for Canadian users, TEW type).

Connect DC output cables at the side of the shelf and terminate cable leads with appropriate crimp lugs.

Route output cables through the side of the shelf and secure the positive and negative to the shelf output post of the correct polarity; i.e., +V_{cab} to +V_{post}. Ensure the washers are on the bolts in the same order in which they were shipped from the factory. Tighten the bolts as per Customer Connections drawing at the rear of this manual.

Replace rear cover once all connections have been completed.

5.8 CAN Serial Ports

Connect Cordex equipment and set jumpers as shown:



Serial ports, for communications with Alpha's Cordex rectifiers and other CAN-enabled equipment, are located on the backplane.

Daisy-chain from shelf to shelf as necessary and ensure that the last shelf is terminated with the jumper (below).

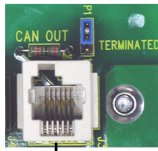

System equipped with CXCP or CXCR has one CAN OUT port.

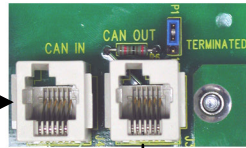

List 81
Shelf equipped for six rectifiers
has one CAN IN port and one
CAN OUT port.

The jumper (P1) allows setting of
the CAN OUT to be open to next
shelf or TERMINATED if last shelf
on CAN bus, as shown here:

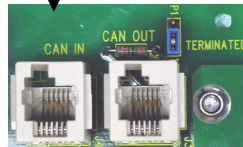

Figure 2–CAN ports for multiple shelf connections with CXCR

6 Operation

6.1 Main Rectifier States

Rectifier operation can be broken up into five main states:

1. Off,
2. Start delay,
3. Soft start,
4. Normal operation,
5. Turning off.

Each state is characterized as being distinct and necessary for the operation of the rectifier. These states are briefly described below.

6.1.1 Off State

The rectifier will be in the Off state immediately after power is applied to the rectifier or after a rectifier shutdown. The shutdown source may be remote or local shutdown, AC shutdown, OVP or thermal shutdown.

When the rectifier is in this state the DC-DC converter is turned off and the CXC will be monitoring its inputs for the proper conditions to begin the start up sequence.

When the conditions have been met for the rectifier to start up, it will transition to the Start Delay state.

6.1.2 Start Delay State

When the rectifier is in the Start Delay state, the DC-DC converter is held off and still not sourcing power and is waiting for a given amount of time before transitioning to the next state.

When in this state, the CXC continues to monitor its inputs.

After the Start Delay state the rectifier will transition to the Soft Start state.

NOTE: *Soft start, or current walk-in, gradually increases the voltage and current output of the rectifier upon startup. This is done to reduce the instantaneous load on the AC source.*

6.1.3 Soft Start State

When the Soft Start state is entered, the rectifier will be turned on and the output voltage and output current will be gradually increased. If a load is present, the rectifier will begin to source power.

When the voltage and current limit ramps have finished, the rectifier will transition to the Normal Operation state.

6.1.4 Normal Operation State

The Normal Operation state is the state that the rectifier will be in performing all of the rectifier functions and features specified herein.

From this state, the only valid transition is to the Turning Off state. This transition will happen if the rectifier is required to shutdown.

6.1.5 Turning Off State

The Turning Off state is entered because a short delay is required before the rectifier actually turns off to take care of any initialization requirements.

When this short delay has elapsed, a transition to the Off state is made.

6.2 Main Rectifier Modes

In addition to Main Rectifier States, there is a set of Main Rectifier Modes. These modes can be divided into two categories as follows:

6.2.1 Output Voltage Modes

Voltage modes can be thought of as modes that, under software control, can directly adjust the output voltage. The qualification of ‘under software control’ is made because there are processes that occur in the rectifier that can change the output voltage that do not adjust the output voltage directly (such as the rectifier being in current limit).

The following table lists the five Output Voltage Modes and a description of when they are active:

Output Voltage Modes	Active when...
Float	Output voltage is set to the float voltage setting.
Equalize	Output voltage is set to the equalize voltage setting.
Battery Test	Output voltage is set to the battery test voltage setting.
Safe	Output voltage is set to the safe mode voltage setting.
Manual Test	Output voltage can be manually adjusted outside of the standard adjustment ranges.

Table B–Output voltage modes

6.2.2 Output Current/Power Modes

These modes directly affect the output current and power.

The following table lists the four Output Current/Power Modes and a description of when they are active:

Output Current/Power Mode	Active when...
Temperature foldback mode	Output current and power limit have been reduced due to high temperature of the heatsink or internal ambient temperature sensor.
AC foldback mode	Output current and power limit have been reduced due to low AC input voltage. <i>Note: this will reduce the risk of tripping an AC breaker due to increased AC current draw as the AC voltage decreases.</i>
Short circuit foldback mode	Output current limit has been reduced due to a short circuit at the output.
Internal fault foldback mode	Output current limit has been reduced due to an internal fault.

Table C–Output current/power modes

6.3 Thermal Management

Heat dissipation of rectifiers is achieved through natural (bottom to top) convection cooling. Performance of the rectifiers can vary depending on the ambient temperature and whether the convection path of the exhaust air through the enclosure is hindered. A rectifier’s specified performance may also be affected by adjacent rectifiers in the shelf.

Even with one or more Over-temperature and Current Limit alarms active, the shelf is typically able to supply the demanded power steadily. For example, the shelf can deliver 95% load at 45°C, with some alarms active. However in higher ambient temperatures, load reduction may be necessary.



6.4 Factory Ranges and Defaults

The following table lists the rectifier settings/ranges/defaults; changes are made via the CXC:

Setting	Range (minimum to maximum)	Default
Float (FL) Voltage	180 – 320V	229.5V
Equalize (EQ) Voltage	180 – 320V	239.7V
Battery Test (BT) Voltage	180 – 320V	195.5V
Safe Mode Voltage	180 – 320V	218.5V
OVP	See note below – 325V	253V
Current Limit (CL)	9 – 100%	100%
Power Limit (PL)	0 – 100%	100%
Module Start Delay	0 – 250s	1s
System Start Delay	0 – 600s	0s
Low Voltage Alarm (LVA)	180 – 320V	187V
High Voltage Alarm (HVA)	180 – 320V	244.8V
EQ Timeout	1 – 2399h	30h
BT Timeout	1 – 250h	8h
Softstart Ramp-rate	Normal/Fast	Normal
CL/PL Alarm	Enable/Disable	Enable
Remote Shutdown	Enable/Disable	Enable
Ramp Test	Enable/Disable	Enable

Table D–Cordex 220-1100W factory ranges and defaults

NOTE: OVP cannot be set below the present system/FL/EQ/BT voltage setting or the safe mode voltage of 218.5V.

7 System Startup

After completing the shelf wiring and installation, perform the following startup and test procedure to ensure proper operation:

7.1 Check System Connections

- Ensure AC is off, battery is disconnected, and all power modules are removed from the shelf.
- Triple check the polarity of all connections.

7.2 Verify AC and Power the Shelf

- Install one power module.
- Verify AC input voltage is correct and turn on the corresponding AC input feeder breaker.
- The power module OK LED should illuminate after a preset start delay.
- Using the CXC, test functionality of various module alarms and controls.

7.3 Check Battery Polarity and Connect

- Verify correct battery polarity using a voltmeter (ensuring no cells or batteries are reversed).
- Connect battery as required to the output of the system or turn on battery breaker.
- Install remaining power modules.
- In the adjustments menu of the CXC (web browser), set Float and Equalize voltage to the levels specified by the battery manufacturer.
- Using the CXC, test functionality of various module alarms and controls. In addition, perform a load test with the system using a resistive load box as needed.

8 Maintenance

Although very little maintenance is required with Alpha systems, routine checks and adjustments are recommended to ensure optimum system performance. Qualified service personnel should do repairs.

The following table lists a few maintenance procedures for this system. These procedures should be performed at least once a year.



WARNING: HIGH VOLTAGE AND SHOCK HAZARD.

Use extreme care when working inside the shelf while the system is energized. Do not make contact with live components or parts.

Circuit cards, including RAM chips, can be damaged by static electricity. Always wear a grounded wrist strap when handling or installing circuit cards.

Procedure	Date Completed
Clean ventilation openings	
Inspect all system connections (re-torque as necessary)	
Verify alarm/control settings	
Verify alarm relay operation	

Table E–Sample maintenance log

NOTE: *There are no field replaceable parts.*

9 Warranty

Alpha Technologies Ltd warrants all equipment manufactured by it to be free from defects in parts and labor, for a period of two years from the date of shipment from the factory. The warranty provides for repairing, replacing or issuing credit (at Alpha's discretion) for any equipment manufactured by it and returned by the customer to the factory or other authorized location during the warranty period. There are limitations to this warranty coverage. The warranty does not provide to the customer or other parties any remedies other than the above. It does not provide coverage for any loss of profits, loss of use, costs for removal or installation of defective equipment, damages or consequential damages based upon equipment failure during or after the warranty period. No other obligations are expressed or implied. Warranty also does not cover damage or equipment failure due to cause(s) external to the unit including, but not limited to, environmental conditions, water damage, power surges or any other external influence.

The customer is responsible for all shipping and handling charges. Where products are covered under warranty Alpha will pay the cost of shipping the repaired or replacement unit back to the customer.

Visit <http://www.alpha.ca> for full warranty information.

10 Abbreviations and Acronyms

AC	Alternating current
ANSI	American National Standards Institute
AWG	American wire gauge
BTU	British thermal unit
CAN	Controller area network
CEC	Canadian Electrical Code
CSA	Canadian Standards Association
CX	Cordex™ series; e.g., CXC for <u>C</u> ordex <u>S</u> ystem <u>C</u> ontroller
DC	Direct current
EIA	Electronic Industries Alliance
EMC	Electromagnetic compatibility
EMI	Electromagnetic interference
ERM	<u>E</u> lectromagnetic compatibility and <u>r</u> adio spectrum <u>m</u> atters
ESD	<u>E</u> lectro <u>s</u> tatic <u>d</u> ischarge
FCC	Federal Communications Commission (for the USA)
HVSD	<u>H</u> igh <u>v</u> oltage <u>s</u> hutdown
IEC	International Electrotechnical Commission
IEEE	Institute of Electrical and Electronics Engineers
LCD	Liquid crystal display
LED	Light emitting diode
LVD	Low voltage disconnect
MTBF	Mean time between failures
NC	Normally closed
NEC	National Electrical Code (for the USA)
NO	Normally open
OSHA	Occupational Safety & Health Administration
OVP	Over voltage protection
RAM	Random access memory
RU	Rack unit (1.75")
TCP/IP	Transmission control protocol / internet protocol
THD	Total harmonic distortion
UL	Underwriters Laboratories

CSA/NRTL — MARKS — BACKGROUND

What are the CSA and NRTL?

CSA (Canadian Standards Association also known as CSA International) was established in 1919 as an independent testing laboratory in Canada. CSA received its recognition as an NRTL (Nationally Recognized Testing Laboratory) in 1992 from OSHA (Occupational Safety and Health Administration) in the United States of America (Docket No. NRTL-2-92). This was expanded and renewed in 1997, 1999, and 2001. The specific notifications were posted on OSHA's official website as follows:

- Federal Register #: 59:40602 - 40609 [08/09/1994]
- Federal Register #: 64:60240 - 60241 [11/04/1999]
- Federal Register #: 66:35271 - 35278 [07/03/2001]

When these marks appear with the indicator "C and US" or "NRTL/C" it means that the product is certified for both the US and Canadian markets, to the applicable US and Canadian standards. (1)

Alpha rectifier and power system products, bearing the aforementioned CSA marks, are certified to CSA C22.2 No. 60950 and UL 60950.

Alpha UPS products, bearing the aforementioned CSA marks, are certified to CSA C22.2 No.107.3 and UL 1778.

As part of the reciprocal, US/Canada agreement regarding testing laboratories, the Standards Council of Canada (Canada's national accreditation body) granted Underwriters Laboratories (UL) authority to certify products for sale in Canada. (2)

Only Underwriters Laboratories may grant a licence for the use of this mark, which indicates compliance with both Canadian and US requirements. (3)

What are NRTLs and what do they do?

NRTLs are third party organizations recognized by OSHA, US Department of Labor, under the NRTL program.

The testing and certifications are based on product safety standards developed by US based standards developing organizations and are often issued by the American National Standards Institute (ANSI). (4)

The NRTL determines that a product meets the requirements of an appropriate consensus-based product safety standard either by successfully testing the product itself, or by verifying that a contract laboratory has done so, and the NRTL certifies that the product meets the requirements of the product safety standard. (4)

When was the NRTL started and who governs it?

In 1983, in a suit brought on by an independent testing laboratory, OSHA was court ordered to remove specific references to UL (Underwriters Laboratories) and FMRC (Factory Mutual Research Corporation) from its regulations.

In 1988, OSHA revised its regulations to remove those references and the NRTL program was established.

The NRTL Program is both national and international in scope with foreign labs permitted.

References:

Information in this document has been developed from the official websites of the respective organizations.

- (1) www.csa-international.org
- (2) www.scc.ca
- (3) www.ulc.ca
- (4) www.osha.gov



The product on which either of these marks appear has been certified by CSA as meeting applicable Canada/US standards.



The product on which this mark appears has been certified by UL as meeting applicable Canada/US standards.

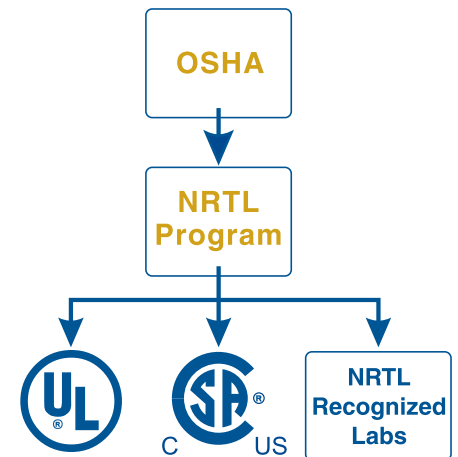

Specifications for Alpha's Cordex 220-1100W 19" Shelf For Systems Up To 6600W

Basic Unit, Shelf

Maximum Output Current: 33A @200V

Maximum Output Voltage: 320Vdc

Mechanical

Dimensions: 177mm H x 445mm W x 303mm D (rectifier front panel 19mm D)
[6.98" H x 17.5" W x 11.9" D (rectifier front panel 0.74" D)]

Mounting: 19" rack, flush or midmount

Weight: 7.3 kg (16 lb.)

Connections

AC Input (options): Terminal blocks for two feeds (three modules per), or
Terminal blocks for three feeds (two modules per);
4 to 6mm² (#12 to #10AWG)

Chassis Ground: #1/4-20

Communications: CAN (bus) out RJ-12 offset

DC Output: #1/4-20 on 5/8" centers

Safety

CSA: C22.2 No. 60950-1-07

UL: 60950-1: 2007

CE: Low Voltage Directive 2006/95/EC; EMC Directive 2004/108/EC, CB Scheme

IEC/EN: 60950-1:2006

The above information is valid at the time of publication. Consult factory for up-to-date ordering information. Specifications are subject to change without notice.

Specifications for Alpha's Switched Mode Rectifier Cordex 220-1.1kW

Power Module Output

Voltage:	180 to 320Vdc within rated limits
Current:	5A @ 220Vdc nominal (5.5A maximum)
Maximum Power:	1100W continuous/module
Static Load Regulation:	Better than $\pm 0.5\%$ for any load change within rated limits
Dynamic Load Regulation:	Better than $\pm 2\%$ for 10% - 90% load step
Static Line Regulation:	Better than $\pm 0.1\%$ for any change in input voltage within rated limits
Dynamic Line Regulation:	Better than $\pm 1\%$ for any change in input voltage within rated limits
Hold-up Time:	>10ms
Time Stability:	$\leq 0.2\%$ per year
Temperature Stability:	$\leq 100\text{ppm}/^\circ\text{C}$ over the operating range
Heat Dissipation:	<300BTU per hour
Electrical Noise:	<10mVrms to 100MHz (wideband) <80mVp-p to 100MHz
Acoustic Noise:	<55dBa @ 1m (3ft.) @ 30°C (86°F) [individual module] <55dBa @ 1m (3ft.) @ 30°C (86°F) [four modules]
EMI:	The unit meets requirements of EN55022 (see Standards for more EMC)
Insulation:	2.5kVac input-earth, 3kVac input-output, 2kVac output-earth, 0.5kVac signals-earth

In accordance with FCC requirements, we provide the following statement as specified in the FCC guidelines for conformance to Part 15, Class A:

NOTE: *This equipment has been tested and found to comply with the limits for a Class A digital device, pursuant to part 15 of the FCC Rules. These limits are designed to provide reasonable protection against harmful interference when the equipment is operated in a commercial environment. This equipment generates, uses, and can radiate radio frequency energy and, if not installed and used in accordance with the instruction manual, may cause harmful interference to radio communications. Operation of this equipment in a residential area is likely to cause harmful interference in which case the user will be required to correct the interference at his own expense.*

Any changes or modifications to this equipment not expressly described in this manual could void the FCC compliance.

Specifications for Alpha's Switched Mode Rectifier Cordex 220-1.1kW Continued

Power Module Input

Voltage:	208 to 240Vac nominal
Extended Operation:	Low: 176 to 150Vac (power de-rated linearly to 75% output) High: 176 to 320Vac (de-rated power factor above 265Vac)
Frequency:	50/60Hz nominal (45 to 66Hz)
Current:	5.8 to 5A (nominal Vac) 6.9A maximum @176Vac
Power Factor:	>0.99 at nominal conditions and 50-100% load; >0.98 at nominal conditions and 30-100% load
Protection:	10kA-interrupting capacity fuses in active and neutral lines
Efficiency:	>93% at nominal conditions and 50-100% load
Inrush Current:	≤ full load steady state current of the rectifier within rated limits
Start-up Ready Time:	<5 seconds (excluding soft start) to complete inrush limit routine and ac measurement (for OK signal)
Start-up Delay:	Programmable up to 120 seconds to enable stagger-start of multiple rectifiers and to minimize the effect on a supply source
Soft Start:	User adjustable to at least 5 seconds (not including start-up delay time) and is determined by output current limit ramp-up
T.H.D. (Current):	<5% at 100% load
Input Transient Suppression:	Meets ANSI/IEEE C62.41 Category B3
Input Leakage Current:	<3.5mA @ 265Vac 60Hz

Miscellaneous

MTBF:	>400,000 hours
Dimensions:	177mm H x 71mm W x 250mm D (excluding connector) [6.9" H x 2.8" W x 9.8" D]
Weight:	2.9 kg (6.4 lb.)

Environmental

Temperature Operating:	-40 to +50°C (-40 to 122°F)
Extended:	600W @ +65°C (149°F)
Storage:	-50 to +85°C (-58 to 185°F)
Humidity:	0 to 95% non-condensing
Elevation:	-500 to +4000m; derate @ -4°C/1000m above sea level (-1640 feet to 13124 feet; derate @ -7.2°F/3281 feet above sea level)

Specifications for Alpha's Switched Mode Rectifier Cordex 220-1.1kW Continued

Referenced Standards

EN 300 386-2	EMC and ERM; Telecommunication Network Equipment
EN 55022 (CISPR 22): 1998	Information Technology Equipment – Radio Disturbance Characteristics – Limits and Methods of Measurement
EN 61000-3-2:2000	Harmonic Current Emissions
EN 61000-3-3:1995	Voltage Fluctuations and Flicker
EN 61000-4-2	ESD Immunity
EN 61000-4-3	Radiated Electromagnetic Immunity
EN 61000-4-4	Electrical Fast Transient/Burst Immunity
EN 61000-4-5	Power Line Surge Immunity
EN 61000-4-6	Conducted Electromagnetic Immunity
EN 61000-4-11	Voltage Dips, Short Interruptions and Variations
ETS 300 019-1-1	Environmental Conditions; Storage
ETS 300 019-1-2	Environmental Conditions; Transportation
ETS 300 132-2	Power Supply Interface at the Input to Telecommunications Equipment; Operated by Direct Current (DC)
ETS 300 753	Acoustic Noise Emissions
IEC 60950	Safety of Information Technology Equipment, Including Electrical Business Equipment (UL/CSA 60950)

The above information is valid at the time of publication. Consult factory for up-to-date ordering information. Specifications are subject to change without notice.

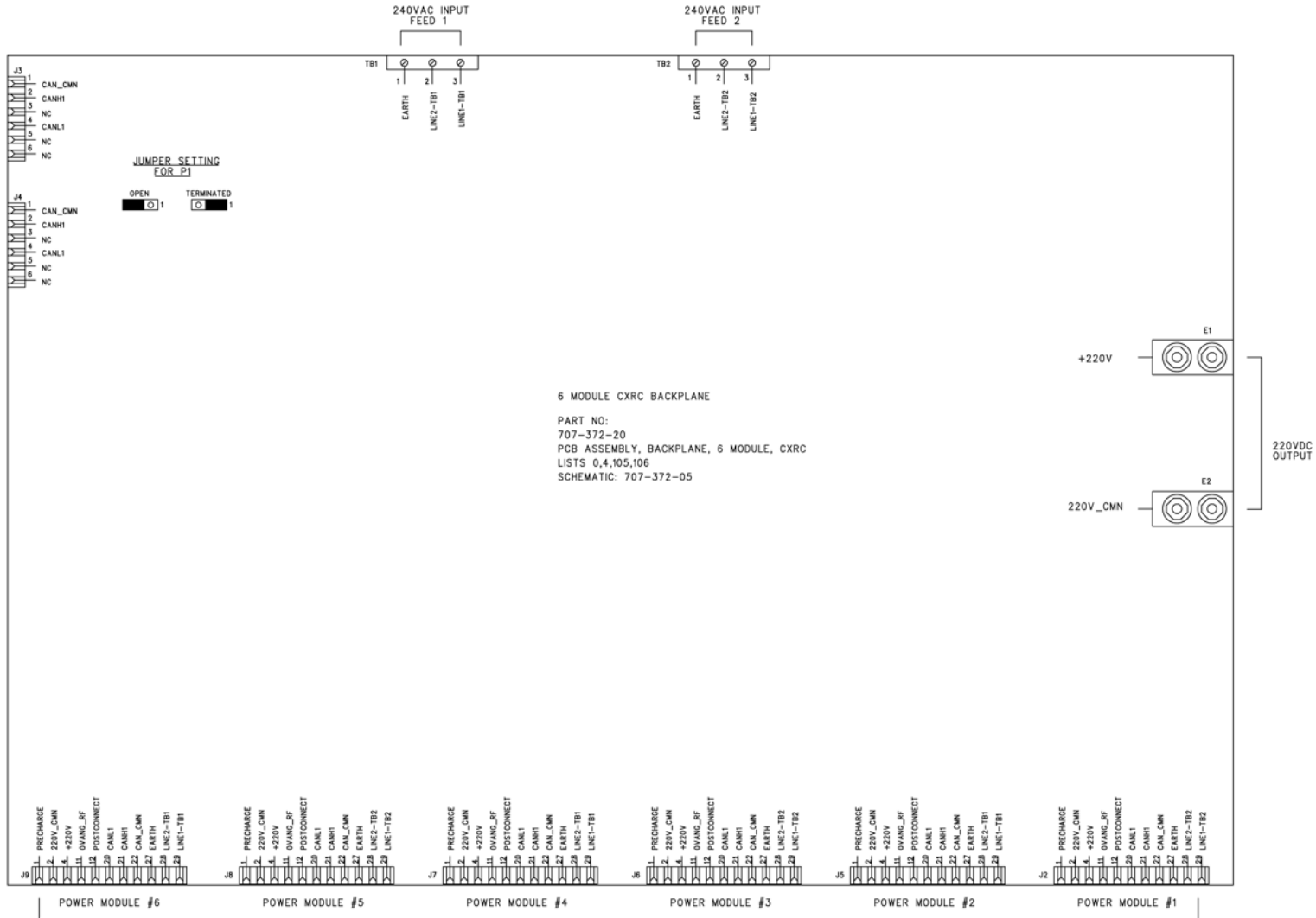

220-1.1kW CXRC POWER MODULE INTERFACE

LISTS SHOWN: 0,6

ARGUS
TECHNOLOGIES

THESE DESIGNS AND SPECIFICATIONS ARE THE PROPERTY OF ARGUS TECHNOLOGIES AND SHALL NOT BE COPIED OR USED FOR MANUFACTURING WITHOUT ITS WRITTEN CONSENT.

DESIGN	WH	2004/08	MATERIAL
DRAWN	JL	2004/08	
CHECKED			
APPROVED			FINISH
TOLERANCES		SCALE	N/A

TITLE: SCHEMATIC, SHELF, 19", 6 MDL, 220-1.1kW CXRC

ISSUE DATE		SHEET 1 of 2
SIZE	DWG NO. 030-718-05	REV A

REVISION			
LTR	DESCRIPTION	DATE	APPD

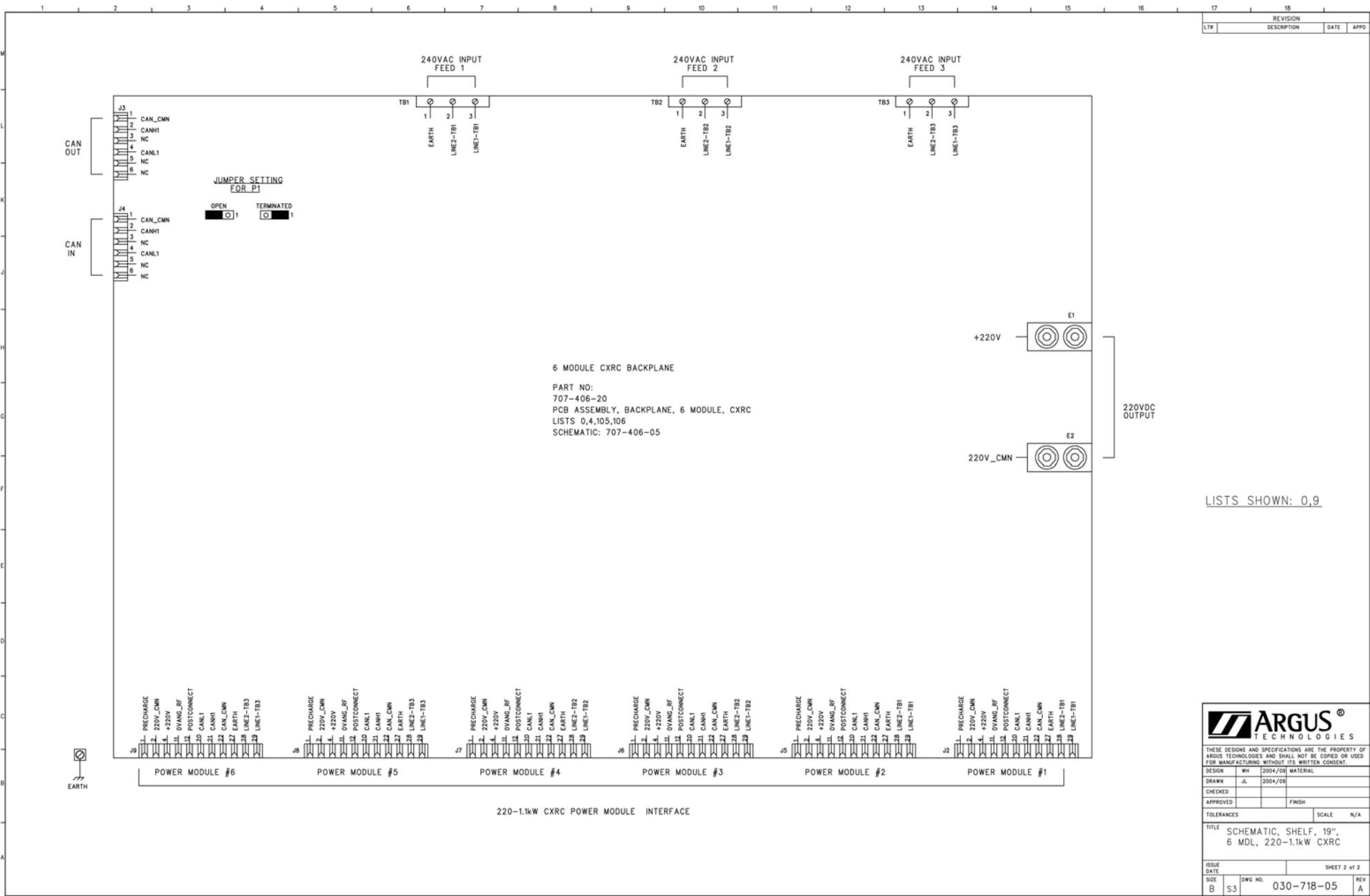

LISTS SHOWN: 0,9

ARGUS
TECHNOLOGIES

THESE DESIGNS AND SPECIFICATIONS ARE THE PROPERTY OF ARGUS TECHNOLOGIES AND SHALL NOT BE COPIED OR USED FOR MANUFACTURING WITHOUT ITS WRITTEN CONSENT.

DESIGN	WH	2004/09	MATERIAL
DRAWN	JL	2004/09	
CHECKED			
APPROVED			FINISH
TOLERANCES			SCALE N/A

TITLE: SCHEMATIC, SHELF, 19", 6 MDL, 220-1.1kW CXRC

ISSUE DATE		SHEET 2 of 2
SIZE	B 3.3	DWG No. 030-718-05
		REV A

REVISIONS				
LTR	DESCRIPTION	REV BY	DATE	APPD

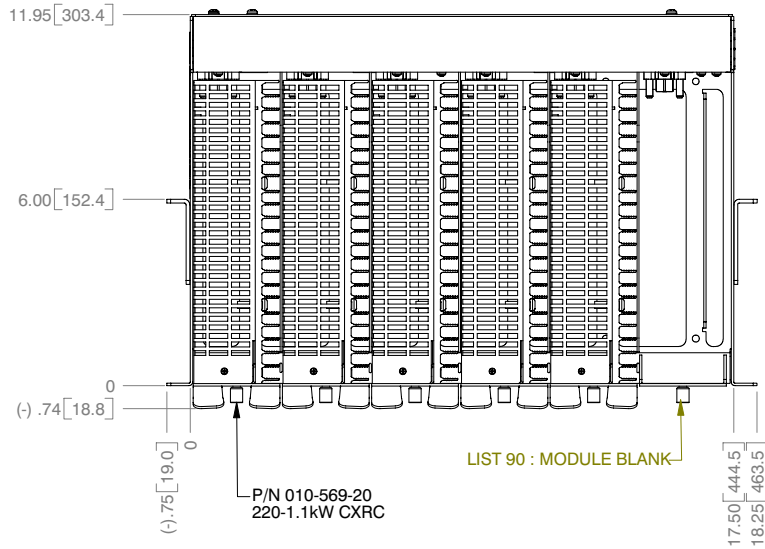

TOP VIEW

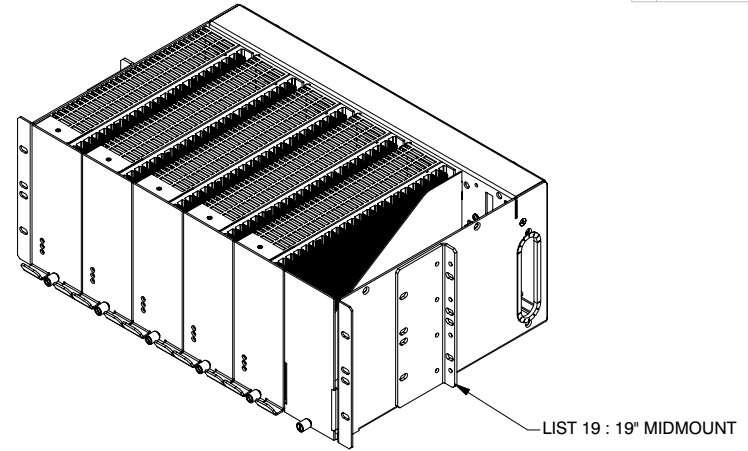

FRONT ISOMETRIC VIEW

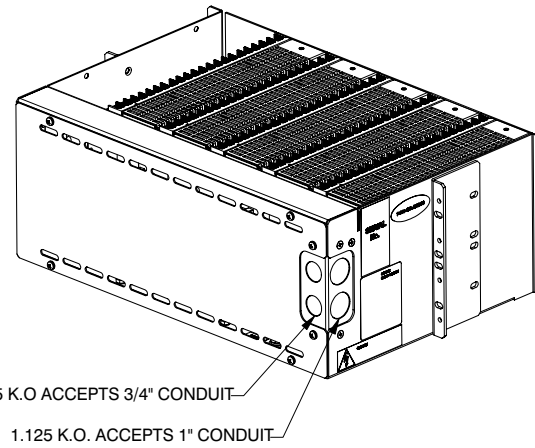

REAR ISOMETRIC VIEW

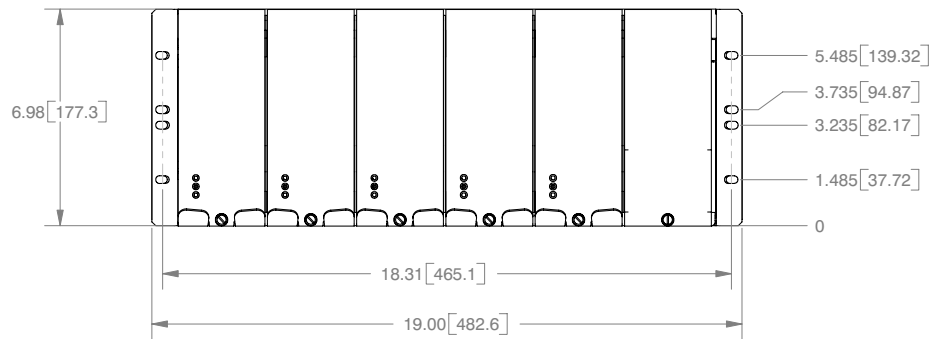

PLAN VIEW

© 2003 ARGUS TECHNOLOGIES

DIMENSIONS ARE IN INCHES WITH METRIC [mm] IN BRACKETS: INCHES [mm]

ARGUS[®]

THESE DESIGNS AND SPECIFICATIONS ARE THE PROPERTY OF ARGUS TECHNOLOGIES AND SHALL NOT BE COPIED OR USED FOR MANUFACTURING WITHOUT ITS WRITTEN CONSENT.

DESIGN	DWG	2004/12	MATERIAL
DRAWN	DGW	2004/12	
CHECKED	---		
APPROVED	---		FINISH
TOLERANCES			PER P.O. and Doc. 070-024-83
XX	±0.04"	[X]	±1mm
XXX	±0.02"	[X]	±0.5mm
XXXX	±0.01"	[X]	±0.25mm
TITLE			SCALE
OUTLINE, 19 FLUSH MOUNT CABINET			NTS
6 MDL, 220-1.1kW CXRC			
ISSUE	DATE		SHEET
			1 OF 1
SIZE	TYPE	DWG NO.	REV
B	D2	030-718-06	A

REVISIONS				
LTR	DESCRIPTION	REV BY	DATE	APPD
B	UPDATED AC I/P TERM. BLOCK FROM LINE2 TO L2/N	SDW		

LIST 0,6 : 6 MODULE (DUAL FEED)

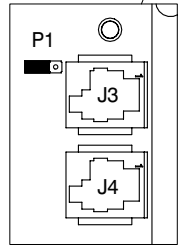
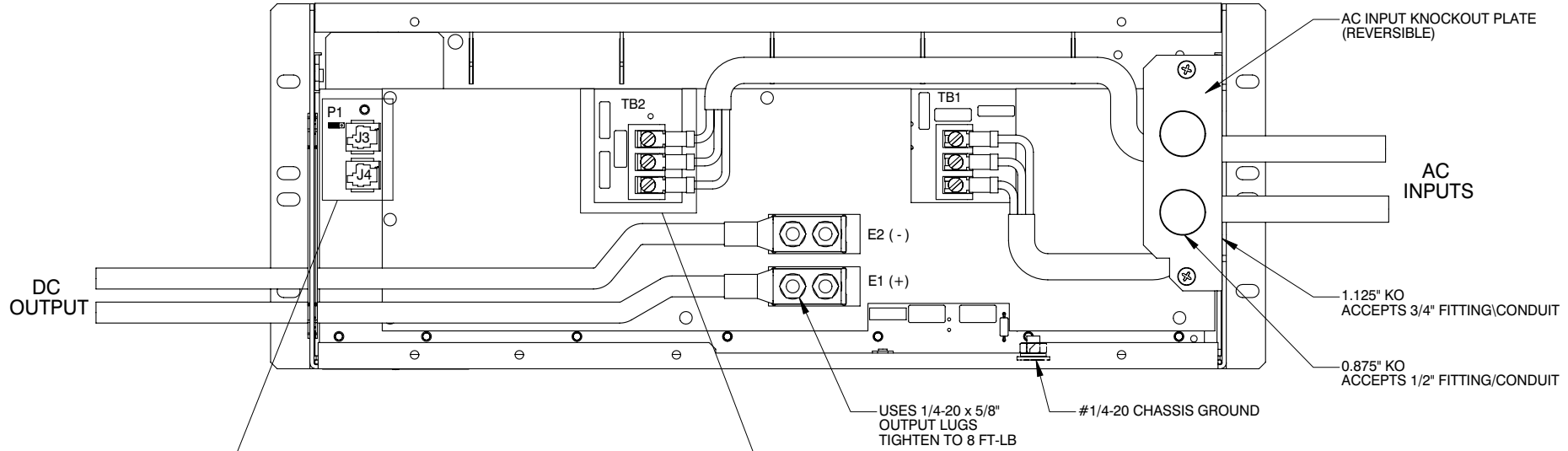

JUMPER SETTING FOR P1

- CAN TERMINATED
- CAN UNTERMINATED

CAN OUT RJ12 OFFSET PIN OUT (J3) **CAN IN RJ12 OFFSET PIN OUT (J4)**

- | | |
|------------------|------------------|
| 1. GND | 1. GND |
| 2. CAN H | 2. CAN H |
| 3. NOT CONNECTED | 3. NOT CONNECTED |
| 4. CAN L | 4. CAN L |
| 5. NOT CONNECTED | 5. NOT CONNECTED |
| 6. NOT CONNECTED | 6. NOT CONNECTED |

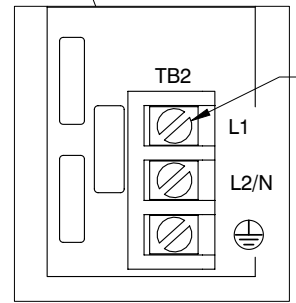

TYPICAL AC INPUT TERMINAL BLOCK (TB2 SHOWN)

TB1 FEEDS RECTIFIERS 2,4,6
TB2 FEEDS RECTIFIERS 1,3,5

ARGUS®

THESE DESIGNS AND SPECIFICATIONS ARE THE PROPERTY OF ARGUS TECHNOLOGIES AND SHALL NOT BE COPIED OR USED FOR MANUFACTURING WITHOUT ITS WRITTEN CONSENT.

DESIGN	DGW	200405	MATERIAL
DRAWN	DGW	200405	SEE B.O.M. 030-718-20
CHECKED	JK	2004/12	
APPROVED	CDD	2004/12	FINISH

TOLERANCES
 XX ±0.04" [X] ±1mm
 XXX ±0.02" [XX] ±0.5mm
 XXXX ±0.01" [XXX] ±0.25mm

TITLE: **CUSTOMER CONNECTION, 6 MODULE, 220-1.1kW**

SCALE: NTS

LIST 0,9 - 6 MODULE (3 FEEDS)

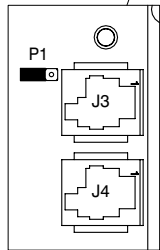
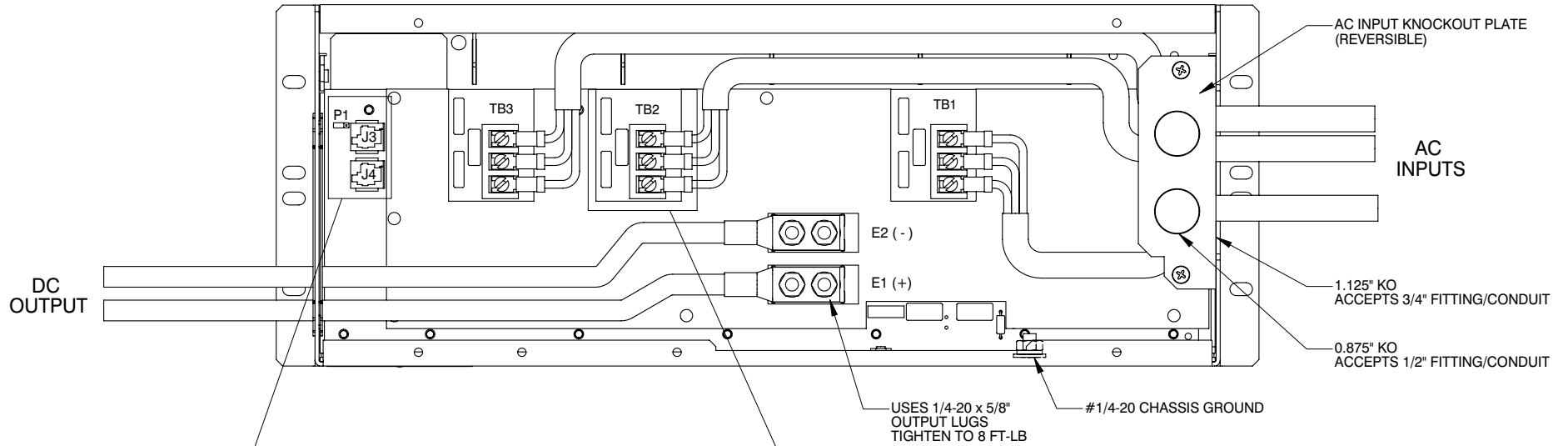

JUMPER SETTING FOR P1

- CAN TERMINATED
- CAN UNTERMINATED

**CAN OUT RJ12 OFFSET
PIN OUT (J3)**

1. GND
2. CAN H
3. NOT CONNECTED
4. CAN L
5. NOT CONNECTED
6. NOT CONNECTED

**CAN IN RJ12 OFFSET
PIN OUT (J4)**

1. GND
2. CAN H
3. NOT CONNECTED
4. CAN L
5. NOT CONNECTED
6. NOT CONNECTED

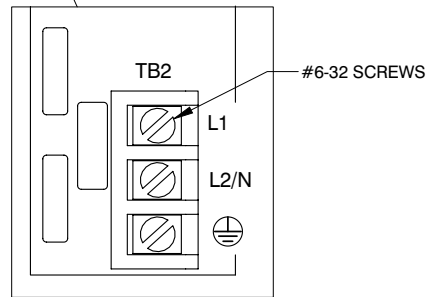

**TYPICAL AC INPUT TERMINAL BLOCK
(TB2 SHOWN)**

TB1 FEEDS RECTIFIERS 1 & 2
 TB2 FEEDS RECTIFIERS 3 & 4
 TB3 FEEDS RECTIFIERS 5 & 6

ARGUS[®]

THESE DESIGNS AND SPECIFICATIONS ARE THE PROPERTY OF ARGUS TECHNOLOGIES AND SHALL NOT BE COPIED OR USED FOR MANUFACTURING WITHOUT ITS WRITTEN CONSENT.

SCALE: NTS

TITLE: CUSTOMER CONNECTION, 6 MODULE, 220-1.1kW

ISSUE DATE: SHEET 2 OF 2

SIZE: B TYPE: D2 DWG NO: 030-718-08 REV: B

© 2004 ARGUS TECHNOLOGIES
 DIMENSIONS ARE IN INCHES.

**Alpha Technologies Ltd.**

7700 Riverfront Gate
Burnaby, BC V5J 5M4
Canada
Tel: +1 604 436 5900
Fax: +1 604 436 1233
Toll Free: +1 800 667 8743

Outback Power

5917 195th St NE,
Arlington, WA 98223
United States
Tel: +1 360 435 6030
Fax: +1 360 435 6019

Alpha Technologies Europe Ltd.

Twyford House Thorley
Bishop's Stortford
Hertfordshire, CM22 7PA
United Kingdom
Tel: +44 1279 501110
Fax: +44 1279 659870

Alpha Technologies

Suite 1903, 191F., Tower 1,
33 Canton Rd. Tsim Sha Tsui
China, Hong Kong City,
Kowloon, Hong Kong
Tel: +852 2736 8663
Fax: +852 2199 7988

**Alpha Energy,
Alpha Technologies Inc.**

3767 Alpha Way
Bellingham, WA 98226
United States
Tel: +1 360 647 2360
Fax: +1 360 671 4936

Alpha Technologies GmbH

Hansastrasse 8
D-91126
Schwabach, Germany
Tel: +49 9122 79889 0
Fax: +49 9122 79889 21

Alphatec Ltd.

339 St. Andrews St.
Suite 101 Andrea Chambers
P.O. Box 56468
3307 Limassol, Cyprus
Tel: +357 25 375 675
Fax: +357 25 359 595

Alpha Innovations Brasil

Rua Manuel Augusto
de Alvarenga, 155
São Paulo, SP - Brasil
Tel: +55 11 2476 0150
Fax: +55 11 2476 0150

Alpha Industrial Power Inc.

1075 Satellite Blvd NW,
Suite 400
Suwanee, GA 30024
United States
Tel: +1 678 475 3995
Fax: +1 678 584 9259

Alpha Technologies S.A.

131 Boulevard de l'Europe
1301 Wavre
Belgium
Tel: +32 10 438 510
Fax: +32 10 438 213

Alpha TEK ooo

Khokhlovskiy Pereulok 16
Stroenie 1, Office 403
Moscow, 109028
Russia
Tel: +7 495 916 1854
Fax: +7 495 916 1349

Alphatec Baltic

S. Konarskio Street 49-201
Vilnius, LT-03123
Lithuania
Tel: +370 5 210 5291
Fax: +370 5 210 5292

For technical support, contact Alpha Technologies:
Canada and USA: 1-888-462-7487
International: +1-604-436-5547

Visit us at www.alpha.ca

Power