

VFD C2000



Delta Electronics -

- VFD-C2000.
(FOC),

(Field Oriented Control)

MODBUS CANOpen
: PROFIBUS-DP, DeviceNet, MODBUS TCP Ethernet/IP

CE, UL cUL

(IP20/NEMA1)
: 230V 0.75...90 , 460V 0.75...355

230 ()	0.75	1.5	2.2	3.7	5.5	7.5	11	15	18.5	22	30	37	45	55	75	90
	A			B			C		D		E			F*		
460 ()	0.75	1.5	2.2	3.7	4.0	5.5	7.5	11	15	18.5	22	30	37	45	55	75
	A			B			C		D							
460 ()	90	110	132	160	185	220	280	315	355							
	E		F*		G*		H*									

II 2010



C2000

VFD-C

FOC-

1. 600
- 2.
3. (/)
4. 4-
- 5.

- 1.
- 2.
- 3.
- 4.



- 1.
- 2.
- 3.
- 4.
- 5.

- 1.
- 2.
- 3.
4. RFI -
- 5.

50°
DC

(CE, UL, cUL)

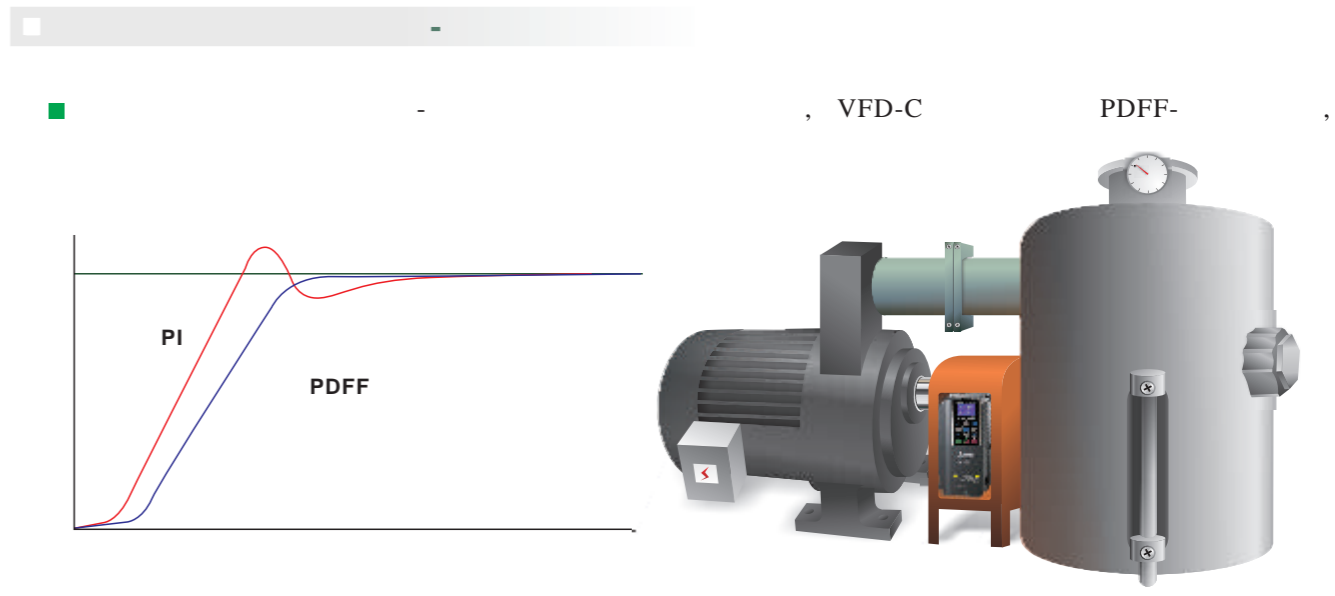
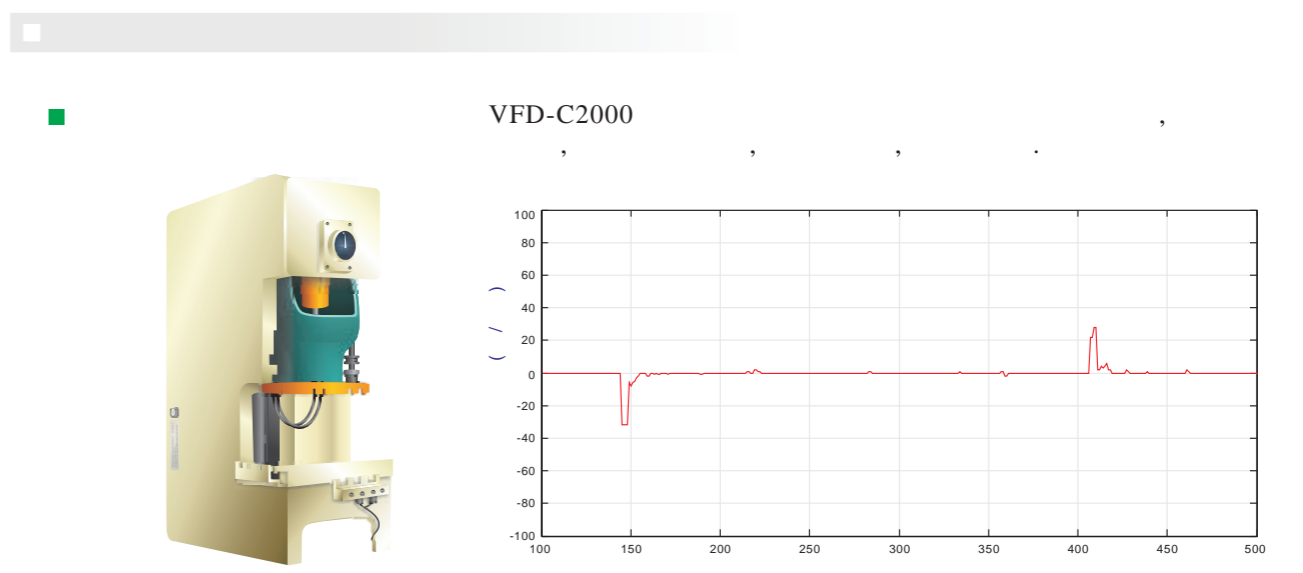
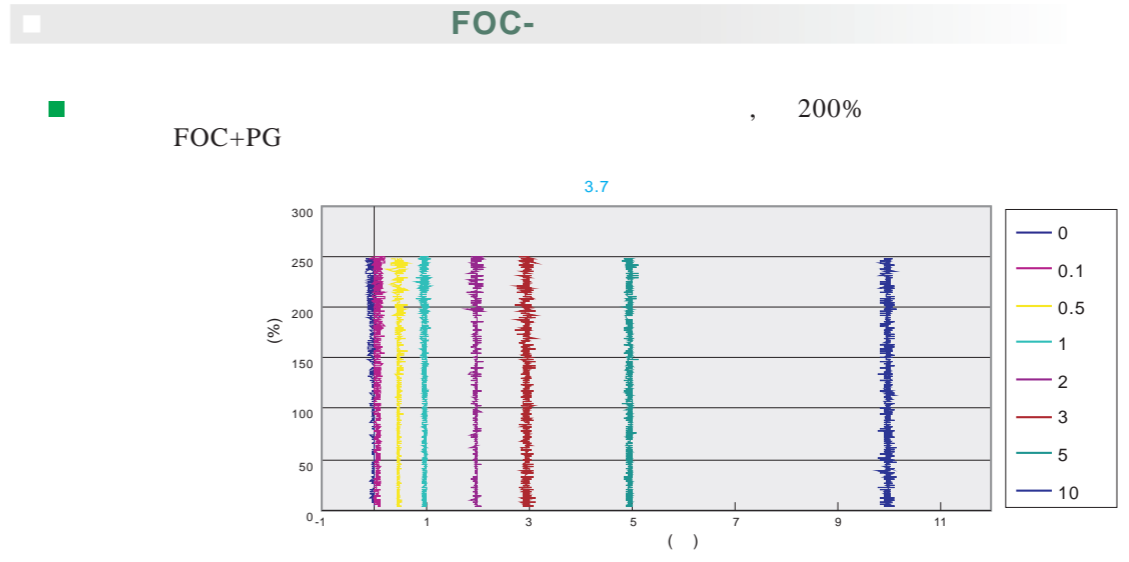
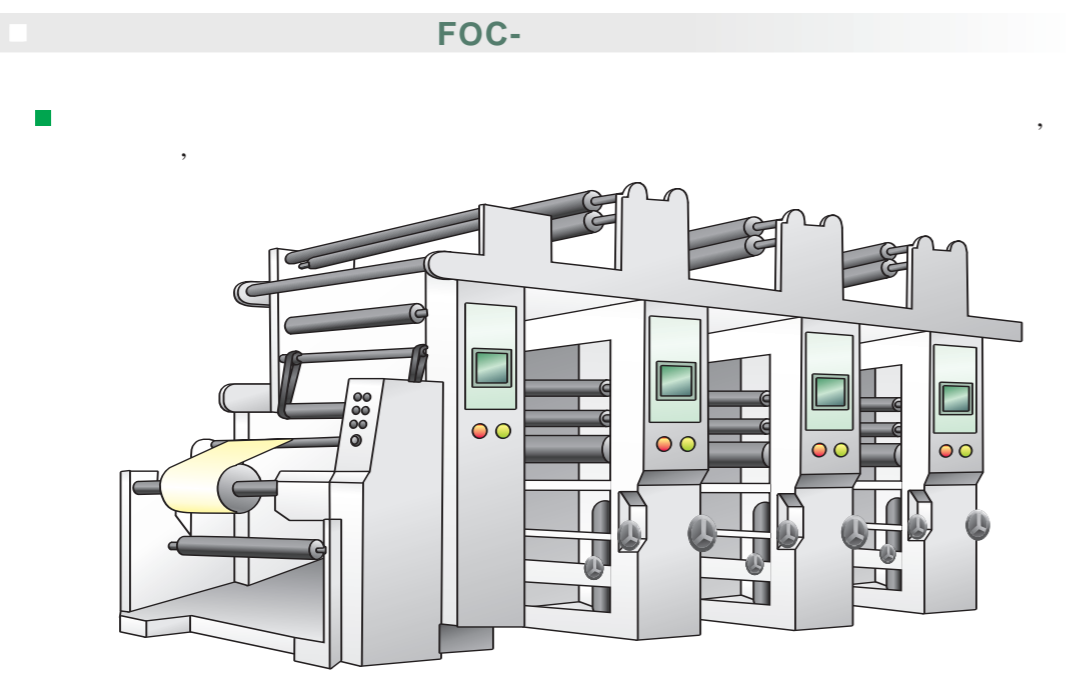
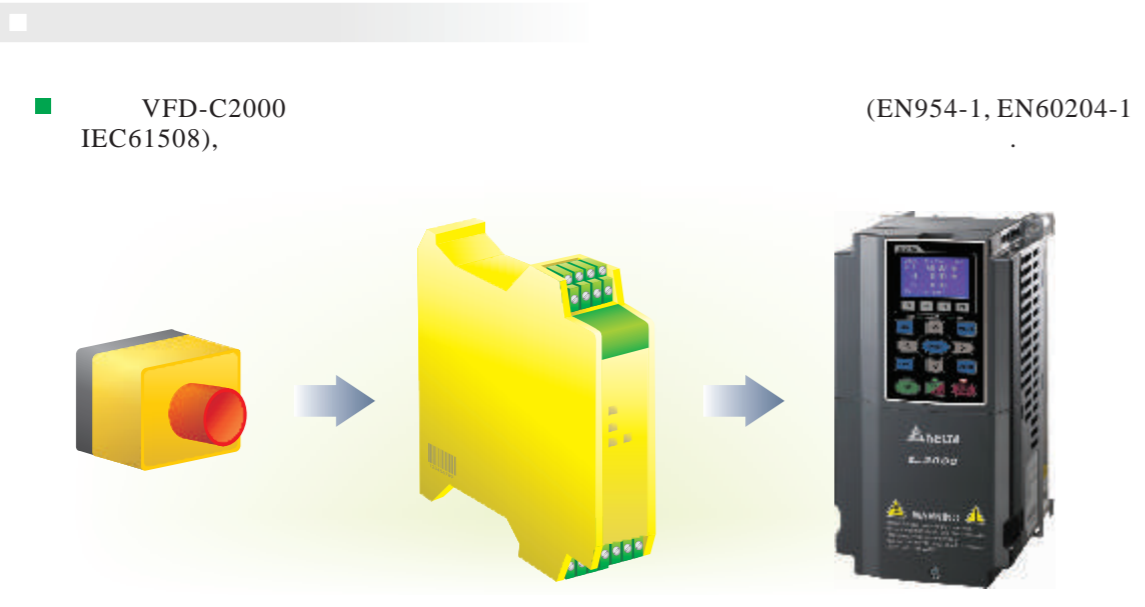

VFD-C

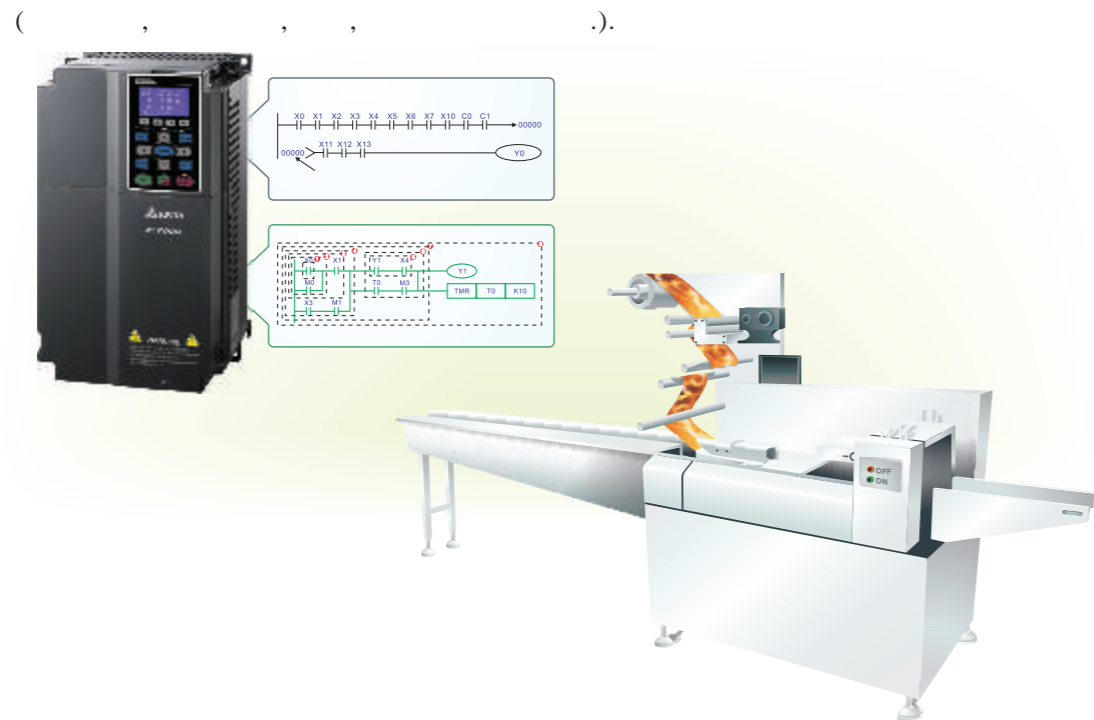

VFD-C2000

2- -1

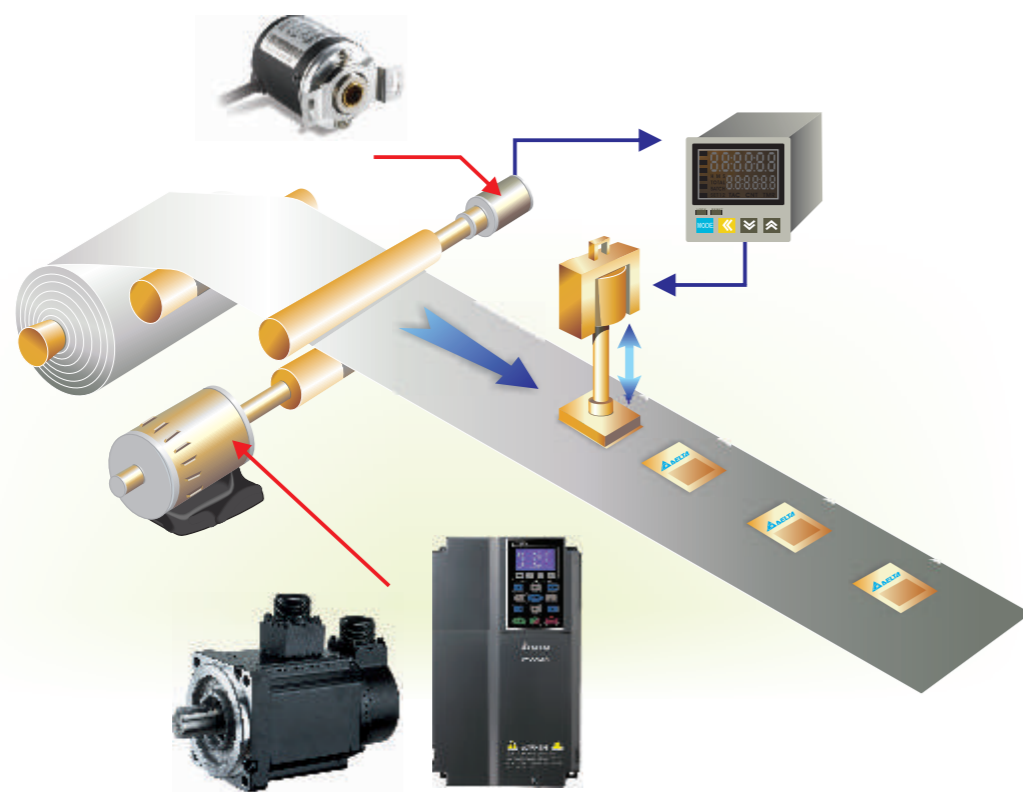

VFD-C

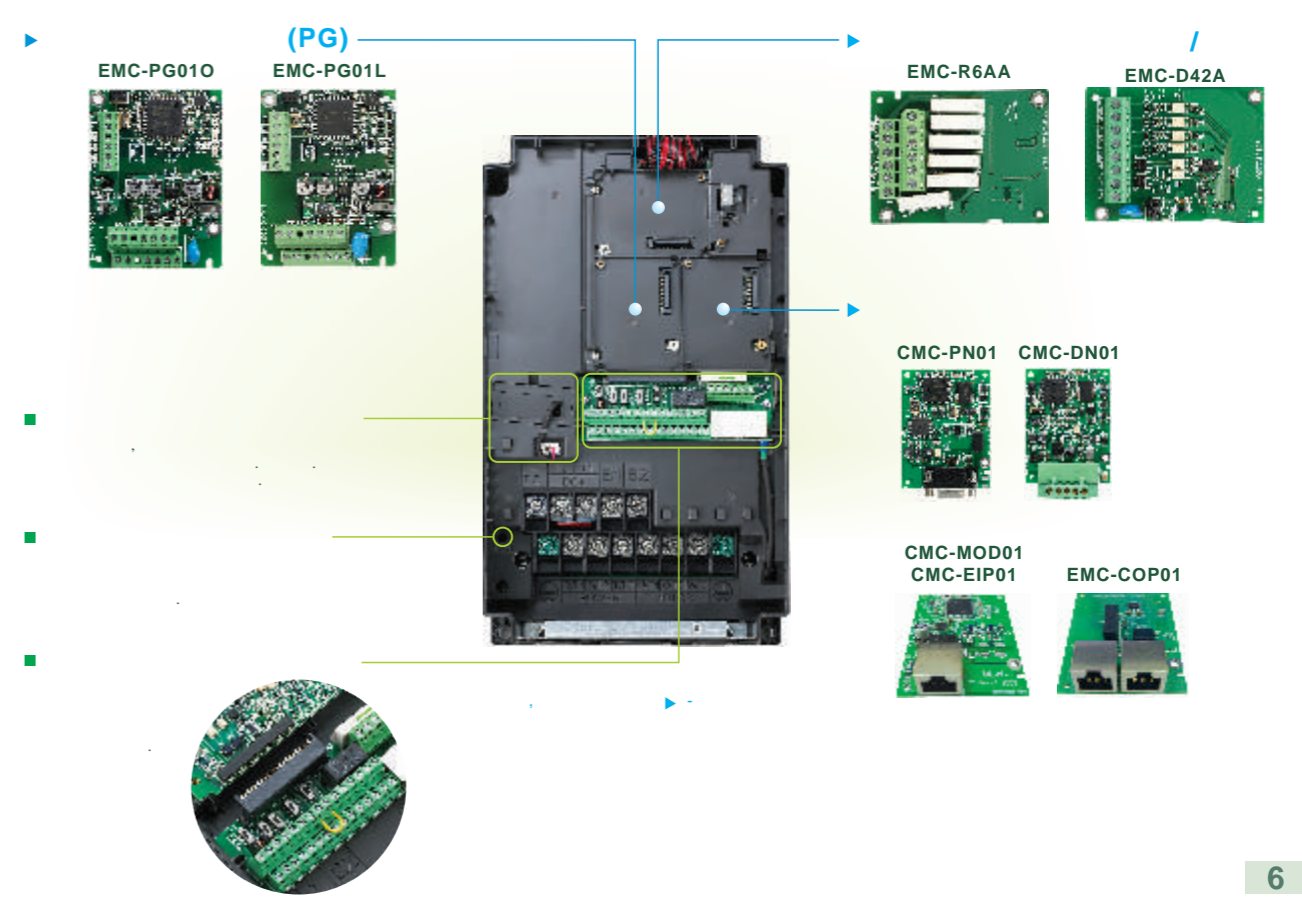

- RS-485



- CANopen (DS402),

Delta

CANopen Builder,
CANopen.

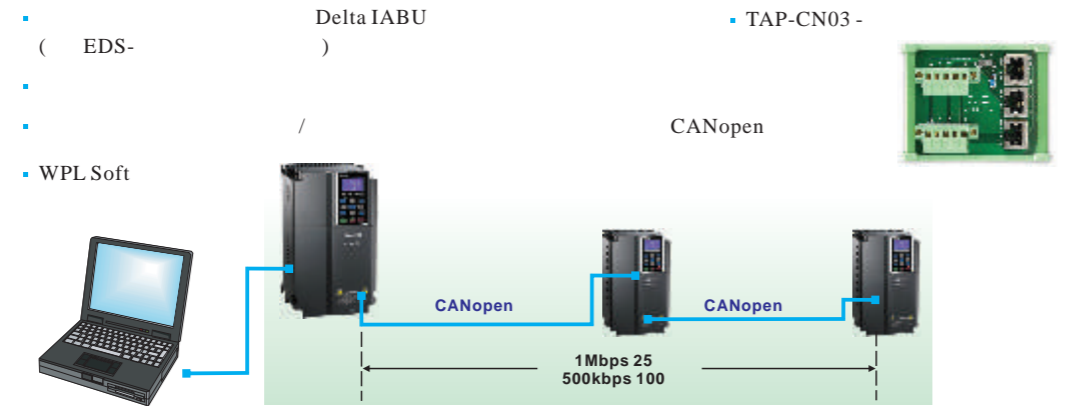

Delta DeviceNet Builder

DeviceNet

- (EDS-)
- DeviceNet



- MODBUS TCP

DCI Soft



Ethernet

- Delta Ethernet/Modbus TCP

COM-

- RFI- IEC/EN61000-3-2, 61000-3-12 61800-3.



- (1)
- (2)

 <p>A</p>	230 : 0.75~3.7 (1~5HP)	VFD007C23A/E VFD037C23A/E VFD007C43A/E VFD015C43A/E VFD037C43A/E VFD040C43A/E VFD055C43A/E	[MKC-AFM]
	460 : 0.75~5.5 (1~7.5HP)	VFD015C23A/E VFD022C23A/E VFD022C43A/E	[MKC-AFM1]
 <p>B</p>	230 : 5.5~11 (7.5~15HP)	VFD055C23A/E VFD075C23A/E VFD110C23A/E VFD075C43A/E VFD110C43A/E VFD150C43A/E	[MKC-BFM]
	460 : 7.5~15 (10~20HP)		
 <p>C</p>	230 : 15~22 (20~30HP)	VFD150C23A/E VFD185C23A/E VFD220C23A/E VFD185C43A/E VFD220C43A/E VFD300C43A/E	[MKC-CFM]
	460 : 18.5~30 (25~40HP)		
 <p>D</p>	230 : 30~37 (40~50HP)	VFD300C23A VFD370C23A VFD370C43A VFD450C43A VFD550C43A VFD750C43A VFD300C23E VFD370C23E VFD370C43E VFD450C43E VFD550C43E VFD750C43E	▶ Conduit box kit [MKC-DN1CB]
	460 : 37~75 (50~100HP)		
 <p>E</p>	230 : 45~75 (60~100HP)	VFD450C23A/E VFD550C23A/E VFD750C23A VFD900C43A/E VFD1100C43A/E VFD750C23E	▶ Conduit box kit [MKC-EN1CB]
	460 : 90~110 (125~150HP)		
 <p>F</p>	230 : 90 (125HP)	VFD900C23A/E VFD1320C43A/E VFD1600C43A/E	2010 . II .
	460 : 132~160 (175~215HP)		
 <p>G</p>	460 : 185~220 (250~300HP)	VFD1850C43A/E VFD2200C43A/E	2010 . II .
 <p>H</p>	460 : 280~355 (375~475HP)	VFD2800C43A/E VFD3150C43A/E VFD3550C43A/E	2010 . II .

MODEL:VFD007C43A

INPUT:
Normal Duty: 3PH 380-480V 50/60Hz 4.3A
Heavy Duty: 3PH 380-480V 50/60Hz 4.1A

OUTPUT:
Normal Duty: 3PH 0-480V 3A 2.4KVA 1HP
Heavy Duty: 3PH 0-480V 2.9A 2.3KVA 1HP

FREQUENCY RANGE:
Normal Duty: 0-600Hz
Heavy Duty: 0-300Hz

Version: VX.XX

(IPXX)



007C43A7T9300002

DELTA DELTA ELECTRONICS, INC.
MADE IN XXXXXXX









VFD 007 C 43 A

23: 230V 3-
43: 460V 3-

C2000

007: 0.75 ~ 1100: 110

(Variable Frequency Drive)

	CMC-EIP01 CMC-MOD01		EtherNet/IP (CMC-EIP01) MODBUS TCP (CMC-MOD01) 10/100 / ,
	CMC-PN01		DP-PROFIBUS 9.6 / , 19.2 / , 96.75 / , 187.5 / , 500 / , 1.5 / , 3 / , 6 / 12 /
	CMC-DN01		DeviceNet 125 / , 250 / , 500 /
	EMC-COP01		CANopen 1 500k 250k 125k 100k 50k
	EMC-R6AA		(6)
	EMC-D42A		(4 2 /)
(PG)	EMC-PG01O		PG : V+ (, PLC) : 300
	EMC-PG01L		PG : : 5VDC : 50 : 300
	KPC-CE01		7- LED- , (MKC-KPPK) , IP56.

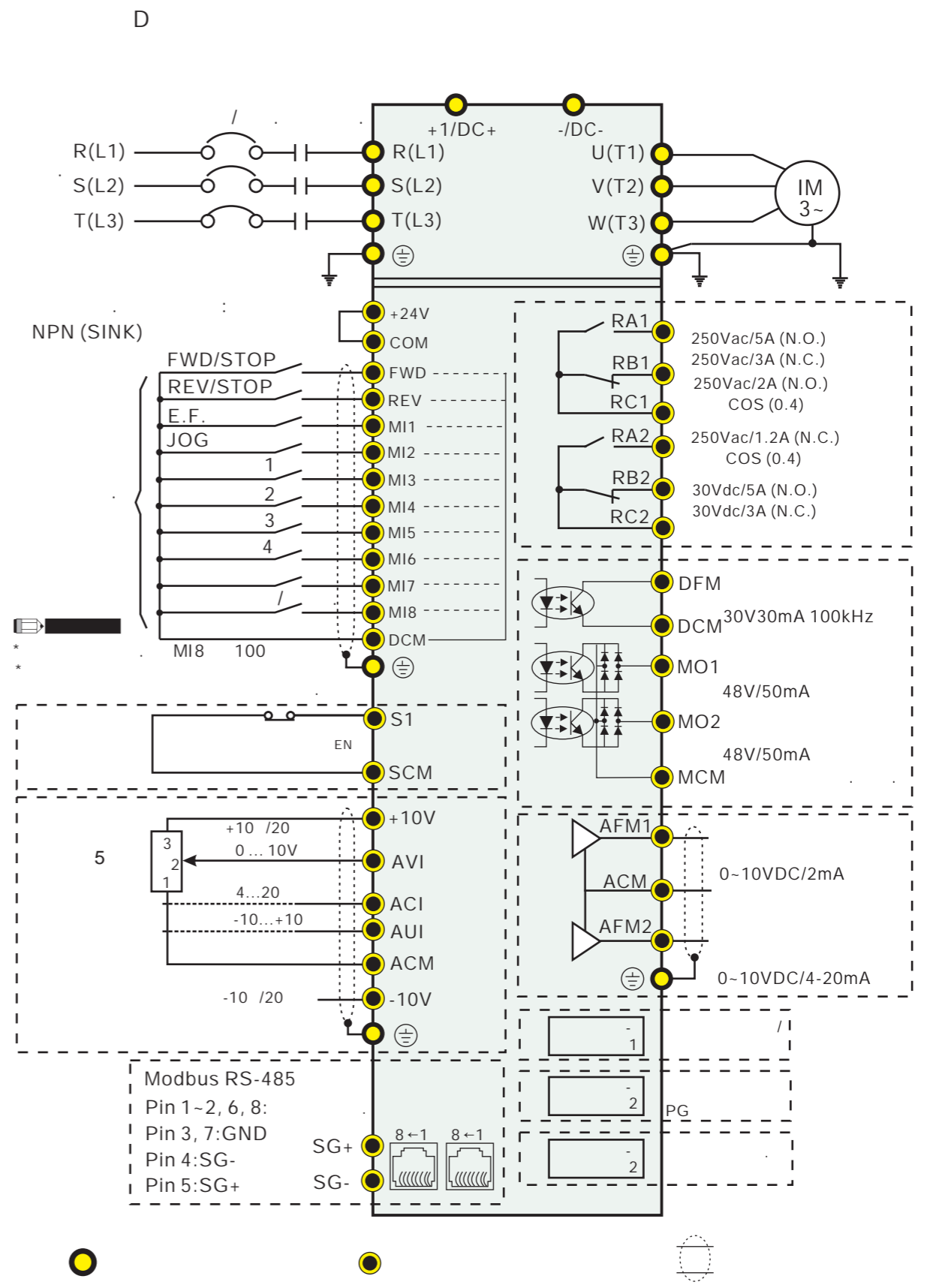
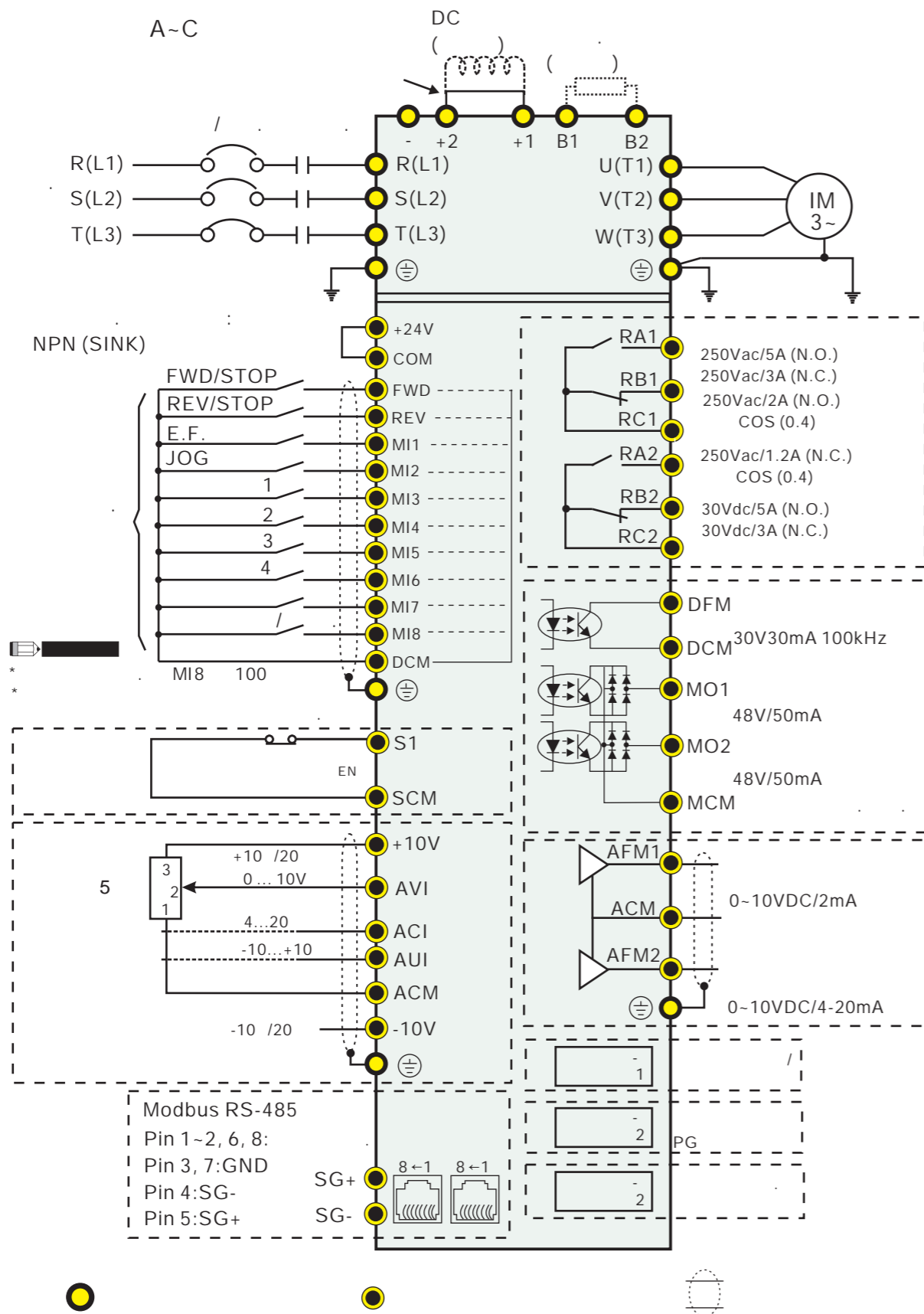

230V		A				B			C			D		E		
VFD-__C__		007	015	022	037	055	075	110	150	185	220	300	370	450	550	750
()		0.75	1.5	2.2	3.7	5.5	7.5	11	15	18.5	22	30	37	45	55	75
(..)		1	2	3	5	7.5	10	15	20	25	30	40	50	60	75	100
()		1.9	2.8	4.0	6.4	9.6	12	19	25	28	34	45	55	68	81	96
(A)		4.8	7.1	10	16	24	31	47	62	71	86	114	139	171	204	242
()		2-6														
()		2.0	3.2	4.4	6.8	10	13	20	26	30	36	48	58	72	86	102
(A)		5	8	11	17	25	33	49	65	75	90	120	146	180	215	255
()		2-15					2-10					2-9				
(A)		6.1	11	15	18.5	26	34	50	68	78	95	118	136	162	196	233
(A)		6.4	12	16	20	28	36	52	72	83	99	124	143	171	206	245
/		3- AC 200 (-15%)...240 (+10%), 50/60														
		170-265Vac														
		47-63														
EMI-																

1: V/F, 2: SVC, 3: VF+PG, 4: FOC+PG	150%	0.5	150%	0	1
V/f	4				
5 ()	40				
.200%					
±5%					
()	: 0.01~600.00		: 0.00~300.00		
	: ±0.01%, -10...+40°		: ±0.1%, 25±10°		
	: 0.01		: 0.03/60 (±11)		
	: 120%		1		
	: 150%		1		
/	+10...-10, 0...10, 4...20, 0...20				
J	0.00...600.00/0.0...6000.0				
	MODBUS (RS-485 (RJ45)) 115.2 / ,				
	B		C		
	: 240%				
	: 170~175%;		: 180~185%		
230:	DC		410		
460:	DC		820		
	20				
	: 50%				

460V		A					B			C			D			E				
VFD-__C__		007	015	022	037	040	055	075	110	150	185	220	300	370	450	550	750	900	1100	
()		0.75	1.5	2.2	3.7	4.0	5.5	7.5	11	15	18.5	22	30	37	45	55	75	90	110	
(..)		1	2	3	5	5	7.5	10	15	20	25	30	40	50	60	75	100	125	150	
()		2.3	3.0	4.5	6.5	7.6	9.6	14	18	24	29	34	45	55	69	84	114	136	167	
(A)		2.9	3.8	5.7	8.1	9.5	11	17	23	30	36	43	57	69	86	105	143	171	209	
()		2-6																		
()		2.4	3.2	4.8	7.2	8.4	10	14	19	25	30	36	48	58	73	88	120	143	175	
(A)		3.0	4.0	6.0	9.0	10.5	12	18	24	32	38	45	60	73	91	110	150	180	220	
()		2-15					2-10					2-9								
(A)		4.1	5.6	8.3	13	14.5	16	19	25	33	38	45	60	70	96	108	149	159	197	
(A)		4.3	5.9	8.7	14	15.5	17	20	26	35	40	47	63	74	101	114	157	167	207	
/		3- AC 38 (-15%)...480 (+10%), 50/60																		
		323~528Vac																		
		47-63																		
EMI-		VFDXXXC43A: EMI-					EMI-					VFDXXXC43A: con du it box kit; VFDXXX43E: NEMA1								

IEC60364-1/IEC60664-1	2,
NEMA 1/UL Type 1	2% 1° : -10...+40°
UL Open Type	2% 1° : -10...+50°
/	-25...+70°
	.90%
/	.95%
/	86...106
	70...106
IEC60721-3-3 (application is in progress)	
	Class 3C2; Class 3S2
	Class 2C2; Class 2S2
	Class 1C2; Class 1S2
	1000 2% 0.5°C 1000...3000 100
/	ISTA procedure 1A() IEC60068-2-31
1.5	, 3-13 , 1G 13-200 (IEC 60068-2-6)
15G	11 (IEC/EN 60068 2-27)
	±10°

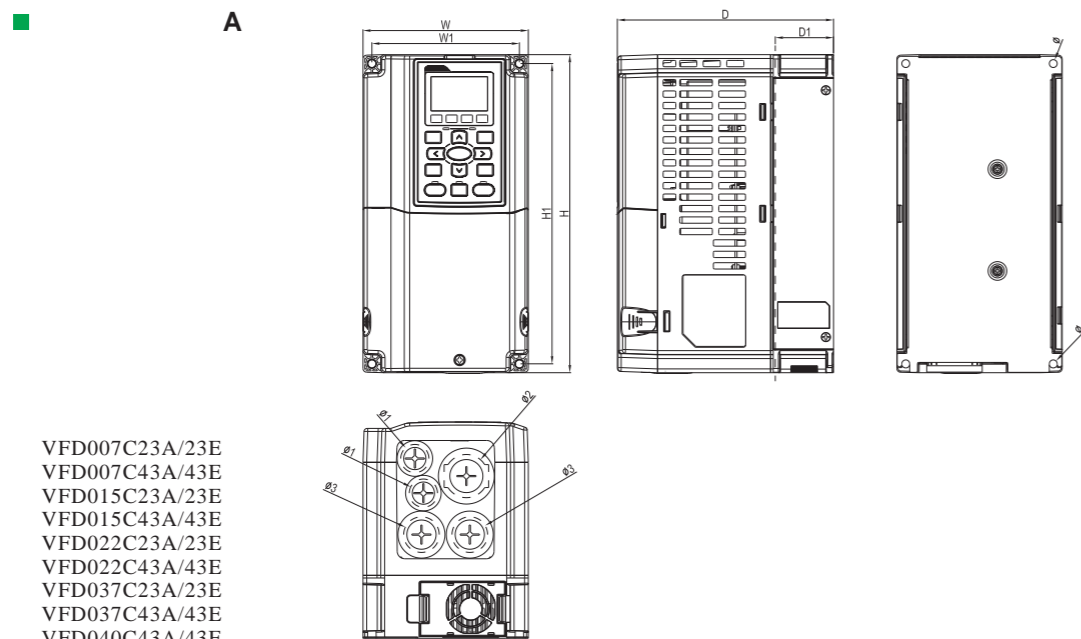

VFD007C23A/23E
 VFD007C43A/43E
 VFD015C23A/23E
 VFD015C43A/43E
 VFD022C23A/23E
 VFD022C43A/43E
 VFD037C23A/23E
 VFD037C43A/43E
 VFD040C43A/43E
 VFD055C43A/43E

	W	H	D	W1	H1	D1*	Ø	Ø1	Ø2	Ø3
A	130.0	250.0	170.0	116.0	236.0	45.8	6.2	22.2	34.0	28.0
	5.12	9.84	6.69	4.57	9.29	1.80	0.24	0.87	1.34	1.10

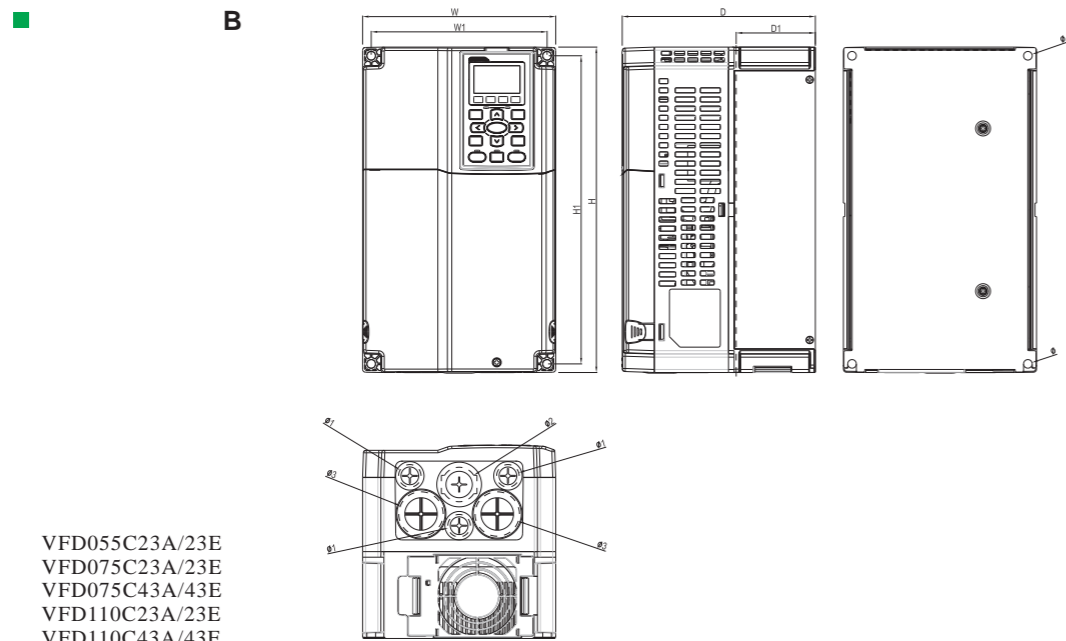

VFD055C23A/23E
 VFD075C23A/23E
 VFD075C43A/43E
 VFD110C23A/23E
 VFD110C43A/43E
 VFD150C43A/43E

	W	H	D	W1	H1	D1*	Ø	Ø1	Ø2	Ø3
B	190.0	320.0	190.0	173.0	303.0	77.9	8.5	22.2	34.0	43.8
	7.48	12.60	7.48	6.81	11.93	3.07	0.33	0.87	1.34	1.72

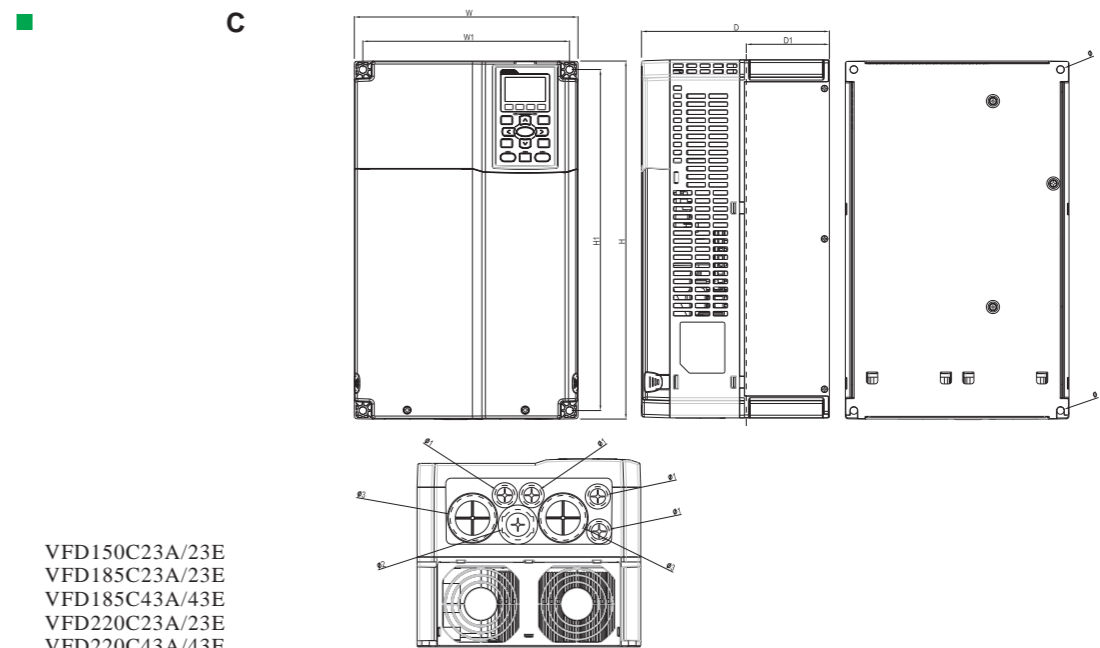

VFD150C23A/23E
 VFD185C23A/23E
 VFD185C43A/43E
 VFD220C23A/23E
 VFD220C43A/43E
 VFD300C43A/43E

	W	H	D	W1	H1	D1*	Ø	Ø1	Ø2	Ø3
C	250.0	400.0	210.0	231.0	381.0	92.9	8.5	22.2	34.0	50.0
	9.84	15.75	8.27	9.09	15.00	3.66	0.33	0.87	1.34	1.97

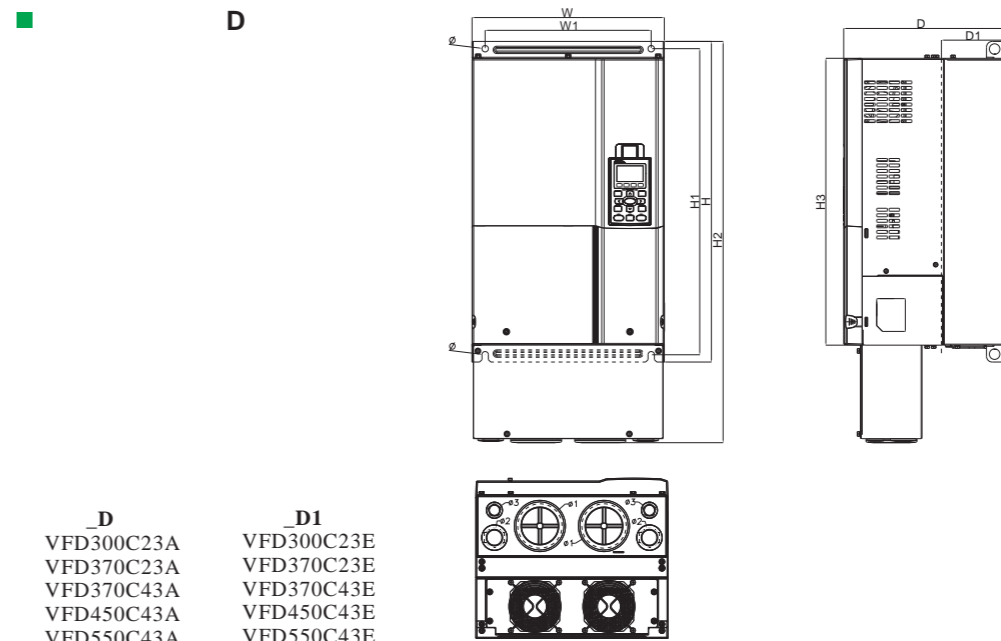

_D
 VFD300C23A
 VFD370C23A
 VFD370C43A
 VFD450C43A
 VFD550C43A
 VFD750C43A

_D1
 VFD300C23E
 VFD370C23E
 VFD370C43E
 VFD450C43E
 VFD550C43E
 VFD750C43E

	W	H	D	W1	H1	H2	H3	D1*	Ø	Ø1	Ø2	Ø3
D	330.0 [12.99]	550.0 [21.65]	275.0 [10.83]	285.0 [11.22]	525.0 [20.67]	-	492.0 [19.37]	107.2 [4.22]	11.0 [0.43]	34.0 [1.34]	22.0 [0.87]	11.0 [0.43]
D1	330.0 [12.99]	550.0 [21.65]	275.0 [10.83]	285.0 [11.22]	525.0 [20.67]	688.3 [27.10]	492.0 [19.37]	107.2 [4.22]	11.0 [0.43]	34.0 [1.34]	22.0 [0.87]	11.0 [0.43]

E

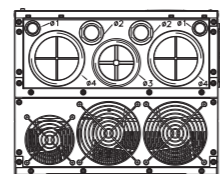
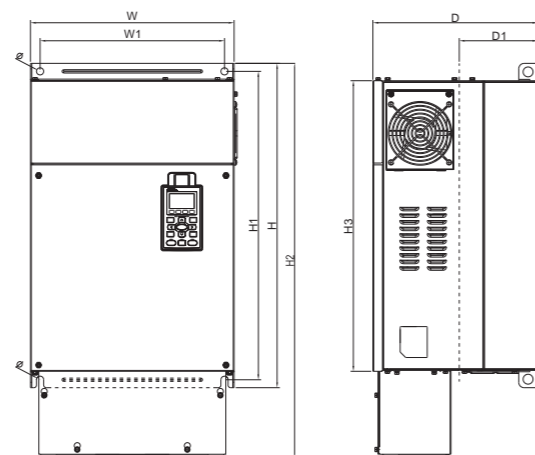

_E	_E1
VFD450C23A	VFD450C23E
VFD550C23A	VFD550C23E
VFD900C43A	VFD900C43E
VFD1100C43A	VFD1100C43E

	W	H	D	W1	H1	H2	H3	D1*	Ø	Ø1	Ø2	Ø3	Ø4
E	370.0 [14.57]	589.0 [23.19]	300.0 [11.81]	335.0 [13.19]	560.0 [22.05]	-	528.0 [20.80]	143.0 [5.63]	13.0 [0.51]	22.0 [0.87]	34.0 [1.34]	76.0 [2.99]	92.0 [3.62]
E1	370.0 [14.57]	589.0 [23.19]	300.0 [11.81]	335.0 [13.19]	560.0 [22.05]	715.8 [28.18]	528.0 [20.80]	143.0 [5.63]	13.0 [0.51]	22.0 [0.87]	34.0 [1.34]	76.0 [2.99]	92.0 [3.62]

E1*:

