



TP70P Quick Start

TP70P Quick Start

Table of Contents

Chapter 1 Introduction

1.1	Introduction of TP70P	1-2
1.2	Related Manuals	1-2
1.3	Profile and Dimensions	1-3
1.3.1	Profile	1-3
1.3.2	Dimensions of TP70P	1-4
1.3.3	Dimensions of an Opening.....	1-5
1.4	Definitions of External Connectors	1-5
1.5	Functional Specifications	1-6
1.5.1	Arrangement of I/O Terminals.....	1-6
1.5.2	Devices in a PLC	1-7
1.6	Electrical Specifications.....	1-8
1.6.1	Specifications for PLCs.....	1-8
1.6.2	Electrical Specifications for Digital Input Terminals.....	1-9
1.6.3	Electrical Specifications for Digital Output Terminals.....	1-9
1.6.4	Electrical Specifications for Analog I/O Terminals	1-10
1.7	Installation	1-11
1.8	Wiring	1-12
1.8.1	Wiring a Power Input Connector	1-12
1.8.2	Wiring Input Terminals.....	1-13
1.8.3	Wiring Relay Output Terminals	1-13
1.8.4	Wiring Analog Input Channels	1-14
1.8.5	Wiring Analog Output Channels.....	1-15
1.8.6	Wiring Temperature Measurement Input Terminals.....	1-16
1.9	Definitions of the Pins in Communication Ports	1-16
1.10	Controllers Supporting TP70P	1-17

Chapter 2 Writing Programs

2.1	Preparations.....	2-2
2.1.1	Hardware.....	2-2
2.1.2	Software.....	2-2
2.1.3	Tools and Materials.....	2-2
2.2	Wiring	2-2
2.2.1	Wiring Diagram for a Delta VFD-M Series AC Motor Drive.....	2-3

2.2.2	Wiring Diagram for External Terminals	2-3
2.2.3	Wiring Diagram for Communication	2-3
2.2.4	Setting Parameteres in a Delta VFD-M Series AC Motor Drive	2-4
2.3	Example.....	2-4
2.4	Writing a Program for a Text Panel.....	2-5
2.4.1	Planning Objects	2-7
2.4.2	Managing Pages	2-7
2.4.3	Creating Objects.....	2-8
2.4.4	Basic Configuration	2-15
2.4.5	Compile and Downloading a Program.....	2-16
2.5	Writing a Program for a PLC	2-18
2.5.1	Planning a Program.....	2-20
2.5.2	Control Program	2-21
2.5.3	Compiling and Downloading a Program	2-22
2.6	Monitoring and Debugging a Program	2-23
2.6.1	Monitoring a Program.....	2-23
2.6.2	Removing System Errors	2-27

Chapter 3 Frequently Asked Questions and Answers

3.1	Installing a USB Driver	3-2
3.2	Descriptions of the Communication Ports on TP70P.....	3-4
3.3	Setting COM2.....	3-5
3.4	Using COM2 as a Master Station	3-6
3.5	Setting COM3.....	3-7
3.6	Setting an RTU Mode for COM3.....	3-9
3.7	Using COM3 as a Slave Station	3-10
3.8	Data Exchange	3-12

1

Chapter 1 Introduction

Table of Contents

1.1	Introduction of TP70P	1-2
1.2	Related Manuals	1-2
1.3	Profile and Dimensions	1-3
1.3.1	Profile	1-3
1.3.2	Dimensions of TP70P	1-4
1.3.3	Dimensions of an Opening.....	1-5
1.4	Definitions of External Connectors	1-5
1.5	Functional Specifications	1-6
1.5.1	Arrangement of I/O Terminals.....	1-6
1.5.2	Devices in a PLC	1-7
1.6	Electrical Specifications.....	1-8
1.6.1	Specifications for PLCs.....	1-8
1.6.2	Electrical Specifications for Digital Input Terminals.....	1-9
1.6.3	Electrical Specifications for Digital Output Terminals.....	1-9
1.6.4	Electrical Specifications for Analog I/O Terminals	1-10
1.7	Installation	1-11
1.8	Wiring	1-12
1.8.1	Wiring a Power Input Connector	1-12
1.8.2	Wiring Input Terminals.....	1-13
1.8.3	Wiring Relay Output Terminals	1-13
1.8.4	Wiring Analog Input Channels	1-14
1.8.5	Wiring Analog Output Channels.....	1-15
1.8.6	Wiring Temperature Measurement Input Terminals.....	1-16
1.9	Definitions of the Pins in Communication Ports	1-16
1.10	Controllers Supporting TP70P	1-17



1.1 Introduction of TP70P

TP70P is highly flexible in that it can be connected to various devices. The devices which can be connected to TP70P are shown in the block diagram below.

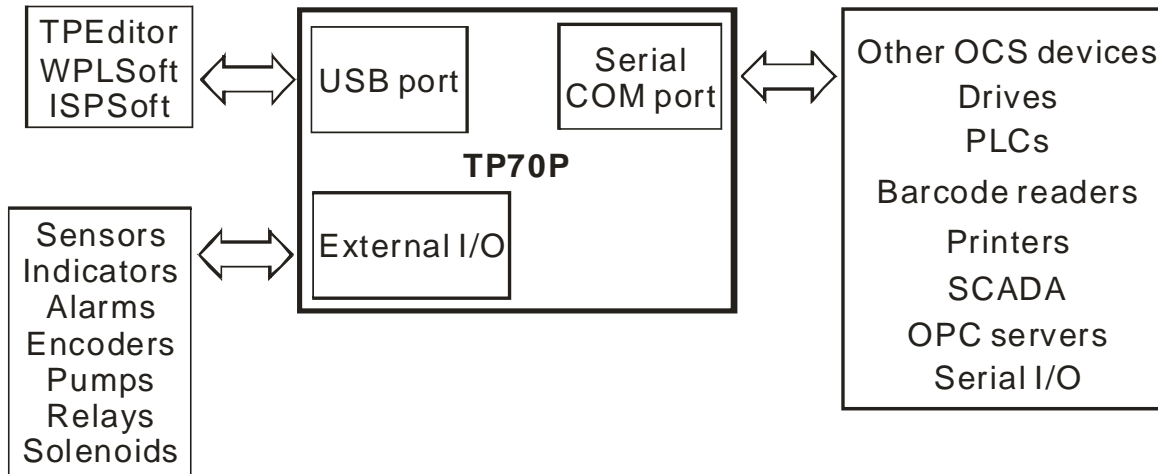

The functions of TP70P are described below.

- The LCD on TP70P can display 65535, and is a touchscreen.
- TP70P provides various kinds of objects, including X-Y curves, circular meters, bars, sliders, and alarms.
- TP70P supports PLC Links.
- The driver in TP70P supports Delta controllers. It can be connected to Delta servers, inverters, and temperature controllers.
- There are two serial communication ports. One supports PLC communication, and the other supports TP70P communication.
- The USB port on TP70P can communicate with a computer. It supports the use of WPLsoft/ISPSoft/TPEditor to upload/download a program and to monitor devices.
- There are four models which have different I/O configurations. They can be connected to various types of output devices.

1.2 Related Manuals

The manuals related to TP70P are described below.

- TP70P Instruction Sheet: TP70P Instruction Sheet provides information related to TP70P for users who use TP70P for the first time. (TP70P Instruction Sheet is attached to a TP70P series text panel.)
- DVP-ES2/EX2/SS2/SA2/SX2/SE&TP Operation Manual: DVP-ES2/EX2/SS2/SA2/SX2/SE&TP Operation Manual Introduces the PLC instructions supported by TP70P. Users can find the manual on the Delta website.
- TPEditor User Manual: TPEditor User Manual introduces the usage of TPEditor, including the interface of TPEditor, and the objects which can be displayed on a text panel. Users can find the manual on the Delta website or in TPEditor.
- WPLSoft User Manual: WPLSoft User Manual introduces the usage of WPLSoft, including the interface of WPLSoft, and the objects which can be used. Users can find the manual in WPLSoft.
- ISPSoft User Manual: ISPSoft User Manual introduces the usage of ISPSoft, including variables, connections, programs, and function blocks. Users can find the manual on the Delta website or in ISPSoft.
- TP70P Quick Start: TP70P Quick Start introduces the functions of TP70P, the wiring of TP70P, the installation of TP70P, the system of TP70P, and the usage of TP70P.

1.3 Profile and Dimensions

1.3.1 Profile

1

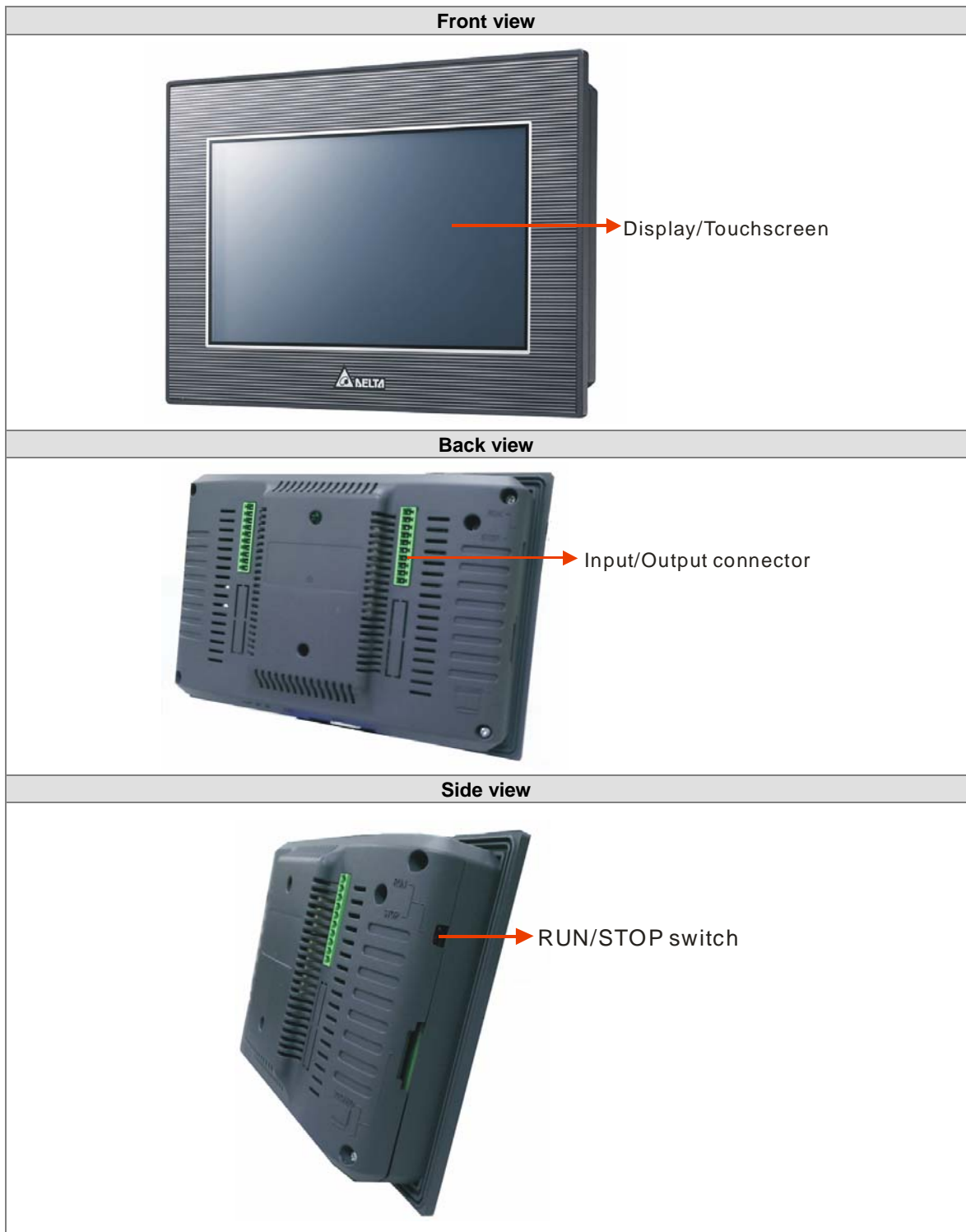

1

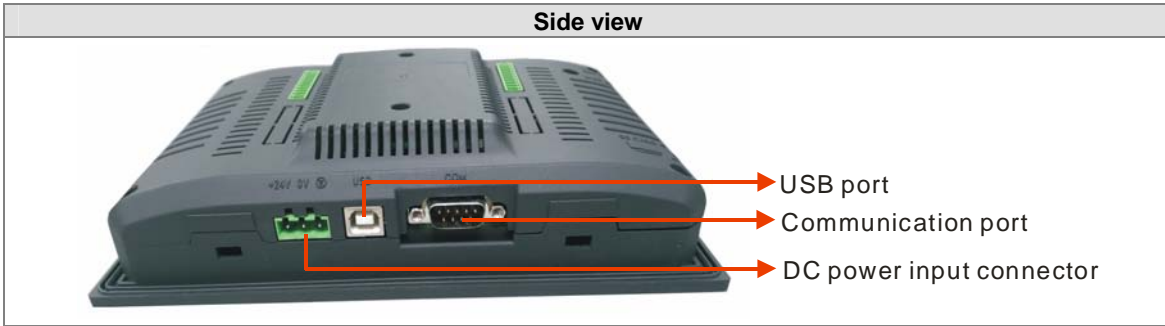

1.3.2 Dimensions of TP70P

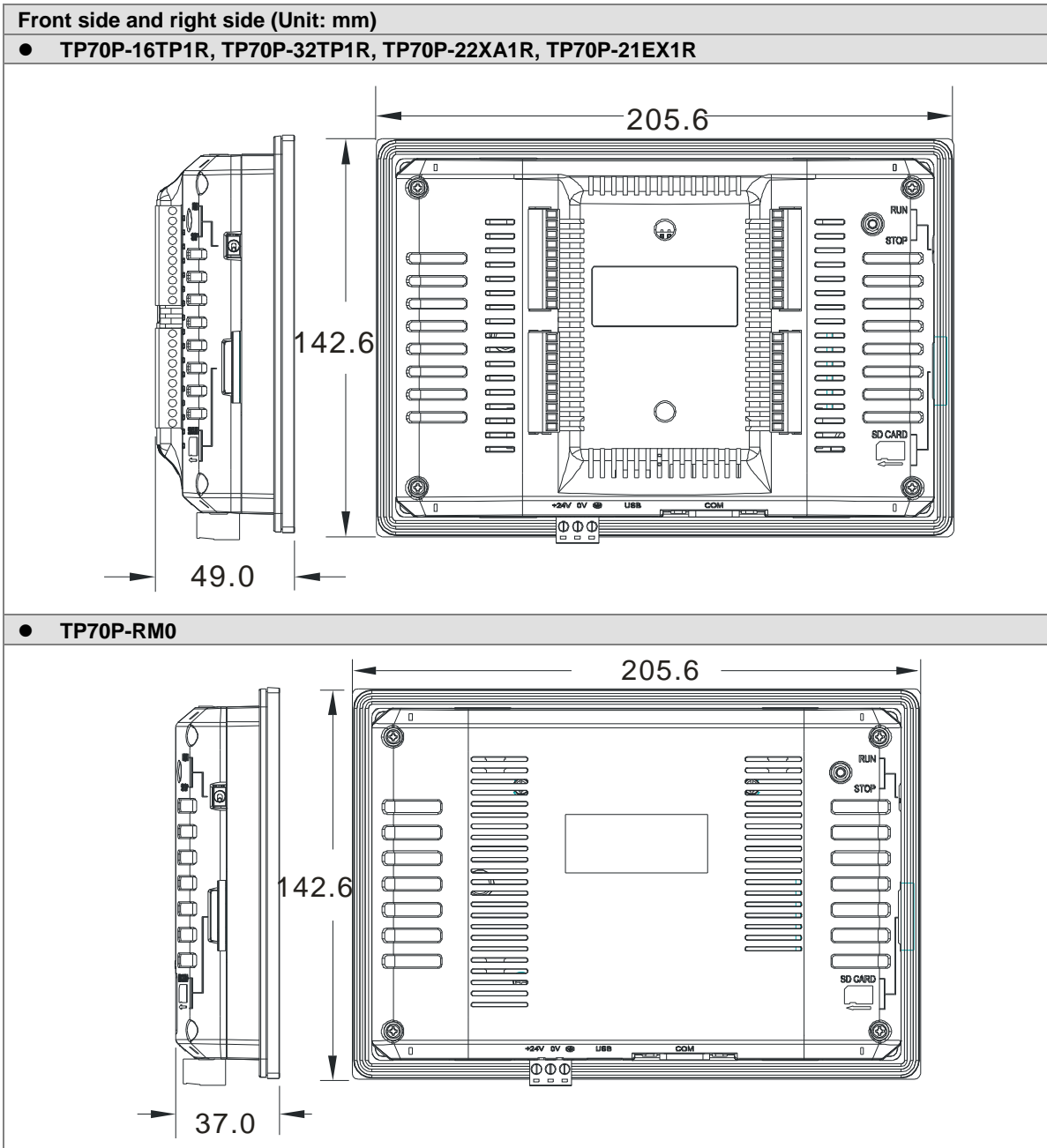



1.3.3 Dimensions of an Opening

If protection against water is required (NEMA 4X), a hole should be made to a tolerance of ± 0.1 mm.

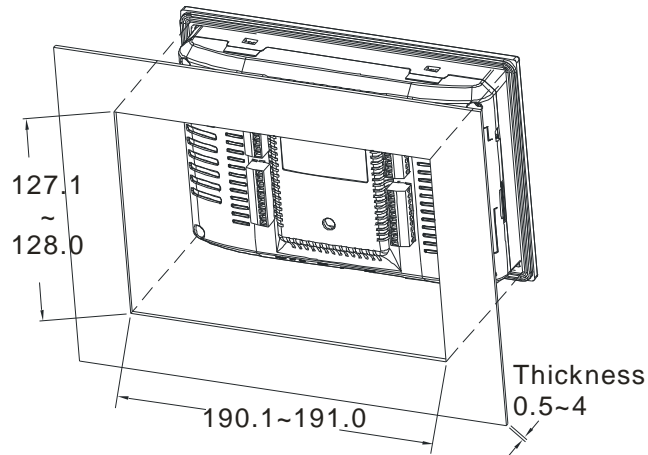

Unit: mm

1.4 Definitions of External Connectors

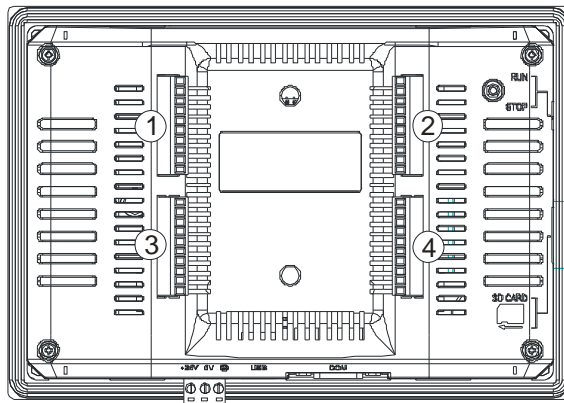

TP70P-16TP1R	
①	②
S/S	C0
X0	Y0
X1	Y1
X2	Y2
X3	Y3
X4	Y4
X5	Y5
X6	Y6
X7	Y7
.	.

TP70P-32TP1R			
①	②	③	④
S/S0	C0	S/S0	C1
X0	Y0	X10	Y10
X1	Y1	X11	Y11
X2	Y2	X12	Y12
X3	Y3	X13	Y13
X4	Y4	X14	Y14
X5	Y5	X15	Y15
X6	Y6	X16	Y16
X7	Y7	X17	Y17
.	.	.	.

TP70P-22XA1R			
①	②	③	④
S/S0	C0	V0+	V3+
X0	Y0	VI0-	VI3-
X1	Y1	I0+	I3+
X2	Y2	V1+	FE
X3	Y3	VI1-	VO4
X4	Y4	I1+	IO4
X5	Y5	V2+	AG
X6	Y6	VI2-	VO5
X7	Y7	I2+	IO5
.	.	FE	AG

TP70P-21EX1R			
①	②	③	④
S/S0	C0	I0+	L3+
X0	Y0	I0-	L3-
X1	Y1	FE	I3-
X2	Y2	I1+	FE
X3	Y3	I1-	.
X4	Y4	FE	L4+
X5	Y5	.	L4-
X6	Y6	IO2	I4-
X7	Y7	AG	FE
.	.	FE	.



1.5 Functional Specifications

Specifications		Model	TP70P -32TP1R	TP70P -16TP1R	TP70P -22XA1R	TP70P -21EX1R	TP70P -RM0
Display	Screen/Color	7" TFT LCD (65535 colors)					
	Resolution	800×480 pixels					
	Backlight type	LED backlight (It has a lifespan of twenty thousand hours at a temperature of 25°C)					
	Display area	Width × Height = 154 × 85 (Unit: mm); 7 inches (diagonal)					
Driver		Delta product					
USB port		Transmission: Virtual communication port Data length: 7 bits or 8 bits Stop bit: 1 bit or 2 bits Parity check: None/Odd/Even Transmission rate: 9,600 bps~115,200 bps USB port: Type B USB connector					
Extension communication ports	COM2	RS-485					RS-232
		Data length: 7 bits or 8 bits Stop bit: 1 bit or 2 bits Parity check: None/Odd/Even Transmission rate: 9,600 bps~115,200 bps Connector: Male DB-9 connector (Please refer to section 1.9 for more information.)					
	COM3	RS-485/RS-422					RS-485
		Data length: 7 bits or 8 bits Stop bit: 1 bit or 2 bits Parity check: None/Odd/Even Transmission rate: 9,600 bps~115,200 bps Connector: Male DB-9 connector (Please refer to section 1.9 for more information.)					
Monitoring devices		After a program is downloaded to a text panel by means of the virtual communication port on the text panel, the devices in the PLC connected to the text panel can be monitored.					

1.5.1 Arrangement of I/O Terminals

Specifications	Model	TP70P -32TP1R	TP70P -16TP1R	TP70P -22XA1R	TP70P -21EX1R	TP70P -RM0
Digital input terminal	X0~X7, X10~X17 (16 terminals)	X0~X7 (8 terminals)	X0~X7 (8 terminals)	X0~X7 (8 terminals)	X0~X7 (8 terminals)	--
Digital output terminal	Y0~Y7, Y10~Y17 (16 terminals)	Y0~Y7 (8 terminals)	Y0~Y7 (8 terminals)	Y0~Y7 (8 terminals)	Y0~Y7 (8 terminals)	--
Analog input terminal	--	--	--	Voltage/Current 4 channels (12-bit)	Current 2 channels (12-bit)	--
Analog output terminal	--	--	--	Voltage/Current 2 channels (12-bit)	Current 1 channel (12-bit)	--
Temperature input terminal (Pt100)	--	--	--	--	2 channels (16-bit)	--

1.5.2 Devices in a PLC

Item			Range			
Relay	Bit device	X	External input relay	X0~X7; X10~X17	(*4)	
		Y	External output relay	Y0~Y7; Y10~Y17		
	M	Auxiliary relay	General	M0~M511: 512 auxiliary relays (*1) M768~M999: 232 auxiliary relays (*1) M2000~M2047: 48 auxiliary relays (*1)	4096 auxiliary relays in total	
			Latching	M512~M767: 256 auxiliary relays (*2) M2048~M4095: 2048 auxiliary relays (*2)		
			Special	M1000~M1999: 1000 auxiliary relays Some of them are latching auxiliary relays		
	T	Timer	100 ms (If M1028 is On, T64~T126 will be 10 millisecond timers.)	T0~T126: 127 timers (*1) T128~T183: 56 timers (*1) T184~T199 (for subroutines): 16 timers (*1) T250~T255 (accumulation): 6 timers (*1)	256 timers in total	
				10 ms (If M1038 is On, T200~T245 will be 1 millisecond timers.)		T200~T239: 40 timers (*1) T240~T245 (accumulation), 6 timers (*1)
						1 ms
			C	Counter		16-bit up counter
	32-bit up/down counter	C200~C223: 24 counters (*1) C224~C232: 9 counters (*2) C233~C234: 2 counters (*2) C237~C250: 14 counters (*2) C252~C255: 3 counters (*2)				
32-bit high-speed up/down counter		C235, C236: 2 one-phase one-input counters (*2) C251: 1 two-phase two-input counter (*2)			3 counters in total	
	S	Stepping relay		Initialization	S0~S9: 10 stepping relays (*2)	1024 stepping relays in total
Returning to zero				S10~S19: 10 stepping relays (S10~S19 and the instruction IST are used together.) (*2)		
Latching			S20~S127: 108 stepping relays (*2)			
General			S128~S911: 784 stepping relays (*1)			
Alarm			S912~S1023: 112 stepping relays (*2)			
Register	Bit device	T	Present value in a timer	T0~T255: 256 timers		
		C	Present value in a counter	C0~C199: 200 16-bit counters C200~C254: 55 32-bit counters		
	D	Data register	General	D0~D407: 408 data registers (*1) D600~D999: 400 data registers (*1) D3920~D3999: 80 data registers (*1)	5000 data registers in total	
			Retentive	D408~D599: 192 data registers (*2) D2000~D3919: 1920 data registers (*2)		
			Special	D1000~D1999: 1000 data registers (Some of them are retentive data registers.) D4000~D4999: 1000 data registers (*2)		
			Index	E0~E7, F0~F7: 16 data registers (*1)		

1



Item			Range	
Pointer	N	Master control loop	N0~N7: 8 N devices	
	P	Pointer	P0~P255: 256 pointers	
	I	Interrupt	External interrupt	I000/I001(X0), I100/I101(X1) (01: Rising edge-triggered ; 00: Falling edge-triggered)
			Timer interrupt	I602~I699, I702~I799: 2 interrupts (Time base=1 ms)
			High-speed interrupt	I010: 1 interrupt
Communication interrupt			I150 (COM2): 1 interrupt (*3)	
Constant	K	Decimal system	K-32,768~K32,767 (16-bit operation) K-2,147,483,648~K2,147,483,647 (32-bit operation)	
	H	Hexadecimal system	H0000~HFFFF (16-bit operation) H00000000~HFFFFFFF (32-bit operation)	

Note:

*1: They are not latching/retentive devices. They can not be changed.

*2: They are latching/retentive devices. They can not be changed.

*3: Please refer to section 1.9 for more information.

*4: Please refer to section 1.5.1 for more information.

1.6 Electrical Specifications

1.6.1 Specifications for PLCs

Model	TP70P -16TP1R	TP70P -32TP1R	TP70P -22XA1R	TP70P -21EX1R	TP70P -RM0
Item					
CPU	32-bit ARM Cortex-M4 MCU				
Program memory	Flash ROM: 128 MB (OS: 30 MB/Backup: 16 MB/User AP: 82 MB)				
Internal memory	64 Mbytes				
Retentive memory	32 Kbytes				
Supply voltage	24 V DC (-15%~20%) (DC input power polarity reversal protection)				
Electric energy consumption	5W	5W	5W	5W	3W
Power protection	DC input power polarity reversal protection				
Insulation impedance	> 5 MΩ (The voltage between all I/O terminals and the ground is 500 V DC.)				
Noise immunity	ESD (IEC 61131-2, IEC 61000-4-2): 8 kV Air Discharge EFT (IEC 61131-2, IEC 61000-4-4): Power Line: 2 kV, Digital I/O: 1 kV, Analog & Communication I/O: 1 kV Damped-Oscillatory Wave: Power Line: 1 kV, Digital I/O: 1 kV RS (IEC 61131-2, IEC 61000-4-3): 26 MHz~1 GHz, 10 V/m				
Ground	The diameter of the ground used should not be less than the diameters of the wires connected to the power terminals of the PLC used. (If several PLCs are used simultaneously, please use single-point ground.)				
Battery	3 V CR2032 battery				
Battery lifespan	3 years at a temperature of 25°C				
Operating temperature	0°C~50°C Relative humidity: 20% - 90% RH 【0~40°C】 , 10%~55% RH 【41~50°C】 Pollution degree 2 (No condensation)				

Model	TP70P -16TP1R	TP70P -32TP1R	TP70P -22XA1R	TP70P -21EX1R	TP70P -RM0
Storage temperature	-20°C~60°C				
Vibration/Shock resistance	International standards IEC61131-2, IEC 68-2-6 (TEST Fc)/IEC61131-2 & IEC 68-2-27 (TEST Ea)				
Dimensions	175.8 × 108.6 × 59.2 mm (Width × Height × Depth)				
Cooling	Transfer of thermal energy via convection				

1.6.2 Electrical Specifications for Digital Input Terminals

Model	Electrical specifications for digital input terminals	
Item	24 V DC (-15% ~ 20%) single common terminal	
Input terminal	X0, X1	X2~X7, X10~X17
Input form	Sinking current: Current flows into the terminal S/S. Sourcing current: Current flows from the terminal S/S.	
Input voltage (±10%)	24 V DC, 5 mA	
Input impedance	4.7 kilohm	
Maximum input frequency	10 kHz	60 Hz
Action level	Off→On	> 16.5 V DC
	On→Off	< 8 V DC
Response time	Off→On	<20 us
	On→Off	<50 us

1.6.3 Electrical Specifications for Digital Output Terminals

Model	Electrical specifications for digital output terminals	
Output type	Relay	
Voltage	250 V AC, < 30 V DC	
Current	Resistance	1.5 A/point (5 A/COM)
	Inductance	#1
	Bulb	20 W DC/100 W AC
Response time	Off→On	Approximately 10 ms
	On→Off	
Maximum output frequency	50 Hz	

#1: Life curves

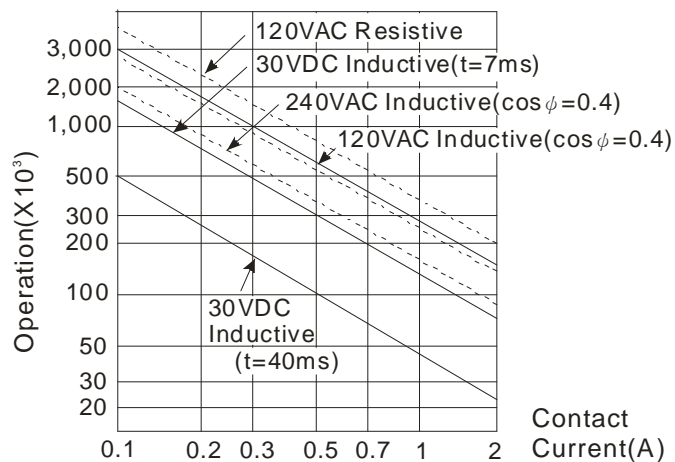



1.6.4 Electrical Specifications for Analog I/O Terminals

Electrical specifications for the analog I/O terminals on TP70P-22XA1R

Item	Model	Electrical specifications for the analog I/O terminals on TP70P-22XA1R			
		Voltage input	Current input	Voltage output	Current output
Analog input range		±10 V	±20 mA	--	--
Analog output range		--	--	±10 V	0~20 mA
Digital conversion range		±2000	±1000	±2000	0~4000
Resolution		12 bits (1 lsb=5 mV)	11 bits (1 lsb=20 uA)	12 bits (1 lsb=2.5 mV)	12 bits 1 lsb=5 uA
Input impedance		Above 200 kΩ	250 Ω	--	--
Output impedance		--	--	100 Ω	
Overall accuracy		If a signal reaches full scale at a temperature of 25°C (77°F), there will be an error in the range of ±0.5% If a signal reaches full scale at a temperature in the range of 0~55°C (32~131°F), there will be an error in the range of ±1%.			
Response time		3 ms/channel			
Isolation		No isolation			
Absolute input range		±15 V	±32 mA	--	--
Digital data type		16-bit two's complement There are 11 significant bits.			
Maximum output current (Allowable load)		--	--	10 mA (1 kΩ~2 MΩ)	0~500 Ω
Protection		--	--	The voltage output terminals are equipped with short circuit protection. (Please do not short-circuit the voltage output terminals for a long time, otherwise they may be burned.) The current output terminals can have open circuits.	

Electrical specifications for the analog I/O terminals on TP70P-21EX1R

Item	Model	Electrical specifications for the analog I/O terminals on TP70P-21EX1R		
		Current input	Current output	Temperature measurement
Sensor type		--	--	2-wire/3-wire Pt100
Driving current		--	--	1.6 mA
Analog input range		0~20 mA	--	-20°C~160°C
Analog output range		--	0~20 mA	--
Digital conversion range		0~2000	0~2000	-200~1600
Resolution		11 bits (1 lsb=10 uA)	12 bits (1 lsb=10 uA)	12 bits (0.1°C)
Input impedance		250 Ω	--	
Output impedance		--	100 Ω	
Overall accuracy		If a signal reaches full scale at a temperature of 25°C (77°F), there will be an error in the range of ±0.5%. If a signal reaches full scale at a temperature in the range of 0~55°C (32~131°F), there will be an error in the range of ±1%.		If a signal reaches full scale at a temperature in the range of 0~55°C (32~131°F), there will be an error in the range of ±1%.
Response time		3 ms/channel		300 ms × Quantity of channels
Isolation		No isolation		
Absolute input range		0~32 mA	--	--
Digital data type		16-bit two's complement There are 11 significant bits.		

Item	Model	Electrical specifications for the analog I/O terminals on TP70P-21EX1R		
		Current input	Current output	Temperature measurement
Maximum output current (Allowable load)		--	0~500 Ω	--
Protection		--	The current output terminals can have open circuits.	--

1

1.7 Installation

Please put (embed) TP70P into a control panel. Use the fasteners and the screws in the container in which TP70P is packaged. Insert the fasteners into the slots on TP70P, and then tighten the screws. (The torque applied to the screws should be 4.75 kg-cm. It can not exceed 4.75 kg-cm, otherwise the panel will be destroyed. If the fasteners are not used correctly, Delta does not guarantee a degree of resistance to water. Please see the figures below. The control panel should be watertight and dustproof, or meet corresponding specifications (IP66/NEMA 4).

Please do not install TP70P in the following environments.

- Environments in which there are dust, oily smoke, metal powder, and corrosive or flammable gas
- High-temperature and humid environments
- Environments in which TP70P may be shocked and vibrated directly

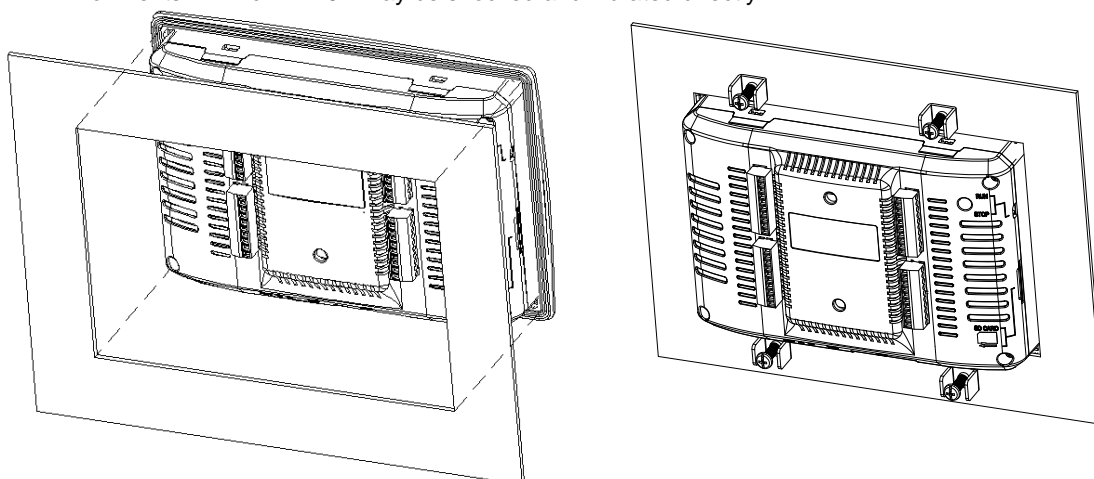

Wiring terminals

1. Please connect 22 to 16 AWG (1.5 mm) single-core or twin-core cables to the input/output terminals on TP70P.

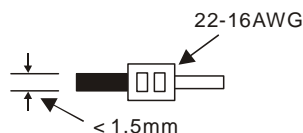

The torque applied to the screws on TP70P should be 1.90 kg-cm (1.65 in-lbs). Only copper leads which can resist the heat above 60°C/75°C can be used.

2. Please connect 22 to 12 AWG single-core or twin-core cables to the power input connector on TP70P. (Only copper leads which can resist the heat above 60°C/75°C can be used.) The torque applied to the screws on the PLC connected to TP70P should be in the range of 5~8 kg-cm (4.3~6.9lb-in).
3. Please do not wire the terminal •. Input cables and output cables should not be put in the same cable tray.
4. When users tighten screws and wire terminals, they should prevent tiny metallic conductors from dropping into TP70P. After the wiring of TP70P is complete, the users have to ensure that TP70P can radiate heat normally.

1

1.8 Wiring

1.8.1 Wiring a Power Input Connector

The power supplied to TP70P is DC power. When users use TP70P, they have to note the following points.

- Please connect wires to the terminals +24V and 0V. The power supplied to TP70P should be in the range of 20.4 V DC to 28.8 V DC. If the voltage of the power supplied to TP70P is less than 20.4 V DC, TP70P will stop running, and output devices will be off.
- If a power cut is shorter than 10 milliseconds, TP70P will not stop running. If a short cut is long, or the voltage of the power supplied to TP70P decreases, TP70P will stop running, and output devices will be off. If power is restored after a power cut, TP70P will automatically resume running. (There are latching auxiliary relays and retentive registers in TP70P. Users should use them carefully when they design a program.)
- The power supplied to TP70P is DC power. A Delta power supply module (DVPPS02/DVPPS05) can be used to supply power to TP70P. In order to protect DVPPS02/DVPPS05, users need to have the protection circuit shown below.

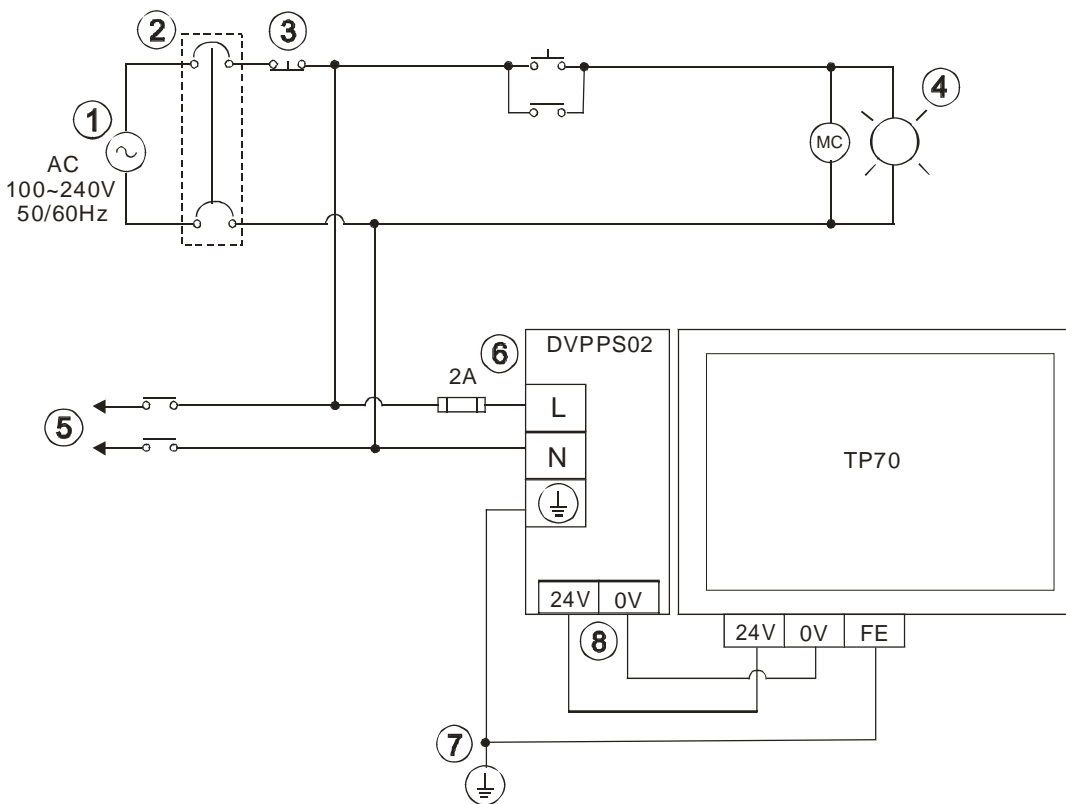

①	AC power supply: 100~240 V AC, 50/60 Hz
②	Circuit breaker
③	Emergency stop: An emergency stop button can be used to cut off power when an emergency occurs.
④	Power indicator
⑤	AC load
⑥	2 A fuse
⑦	Ground (Impedance: Less than 100 Ω)
⑧	DC power supply: 24 V DC

1.8.2 Wiring Input Terminals

The power supplied to input terminals are DC power. There are two types of current. They are sinking current and sourcing current.

- **Sinking current**

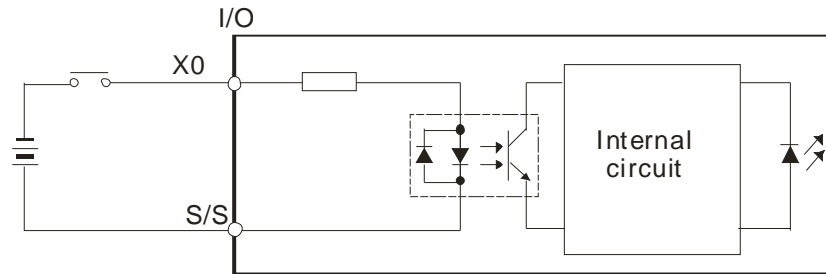

- **Sourcing current**

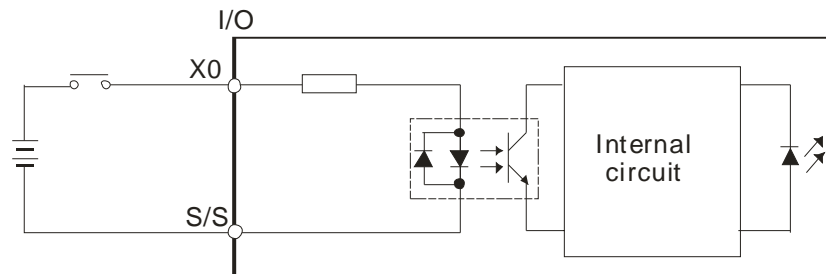

1.8.3 Wiring Relay Output Terminals

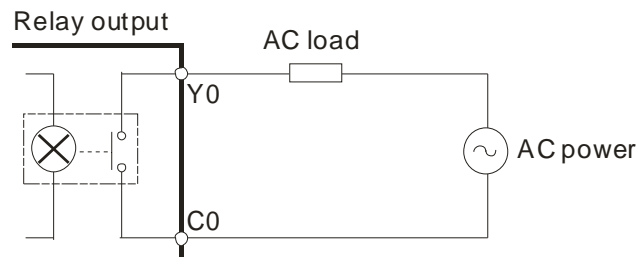



1.8.4 Wiring Analog Input Channels

● TP70P-22XA1R

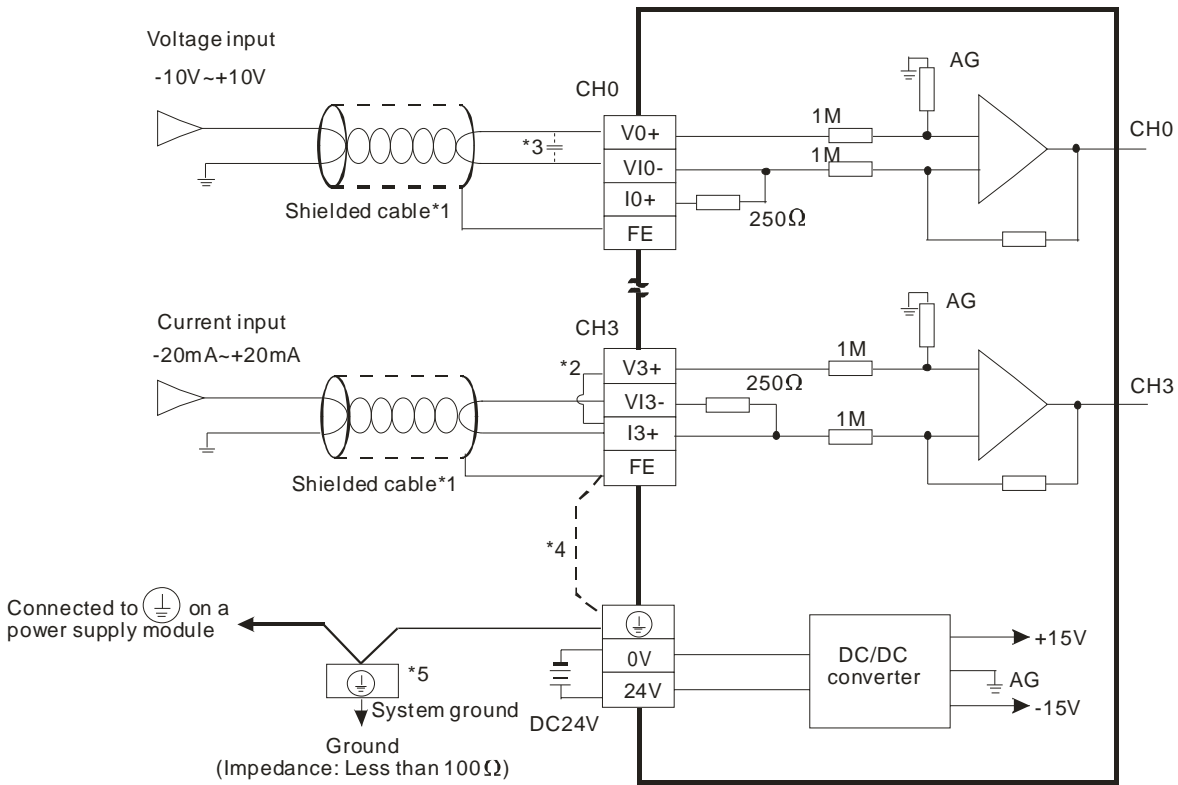

● TP70P-21EX1R

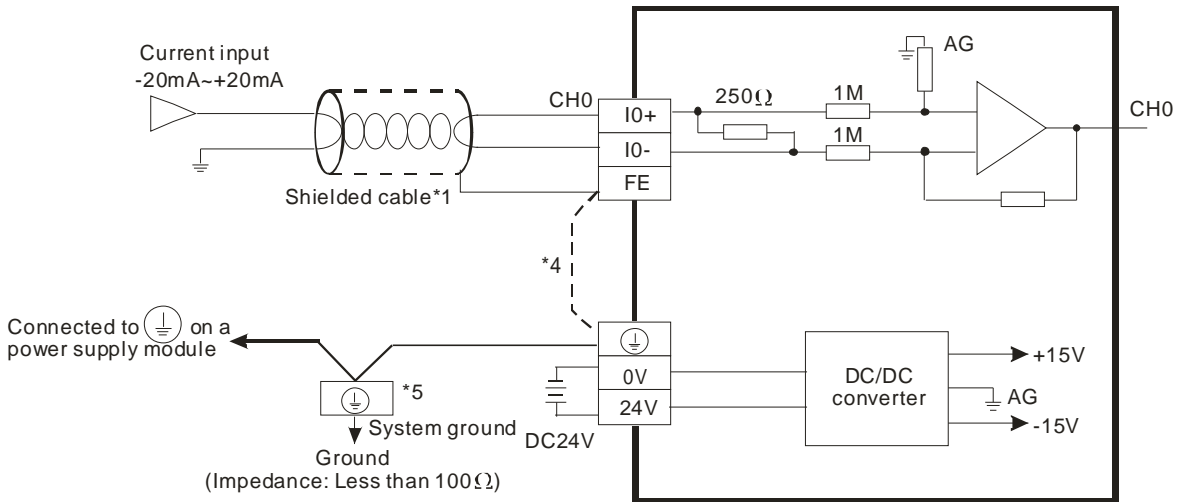

- *1: Please isolate analog input cables from other power cables.
- *2: If current is connected, the connection between V3+ and I3+ need to be a short circuit.
- *3: If ripple voltage results in interference with the wiring, please connect a 0.1~0.47 μF and 25 V capacitor.
- *4: If there is much noise, please connect the terminal FE to the ground terminal.
- *5: Please connect the ground terminal on a power supply module and the analog input terminal FE to the system ground, and then ground the system ground or connect the system ground to a distribution box.

1.8.5 Wiring Analog Output Channels

● TP70P-22XA1R

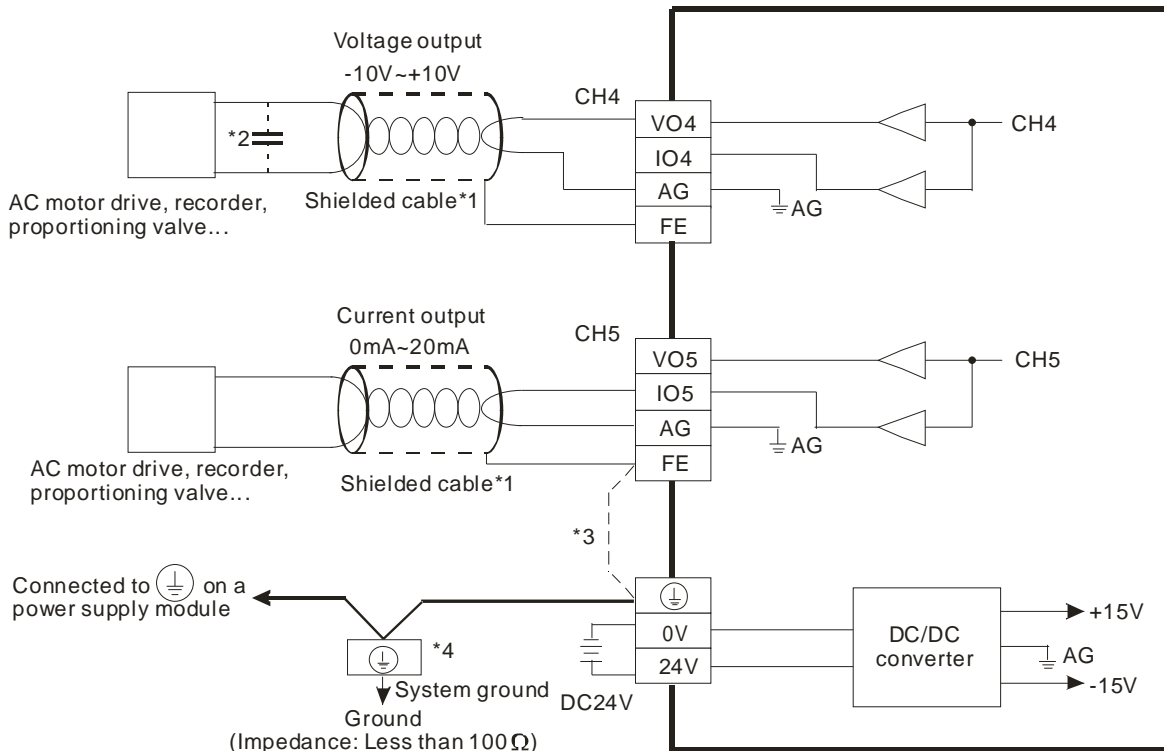

● TP70P-21EX1R

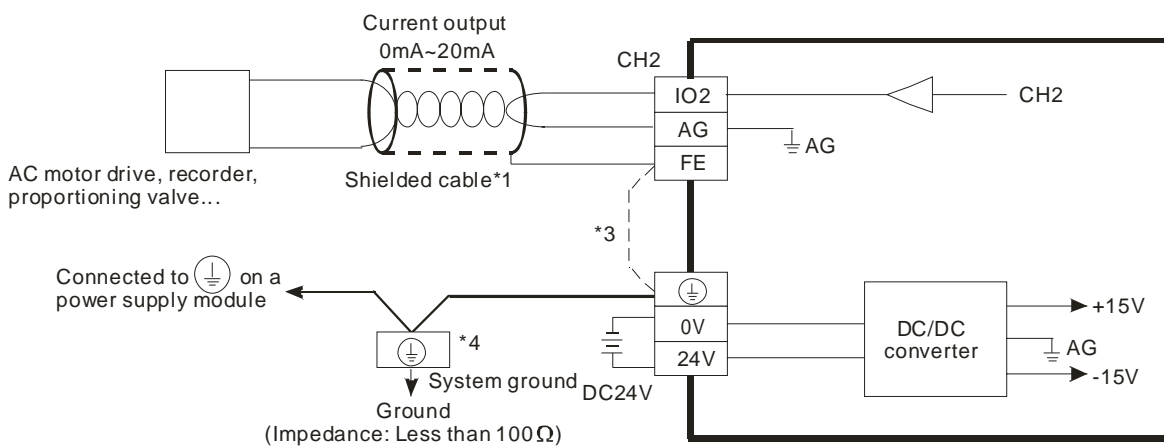

- *1: Please isolate analog output cables from other power cables.
- *2: If the ripple voltage of the input terminal of the load connected is large, and results in interference with the wiring, please connect a 0.1~0.47 μF and 25 V capacitor.
- *3: If there is much noise, please connect the terminal FE to the ground terminal.
- *4: Please connect the ground terminal on a power supply module and the analog output terminal FE to the system ground, and then ground the system ground or connect the system ground to a distribution box.



1.8.6 Wiring Temperature Measurement Input Terminals

● TP70P-21EX1R

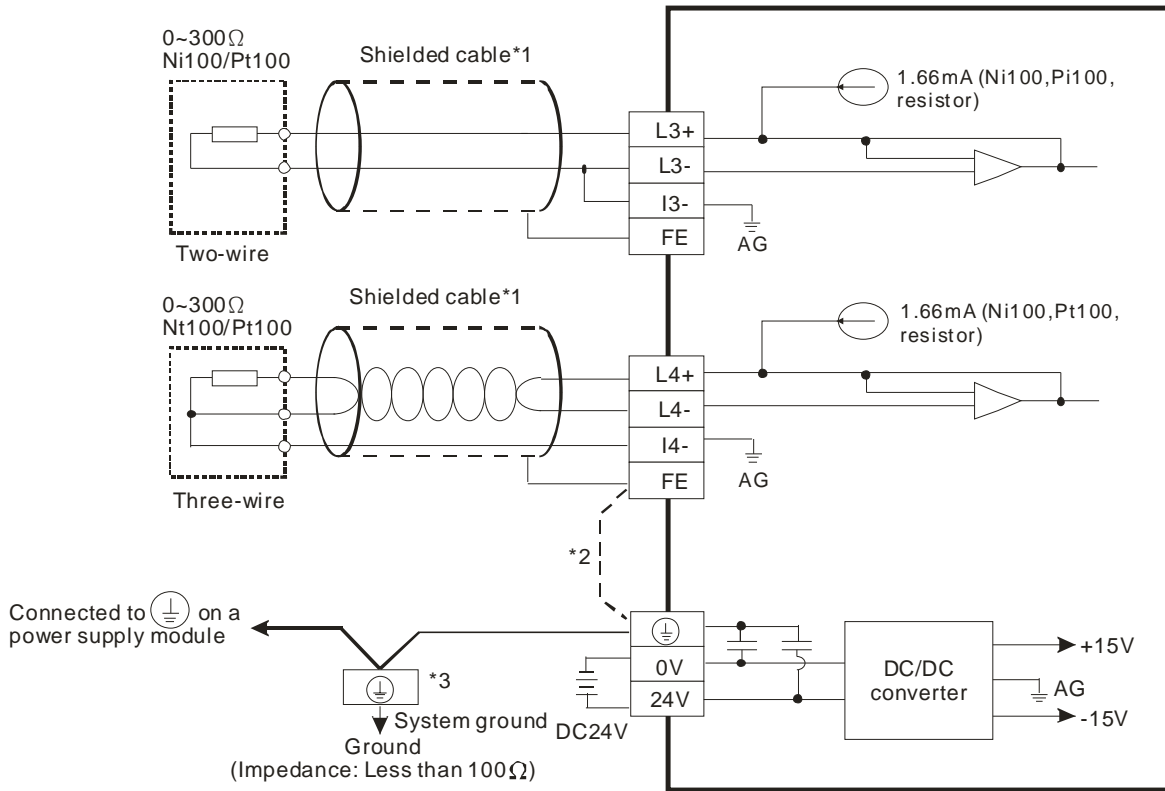

- *1: The cables connected to the input terminals should be cables or shielded twisted pair cables which can be connected to temperature sensors, and should be kept separate from other power cables and cables which may generate noise.
- *2: If there is much noise, please connect the terminal FE to the ground terminal.
- *3: Please connect FE on a power supply module and the temperature measurement input terminal FE to the system ground, and then ground the system ground or connect the system ground to a distribution box.
- *4: Please do not wire the terminal ●.

1.9 Definitions of the Pins in Communication Ports

● TP70P-16TP1R, TP70P-21EX1R, TP70P-22XA1R, TP70P-32TP1R

Pin	RS-485 (COM2)	RS-485 (COM3)
5	GND	GND
6	D+	N/C
7	D-	N/C
8	N/C	D+
9	N/C	D-

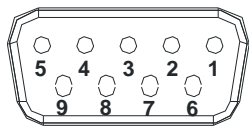

● TP70P-RM0

Pin	RS-232 (COM2)	RS-485 (COM3)
1	N/C	N/C
2	RX	N/C
3	TX	N/C
4	N/C	N/C
5	GND	GND
6	N/C	D+
7	N/C	D-
8	N/C	N/C
9	N/C	N/C

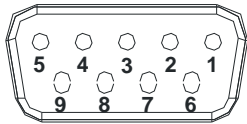



1.10 Controllers Supporting TP70P

Controllers supporting TP70P
Delta servers, Delta AC motor drives, Delta temperature controllers, and Delta PLCs

Wiring:

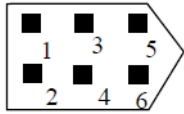
● Delta server

TP70P COM3 (RS-485)	Controller Male CN3 connector (RS-485)	Controller Pins in a male CN3 connector
RS-485+ (8)	(3)485+	
RS-485- (9)	(5)485+	
GND (5)	(4)485- (6)485- GND(1)	

● Delta AC motor drive

TP70P COM3 (RS-485)	Controller RJ11 connector (RS-485)	Controller Pins in an RJ11 connector
RS-485+ (8)	SG+(4)	
RS-485- (9)	SG-(3)	
GND (5)	GND(1)	

● Delta temperature controller

TP70P COM3 (RS-485)	Controller RS-485
RS-485+ (8)	D+(10)
RS-485- (9)	D-(9)

1

● Delta PLC

TP70P COM3 (RS-485)	Controller RS-485
RS-485+ (8)	D+
RS-485- (9)	D-

2

Chapter 2 Writing Programs



Table of Contents

2.1	Preparations.....	2-2
2.1.1	Hardware.....	2-2
2.1.2	Software.....	2-2
2.1.3	Tools and Materials.....	2-2
2.2	Wiring.....	2-2
2.2.1	Wiring Diagram for a Delta VFD-M Series AC Motor Drive.....	2-3
2.2.2	Wiring Diagram for External Terminals.....	2-3
2.2.3	Wiring Diagram for Communication.....	2-3
2.2.4	Setting Parameteres in a Delta VFD-M Series AC Motor Drive.....	2-4
2.3	Example.....	2-4
2.4	Writing a Program for a Text Panel.....	2-5
2.4.1	Planning Objects.....	2-7
2.4.2	Managing Pages.....	2-7
2.4.3	Creating Objects.....	2-8
2.4.4	Basic Configuration.....	2-15
2.4.5	Compile and Downloading a Program.....	2-16
2.5	Writing a Program for a PLC.....	2-18
2.5.1	Planning a Program.....	2-20
2.5.2	Control Program.....	2-21
2.5.3	Compile and Downloading a Program.....	2-22
2.6	Monitoring and Debugging a Program.....	2-23
2.6.1	Monitoring a Program.....	2-23
2.6.2	Removing System Errors.....	2-27

2.1 Preparations

2.1.1 Hardware

The hardware required is list below.

1. TP70P-16TP1R	2. Power supply module DVPPS02	3. VFD-M series AC motor drive
		

2

2.1.2 Software

The software required is listed below.

- WPLSoft version 2.36 or above
- TPEditor version 1.9 or above

2.1.3 Tools and Materials

The tools and the materials which are required are list below.

- One personal computer (The software mentioned above has been installed.)
- One 100~240 V AC and 50/60 Hz power supply
- One coil of wire
- One screwdriver
- One USB cable (Pleae refer to section 3.1 for more information about installing a USB driver.)

2.2 Wiring

After users install a text panel, they can wire the text panel. In order to ensure that the users can write programs smoothly, the users need to at least connect power cables. Please connect power cables to a text panel when the text panel is disconnected. The structure required is like the one shown below.



2.2.1 Wiring Diagram for a Delta VFD-M Series AC Motor Drive

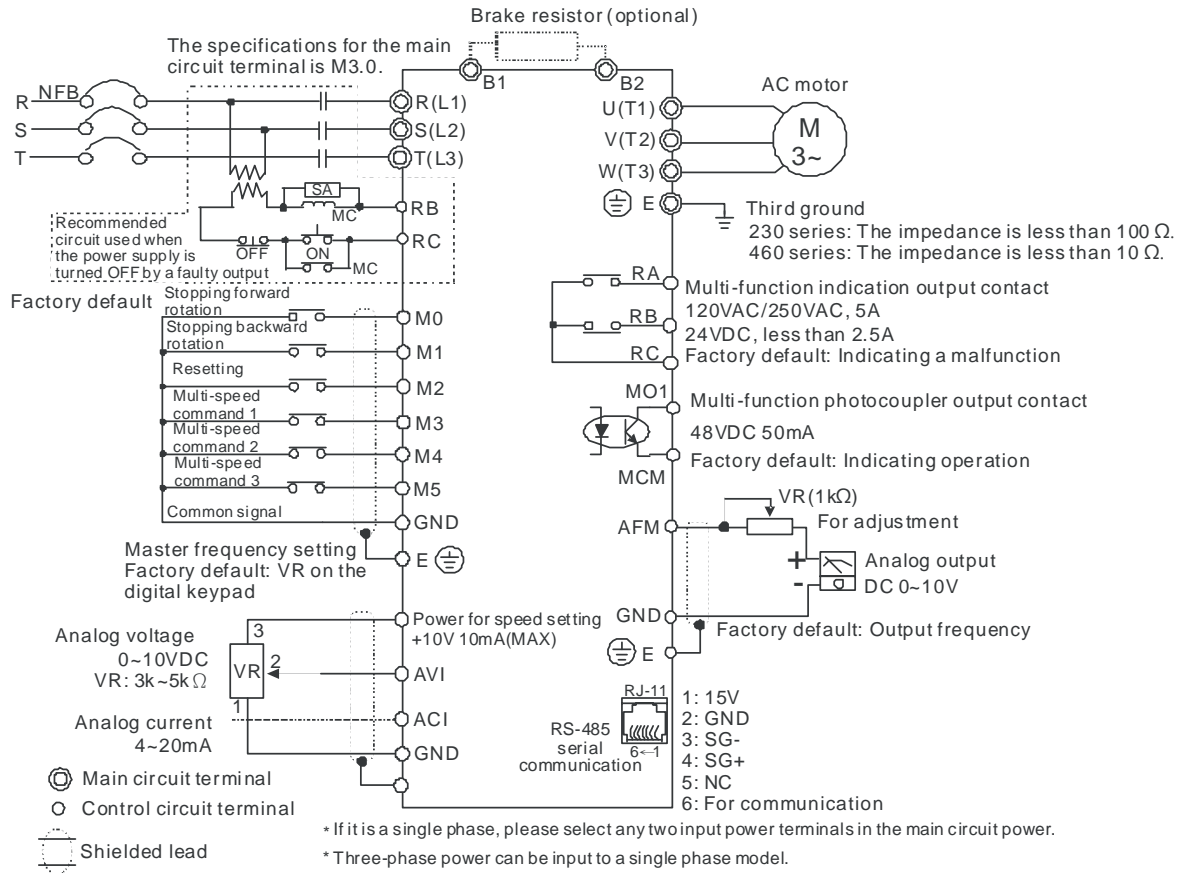

2

※ Please refer to VFD-M User Manual for more information.

2.2.2 Wiring Diagram for External Terminals

TP70P series text panel External I/O connector	VFD-M series AC motor drive
C0	GND
Y0	M0
Y1	M1

2.2.3 Wiring Diagram for Communication

TP70P COM3 (RS-485)	Controller RJ11 connector (RS-485)	Controller Pins in an RJ11 connector
RS-485+ (8)	SG+(4)	 <p>1~6</p>
RS-485- (9)	SG-(3)	
GND (5)	GND(1)	

2

2.2.4 Setting Parameters in a Delta VFD-M Series AC Motor Drive

Parameter	Setting	Description
P00	03	A master frequency is determined by an RS-485 port.
P01	01	Operation is controlled by external terminals. STOP on a keypad is effective.
P03	60	Maximum operating frequency (50.00~400.0 Hz)
P08	1.50	Minimum output frequency (0.10~20.00 Hz)
P88	01	The communication address of the VFD-M series AC motor drive is 1.
P89	01	Baud rate: 9600 bps
P92	01	MODBUS ASCII mode Data format: <7, E, 1>

※ If an AC motor drive can not operate normally due to the fact that parameters are not set correctly, users can set P76 to 10 (restore all parameters to the default value 60 Hz), and then set other parameters according to the table above.

2.3 Example

After users install, wire and power up hardware, they can prepare to write programs. In order to make the users have a specific target and a specific direction before they begin to write programs, the manual provides a common example for the users. The complete procedure which starts with the creation of a new project and ends with the downloading of the project to a PLC is described step by step.

- **Structure of a system**

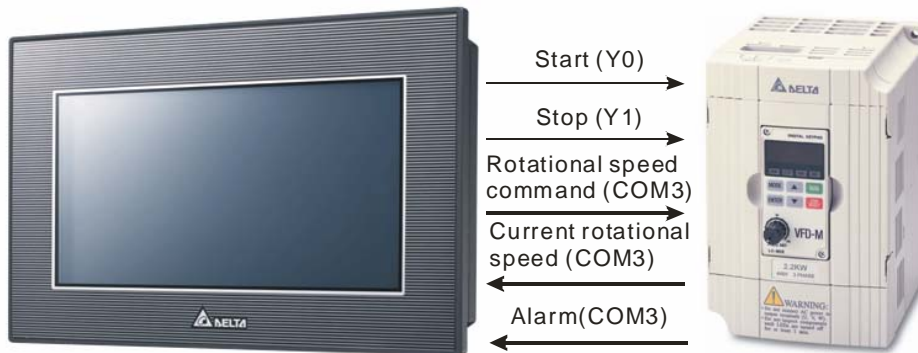

- **Control**

The communication between a PLC and a Delta VFD-M series AC motor drive is described here. Y devices on TP70P are used to control the forward/backward rotation of the AC motor drive. RS-485 communication (COM3) is used to read/set the frequency of signals output by the VFD-M series AC motor drive. If the AC motor drive breaks down, an alarm signal in the AC motor drive will be sent to TP70P.

Actions:

1. If the AC motor drive rotates forwards, its forward rotation indicator will be on, and the input which makes the the AC motor drive rotate barckwards will be ineffective.
2. If the AC motor drive rotates backwards, its backward rotation indicator will be on, and the input which makes the the AC motor drive rotate forwards will be ineffective.
3. If stop control is input, the operation of the AC motor drive will stop, and its stop indicator will be on.
4. The users can input a frequency range. The frequency range that the users set should be between the maximum operaring frequency of the AC motor drive and the minimum operaring frequency of the AC motor drive.
5. If the AC motor drive sends an error code, the operation of the AC motor drive will stop.

I/O devices in the PLC:

1. Forward rotation control (M0)
2. Backward rotation control (M1)
3. Stop control (M2)
4. Forward rotation switch (Y0)

5. Backward rotation swithc (Y1)
6. Stop indicator (M3)

Objects displayed on TP70P:

1. Forward rotation control
2. Backward rotation control
3. Stop control
4. Rotational speed input
5. Forward rotation indicator
6. Backward rotation indicator
7. Stop indicator
8. Current rotational speed
9. Warning message

2

2.4 Writing a Program for a Text Panel

The writing of a program for a text panel is described in this section. Please refer to TPEditor User Manual for more infomraiton about the functions of TPEditor.

Step 1: Start TPEditor. (**Start**→**Programs**→**Delta Industrial Automation**→**PLC**→**TPEditor x.xx**→**TPEditor x.xx**)

Welcom screen

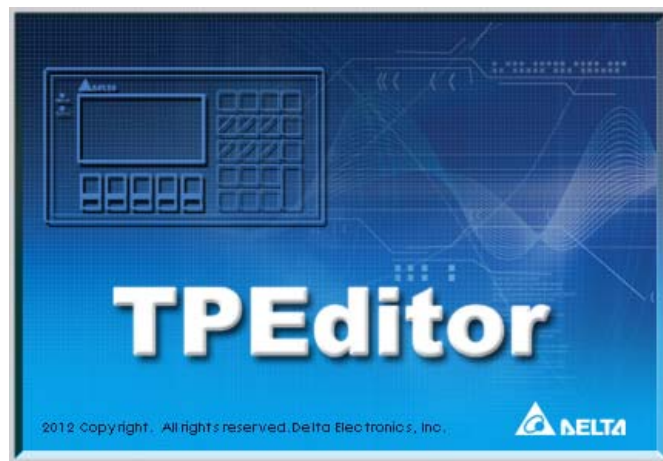

Main screen

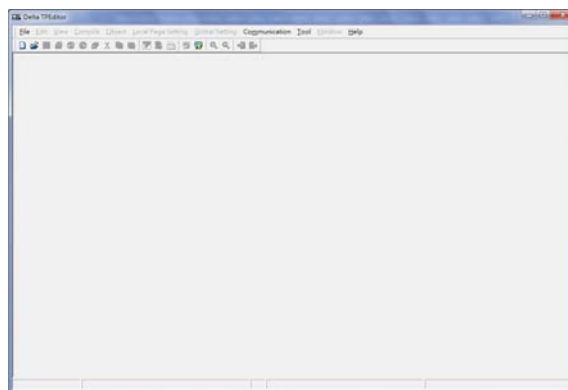

Step 2: After  on the standard toolbar is clicked, a new project will be added. In the **New Project** window, select **DELTA VFD Inverter** in the **HMI<=>PLC** section, select **TP70P** in the **TP Type** drop-down list box, and type "TP70-VFD CTRL" in the **File Name** box.

2

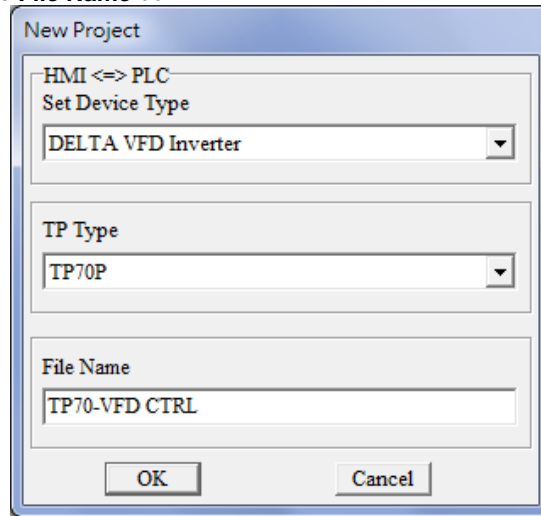

After **OK** in the **New Project** window is clicked, a project environment will be displayed.

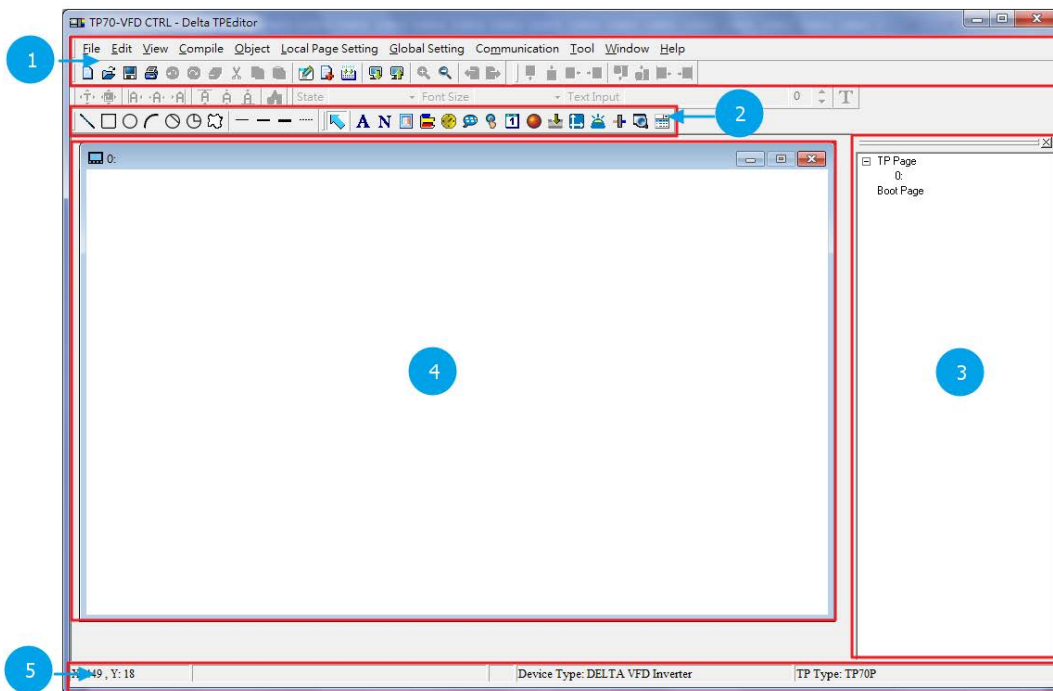

The interface of TPEditor is described below. Please refer to TPEditor User Manual for more information.

- ❶ Menu bar, standard toolbar, and object arrangement toolbar: The main functions of TPEditor are included. The functions which are used more frequently are on the standard toolbar, and the functions which are used less frequently are on the menu bar.
- ❷ Geometric object toolbar and object toolbar: They provide buttons used for drawing figures and creating buttons. There are some other objects on the **Object** menu.
- ❸ Page management area: Users can view/add/delete pages.
- ❹ Working area: Users can edit pages in this area.
- ❺ Status bar: The information about the current project and communication is displayed here.

2.4.1 Planning Objects

After users make sure of system requirements, they can plan messages which need to be displayed. The objects and the pages which need to be planned for the example in this chapter are described below.

Planning objects

- Forward rotation control→A button is used. After users press the button, the AC motor drive connected will rotate forwards.
- Backward rotation control→A button is used. After users press the button, the AC motor drive connected will rotate backwards.
- Forward rotation indicator→A multi-state image is used. If the AC motor drive connected rotates forwards, a green indicator will be on, and a message saying that the AC motor drive rotates forwards will appear.
- Backward rotation indicator→A multi-state image is used. If the AC motor drive connected rotates backwards, a yellow indicator will be on, and a message saying that the AC motor drive rotates backwards will appear.
- Stop indicator→A multi-state image is used. If the AC motor drive connected stops running, a red indicator will be on, and a message saying that the AC motor drive stops running will appear.
- Current rotational speed→A numeric display is used. The current rotational speed of the AC motor drive connected can be read by means of RS-485 communication.
- Error message→A message display is used. The state of the AC motor drive connected can be monitored by means of RS-485communication. If an error code in the AC motor drive connected is read, the error message corresponding to the error code will be displayed on the text panel used.
- Rotational speed input→A numeric input is used. A frequency can be written to the AC motor drive connected by means of RS-485 communication. If a minimum value and a maximum value are typed in the **Limit Setting** section, users can be prevented from setting a frequency which is not in the range of the minimum operating frequency of the AC motor drive connected to the maximum operating frequency of the AC motor drive connected.

Planning pages

- Plan a boot page on which the connection between TP70P and a VFD-M series AC motor drive is displayed.
- The state of the AC motor drive used is displayed on page 0, that is, the current rotational speed of the AC motor drive, a warning message, forward rotation control, backward rotation control, and stop control are displayed on page 0.

2.4.2 Managing Pages

Adding a page

Users have to add to two pages first. After the users right-click **TP Page** in the page management area, and click **Add** on the context menu which appears, a page will be added.

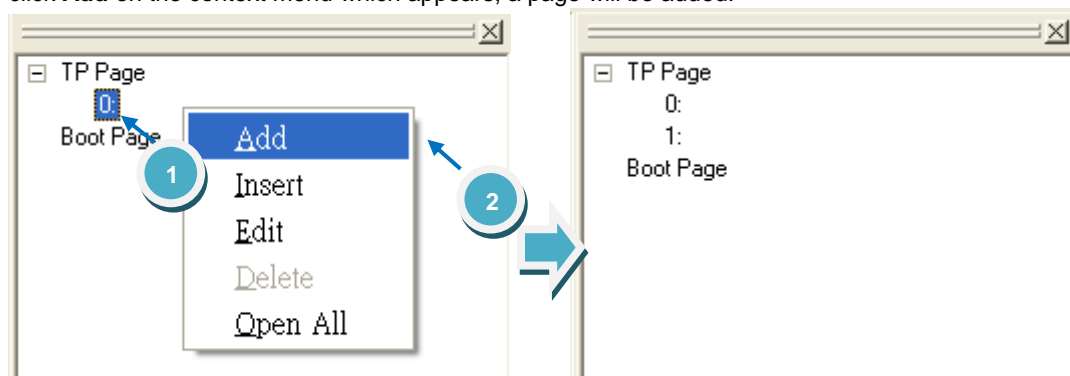

Editing the title of a page



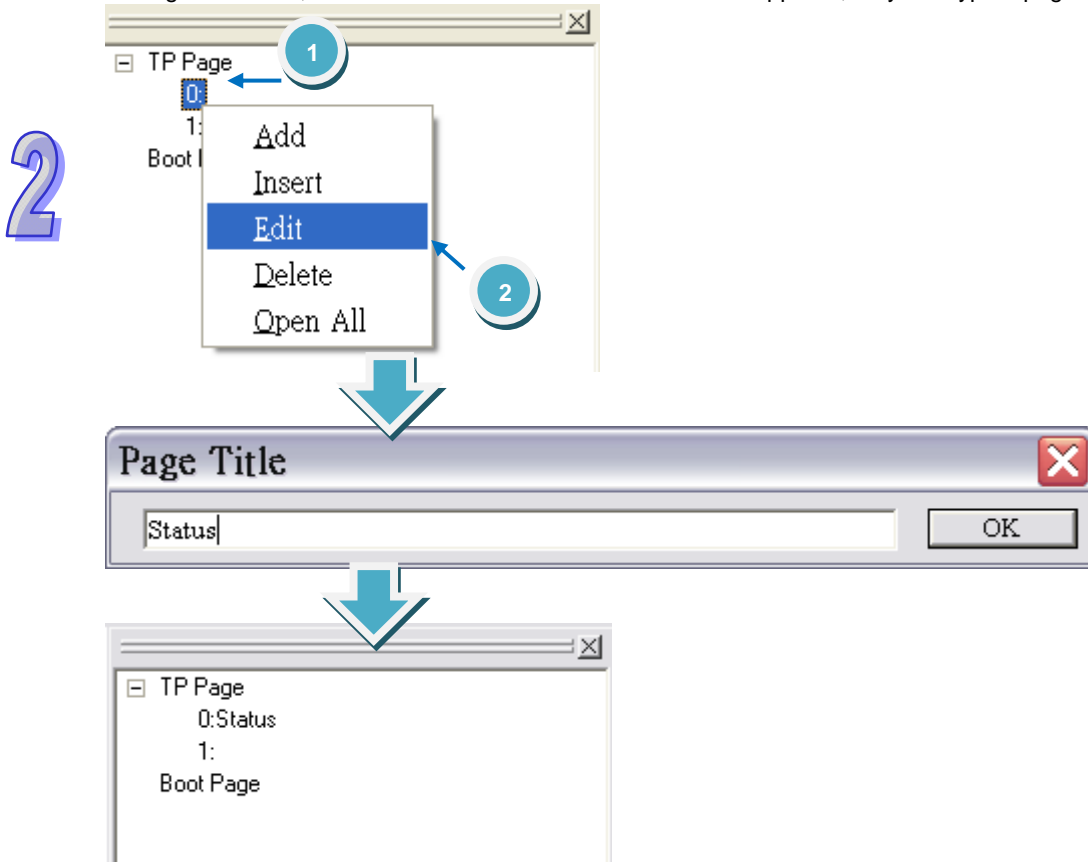





The users have to give names to the two pages. After the users right-click a page number in the page management area, and click Edit on the context menu which appears, they can type a page title.









2.4.3 Creating Objects

After users click an object on the object toolbar, they can click where they want to begin the selection of an area in the working area, hold down the left mouse button, and drag the cross over the area that they want to select. After the users double-click the object in the working area, the window used for setting the object will be opened.

The objects on the object toolbar are described below. Please refer to TPEditor User Manual for more information.

- **Static Bitmap** (): The files that TP70P supports are .gif files. The resolution of TP70P is 480x800 pixels. If the size of an image exceeds the resolution, the part which is left will not be displayed.
- **Static Text** (): Text is displayed.
- **Numeric/ASCII Display** (): The value in a related device is read, and displayed on the screen of TP70P.
- **Bar Graph** (): The value in a related device is read, and represented by a bar according to the target value, the maximum value, and the minimum value which are set.
- **Circle Meter** (): The value in a related device can be represented by the number to which the pointer on the dial of a meter points. The upper limit set can be differentiated from the lower limit set by means of the region colors set.
- **Message Display** (): The state of a related device or the value in a related device can be represented by a message displayed on the screen of TP70P.
- **Button** (): After users press a button, the state of the device related to the button will be changed, or a function can be set, e.g. the page selected will be displayed or passwords can be set.
- **RTC Display** (): The time on the real-time clock in TP70P is displayed on the screen of TP70P, or the time in related devices will be read and displayed on the screen of TP70P.

- **Multi-State Bitmap/Lable** (): The function of a multi-state image is the same as that of a dynamic image. The difference between a multi-state image and a dynamic image is that text can be inserted in a multi-state image.
- **Numeric Input** (): A numeric input displayed on the screen of TP70P is used to write a value to a related device.
- **X-Y Curve** (): The values in related devices can be represented by an X-Y curve displayed on the screen of TP70P.
- **Alarm** (): An alarm and a system alarm are used together. If a condition set is met, an alarm will appear.
- **Slider** (): Users can write a value to a related device by move the indicator on a slider displayed on TP70P.

The users have to plan pages and add object. They have to add an image representing the connection between TP70P and an AC motor drive to the boot page. They need to click  on the object toolbar, click where they want to begin the selection of an area in the working area, hold down the left mouse button, and drag the cross over the area that they want to select. After the users double-click the object in the working area, an **Open** window will appear. After the users select a .gif file, an image will appear in the working area.

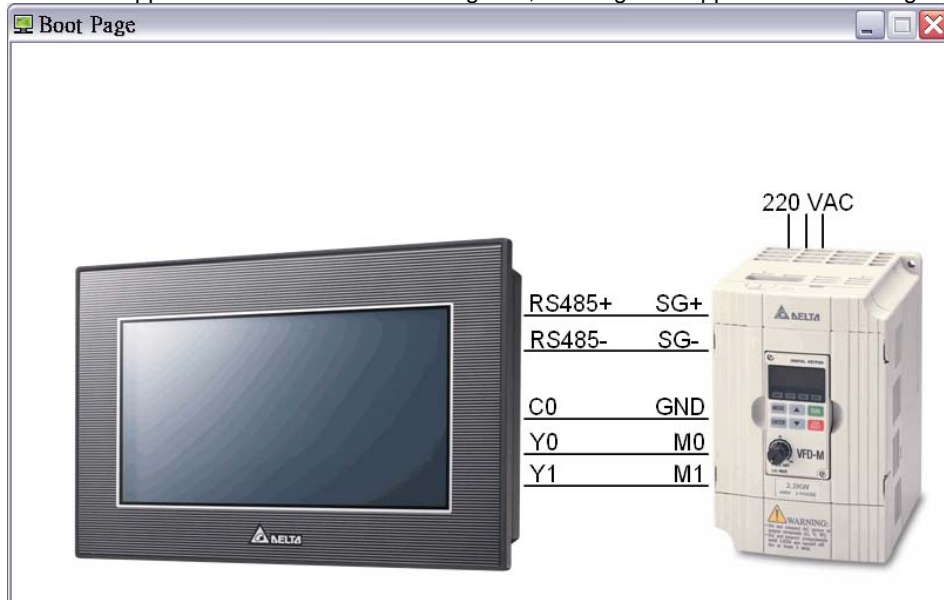

The state of the AC motor drive used is displayed on page 0, that is, the current rotational speed of the AC motor drive, a warning message, forward rotation control, backward rotation control, and stop control are displayed on page 0.

If the users want to add an object to a page, they have to click an object type on the object toolbar, click where they want to begin the selection of an area in the working area, hold down the left mouse button, and drag the cross over the area that they want to select.

2

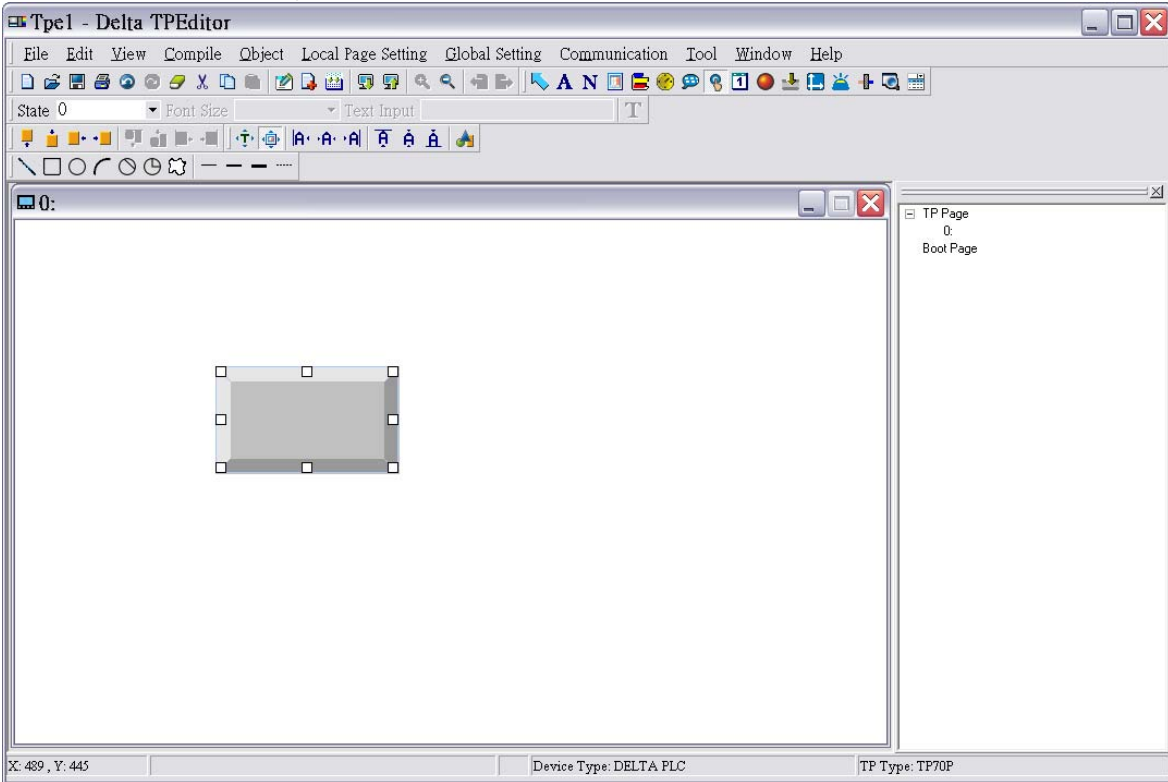

After the users add an object, they have to set the parameters related to be object. After users double-click a button in the working area, the **Button Setting** window will appear. In the example in this chapter, Y0 in TP70P is used to control the forward rotation of an AC motor drive. If a button is pressed, M0 will be ON. If M0 is ON, Y0 will be ON. If the button is pressed again, M0 will be OFF. Consequently, the button type selected in the **Button Type** drop-down list box is **Push On/Off**, and the **Internal PLC Setting** option button and M0 in the **Refer Device** window are selected.

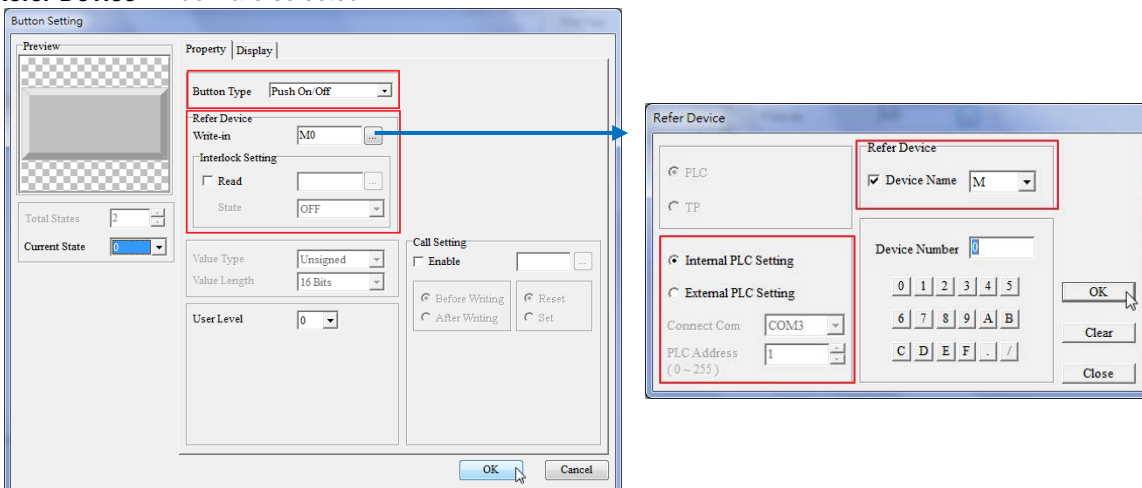

After the users click the **Property** tab in the window used to set the parameters of an object, they can set the appearance of the object. After the users click the **Property** tab in the **Button Setting** window, they can select a value in the a **Border Width** box, select colors in the **Button Event Color Setting** section, and type text or select an image in the **States** section. The text displayed on a button varies with the current state of the button. In the example in this chapter, “FORWARD” need to be displayed on the forward rotation control button created if the forward roation control button is not pressed yet, and “Running...” need to be displayed on the rotation control button created if the forward roation control button is pressed. Consequently, the users have to type “FORWARD” in the **Button Text** when **0** in the **Current State** drop-down list box is selected, and they have to type “Running” in the **Button Text** when **1** in the **Current State** drop-down list box is selected. After the users click **OK** in the **Button Setting** window, the setting of the parameters and the appearance of the button created will be complete.

2

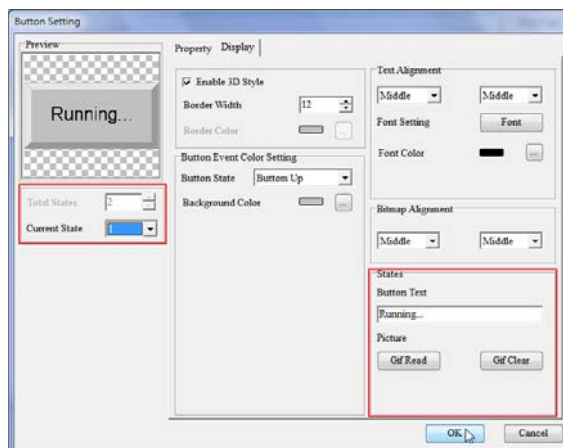
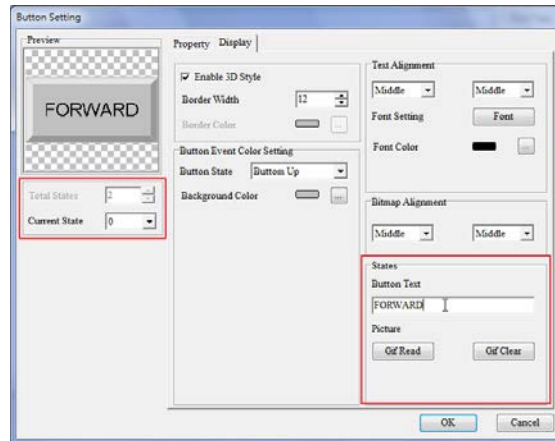

If the users want to make a copy of an object in the working area, they have to click the object, right-click the object, click **Copy** on the context menu which appears, right-click the object, and click **Paste** on the context menu which appears. If the users want to make several copies of an object in the working area, they have to click the object, right-click the object, click **Multi-Copy...** on the context menu which appears, select checkboxes, values or an option button in the **Multi-Copy** window, and click **OK**.

2

Singe copy:

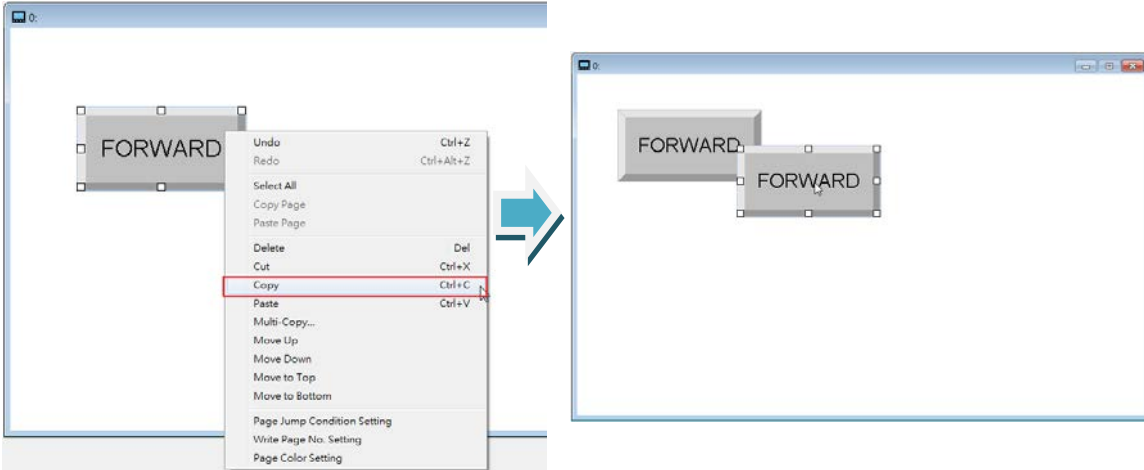

Multiple copies:

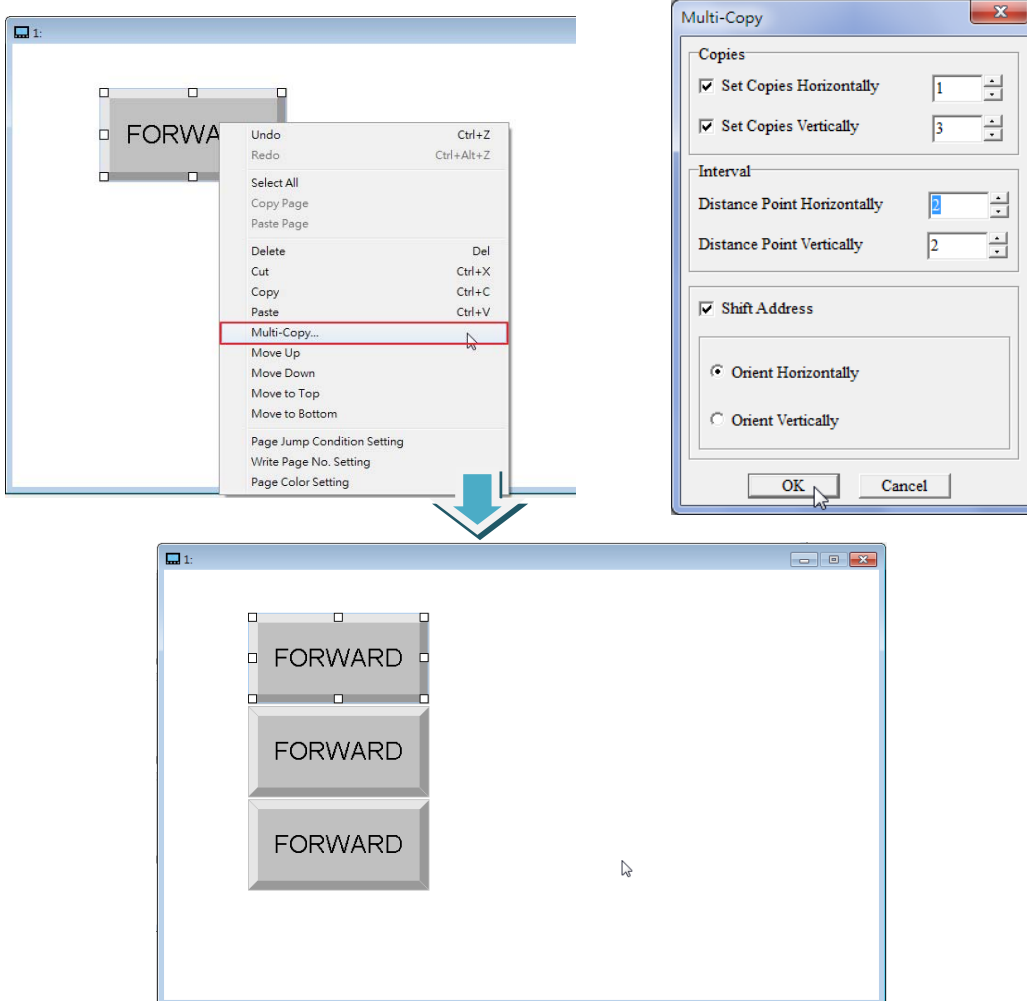

The users can complete the page shown below in the way described above.

The screenshot shows a window titled '0:' containing three buttons labeled 'FOWARD', 'REVERSE', and 'STOP'. To the right of these buttons are four input fields:

- Status:** Three buttons, each labeled 'FORWARD'.
- Freq. Setting:** A text input field with a red border containing '#####'.
- Current Freq.:** A text input field containing '0'.
- Err MSG:** A text input field containing '0'.

2

Setting the parameters of objects:

Item	Object description	Button/Object type	Related device		Other settings
			Communication method	Device address	
1	Forward rotation control	Push On/Off	Internal PLC	M0	-
2	Backward rotation control	Push On/Off	Internal PLC	M1	-
3	Stop control	Momentary	Internal PLC	M2	-
4	Forward rotation indicator	Multi-State Bitmap/Lable	Internal PLC	Y0	Background color (1/0): Green/White
5	Backward rotation indicator	Multi-State Bitmap/Lable	Internal PLC	Y1	Background color (1/0): Yellow/White
6	Stop indicator	Multi-State Bitmap/Lable	Internal PLC	M3	Background color (1/0): Red/White
7	Rotational speed input	Numeric Input	COM3, station address 1	\$2001	In the Value Setting section: Integer Number: 3 Decimal Number: 2 In the Limit Setting section: Max Value: 600 Min Value: 15
8	Current rotational speed	Numeric/ASC II Display	COM3, station address 1	\$2102	-

2

Item	Object description	Button/Object type	Related device		Other settings																																										
			Communication method	Device address																																											
9	Error message	Message Display	COM3, station address 1	\$2100	<p>Total States: 21 Display Sequence: From Min to Max Current State (Device Value>=Range Value): Please refer to the table below.</p> <table border="1"> <tr><td>0</td><td>No error occurs.</td></tr> <tr><td>1</td><td>Overcurrent</td></tr> <tr><td>2</td><td>Overvoltage</td></tr> <tr><td>3</td><td>Overheating</td></tr> <tr><td>4</td><td>The drive is overloaded.</td></tr> <tr><td>5</td><td>The motor is overloaded.</td></tr> <tr><td>6</td><td>External fault</td></tr> <tr><td>7</td><td>CPU failure</td></tr> <tr><td>8</td><td>CPU failure or analog circuit failure</td></tr> <tr><td>9</td><td>Hardware protection failure</td></tr> <tr><td>10</td><td>There is overcurrent during the acceleration.</td></tr> <tr><td>11</td><td>There is overcurrent during the deceleration.</td></tr> <tr><td>12</td><td>There is overcurrent during the steady operation.</td></tr> <tr><td>13</td><td>Ground fault</td></tr> <tr><td>14</td><td>Low voltage</td></tr> <tr><td>15</td><td>Reserved</td></tr> <tr><td>16</td><td>CPU failure</td></tr> <tr><td>17</td><td>Base block</td></tr> <tr><td>18</td><td>Overload</td></tr> <tr><td>19</td><td>Automatic acceleration/deceleration failure</td></tr> <tr><td>20</td><td>The software protection is enabled.</td></tr> </table>	0	No error occurs.	1	Overcurrent	2	Overvoltage	3	Overheating	4	The drive is overloaded.	5	The motor is overloaded.	6	External fault	7	CPU failure	8	CPU failure or analog circuit failure	9	Hardware protection failure	10	There is overcurrent during the acceleration.	11	There is overcurrent during the deceleration.	12	There is overcurrent during the steady operation.	13	Ground fault	14	Low voltage	15	Reserved	16	CPU failure	17	Base block	18	Overload	19	Automatic acceleration/deceleration failure	20	The software protection is enabled.
0	No error occurs.																																														
1	Overcurrent																																														
2	Overvoltage																																														
3	Overheating																																														
4	The drive is overloaded.																																														
5	The motor is overloaded.																																														
6	External fault																																														
7	CPU failure																																														
8	CPU failure or analog circuit failure																																														
9	Hardware protection failure																																														
10	There is overcurrent during the acceleration.																																														
11	There is overcurrent during the deceleration.																																														
12	There is overcurrent during the steady operation.																																														
13	Ground fault																																														
14	Low voltage																																														
15	Reserved																																														
16	CPU failure																																														
17	Base block																																														
18	Overload																																														
19	Automatic acceleration/deceleration failure																																														
20	The software protection is enabled.																																														

2.4.4 Basic Configuration

After users click **Basic Configuration** on the **Tool** menu, they can click **PC <=> TP Communication Setting**, **TP <=> PLC Protocol**, or **TP Other Setting** in the **Basic Configuration** window.

PC <=> TP Communication Setting

Before users download the program in TPEditor to a text panel, or upload the program in a text panel to their personal computer, they have to click **PC <=> TP Communication Setting** in the **Basic Configuration** window. The users have to use a USB cable to connect the text panel to the personal computer. The communication ports on the personal computer are displayed in TPEditor. After the users select the communication port which is connected to the text panel, they can download the program in TPEditor to the text panel, or upload the program in the text panel to the personal computer.

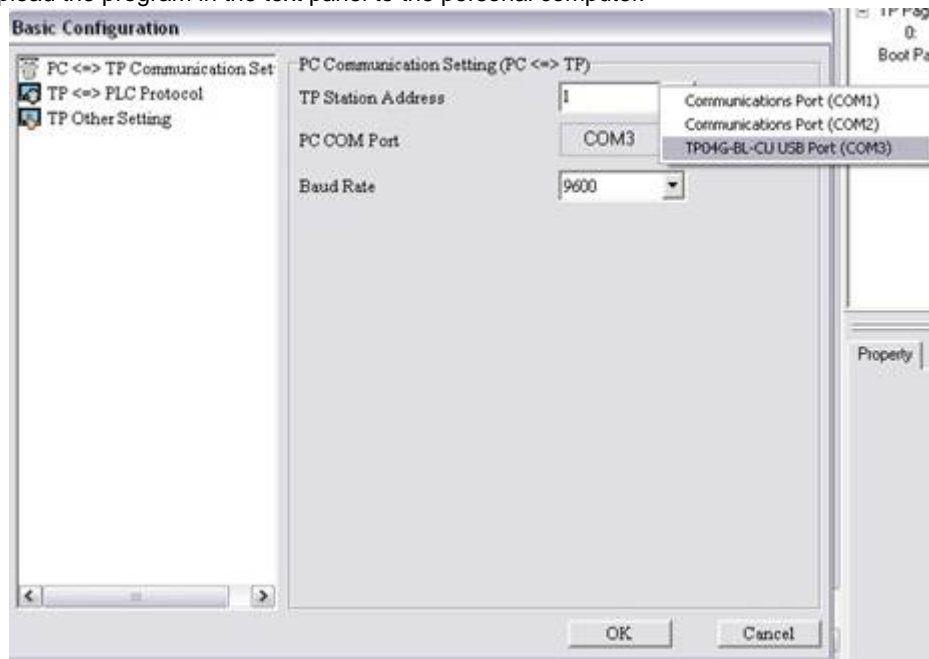

TP <=> PLC Protocol

After users click **TP <=> PLC Protocol** in the **Basic Configuration** window, they can set a communication protocol between a text panel and an external device. The text panel can be connected to the external device only if the communication protocol of the text panel and the communication of the external device are the same. In the example in this chapter, the communication protocol between the VFD-M series AC motor drive used and TP70P is "9600, 7, E, 1".

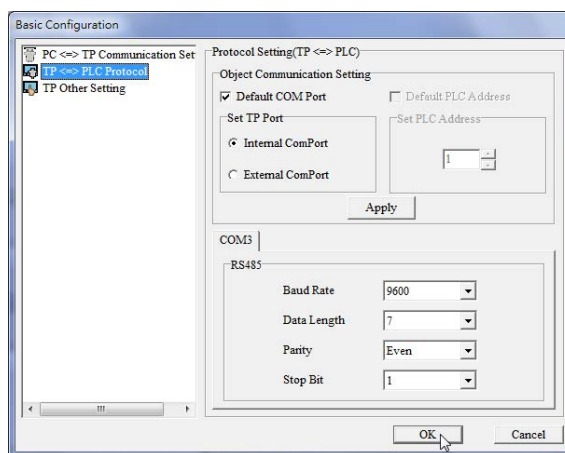

TP Other Setting

After users click **TP Other Setting** in the **Basic Configuration** window, they can select a station address, set the brightness of the backlight that illuminates the screen of TP70P, enable the buzzer of TP70P, set a password, select a boot page, etc. In the example in this chapter, a user-defined boot page is designed, and therefore the **User Define** option button in the **Start-Up Menu Display** section is selected.

2

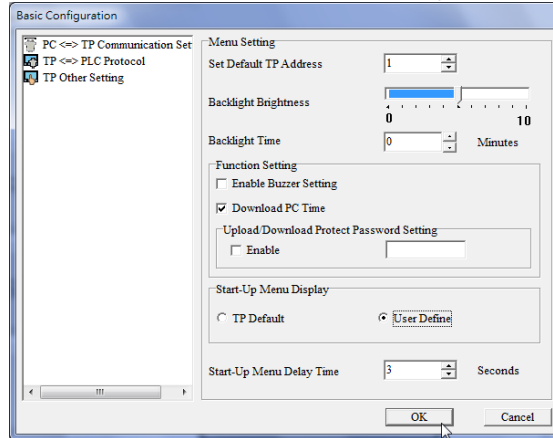

2.4.5 Compile and Downloading a Program

After users write a program, and adjust related settings, they can download the program to a text panel. The users have to compile the program first. After the users click **Build All** on the **Compile** menu, or  on the standard toolbar, the program will be compiled. If the program is compiled successfully, the percentage of memory used will be shown.

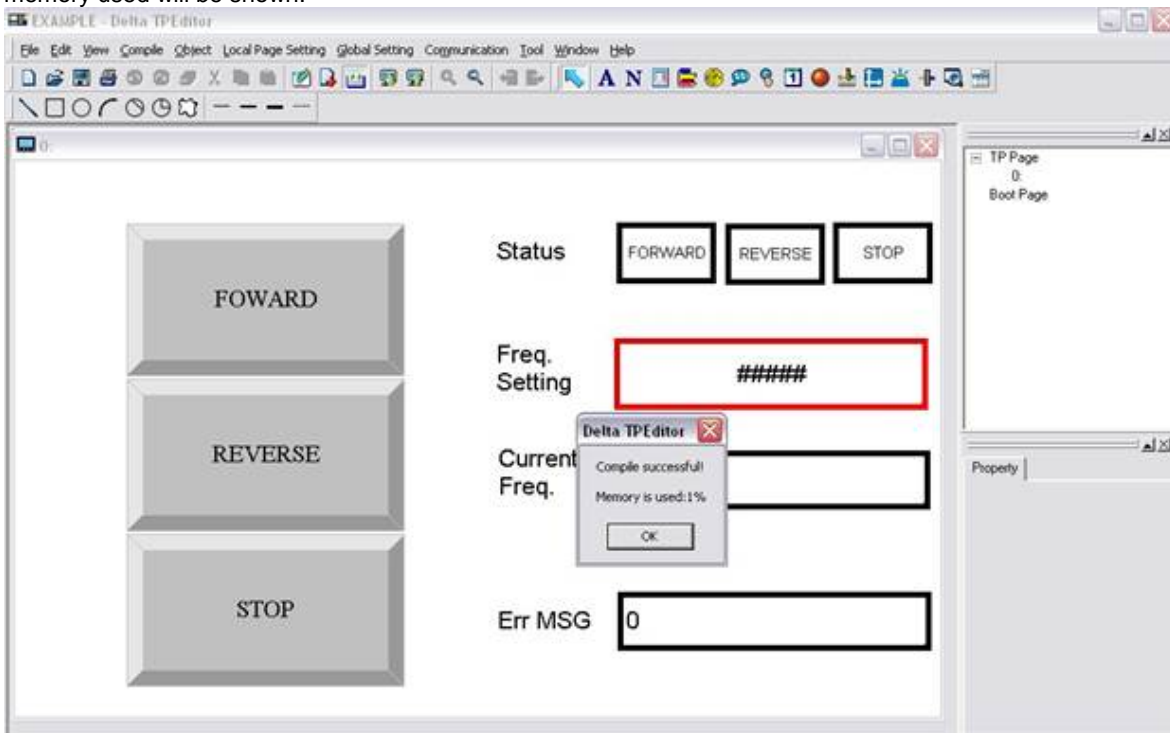

After the program is compiled, the users can download the program. After the users click **Write to TP** on the **Communication** menu, or  on the standard toolbar, the **Download Setting** window will appear.

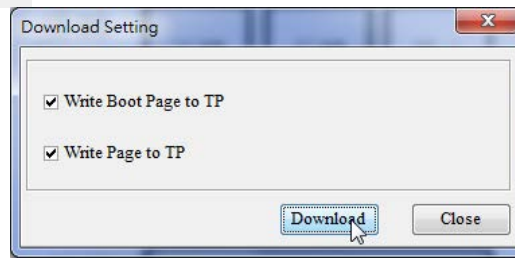

After the users make sure of the pages which need to be downloaded, and click **Download** in the **Download Setting** window, the **Confirm** window will appear.

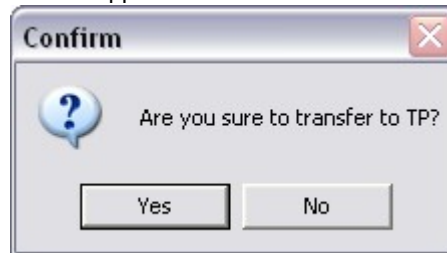

After the transmission of the program is complete, a message saying the the downloading of the program is complete will appear.

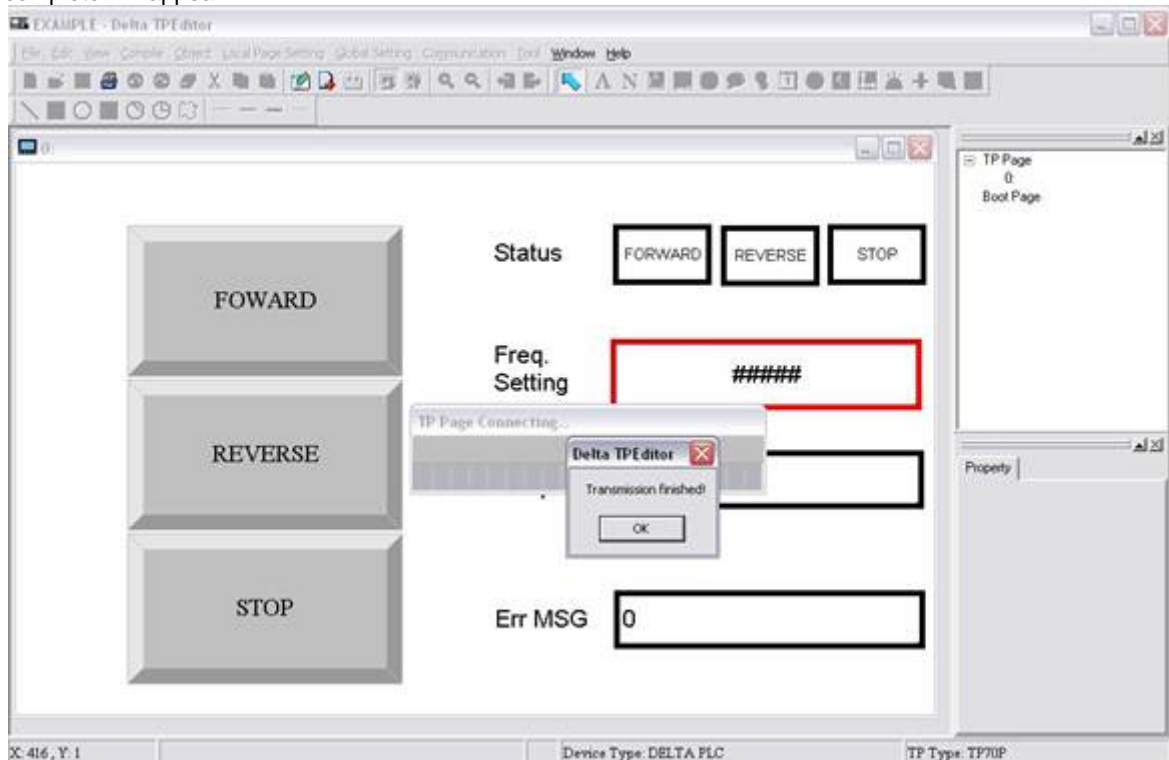

2

2.5 Writing a Program for a PLC

TP70P can be used to integrate control, and execute and display functions. The conditions which control actions can be created in a PLC program. The writing of a program for the PLC used in the example in this chapter is described below. The Delta software which supports TP70P is WPLSoft and ISPSOft. Please refer to WPLSoft User Manual and ISPSOft User Manual for more information about the usage of WPLSoft and ISPSOft. In the example in this chapter, WPLSoft version 2.36 is used to write a program for the PLC used.

Step 1: Start WPLSoft. (**Start**→**Programs**→**Delta Industrial Automation**→**PLC**→**WPLSoft 2.36**→**WPLSoft 2.36**)

2

Welcom screen



Main screen

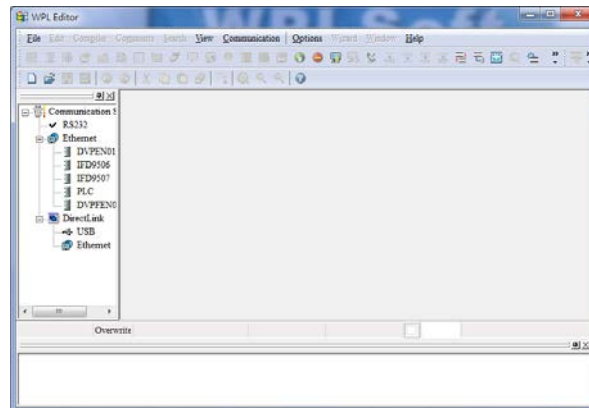

Step 2: After  is clicked, a new project will be added. In the **Select a PLC Model** window, type “TP70-VFD CTRL” in the **Program Title** box, select **TP70P/TP70G** in the **Select** drop-down list box, and type “TP70 example” in the **File Name** box.

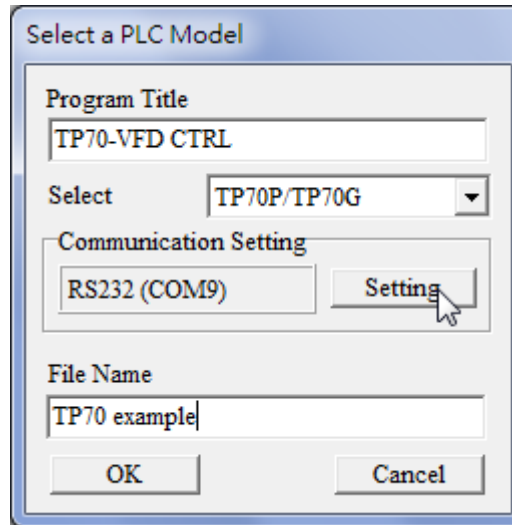

Step 3: After **Setting** in the **Communication Setting** section is clicked, the **Communication Setting** window will appear. Select **RS232** in the **Type** drop-down list box, and select the communication port which is connected to TP70P. The communication protocol set in the **Communication Setting** window need to be the communication protocol of TP70P. The default communication protocol set in the **Communication Setting** window is “9600, 7, E, 1”. Select **1** in the **Station Address** box. Click **OK** after the adjustment of settings in the **Communication Setting** window is complete.

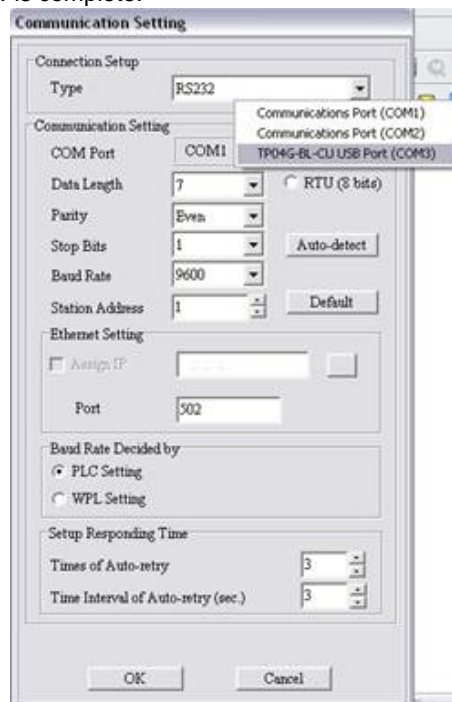

After **OK** in the **Communication Setting** window is clicked, a project environment will be displayed (the program title set will appear in the upper left corner of the **Delta WPLSoft** window).

2

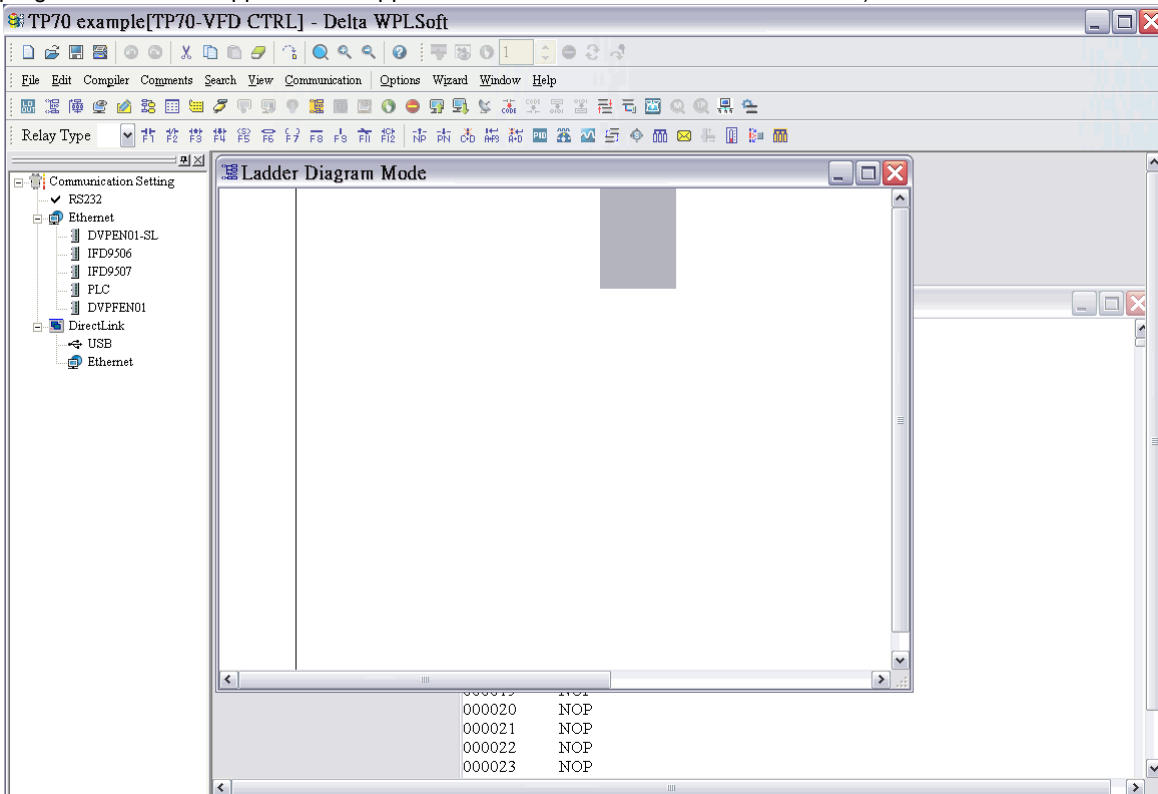

2.5.1 Planning a Program

In order to meet the requirements of the system used in the example in this chapter, the following conditions need to be planned.

Planning devices

- M0→Forward rotation control
- M1→Backward rotation control
- M2→Stop control
- M3→Stop flag
- Y0→Forward rotation output
- Y1→Backward rotation output

Planning actions

- If M0 is ON, Y0 will be ON.
- If M1 is ON, Y1 will be ON.
- If M2 is ON, Y0 and Y1 will be OFF.
- If Y0 is ON, M1 will be ineffective.
- If Y1 is ON, M0 will be ineffective.
- If Y0 and Y1 are OFF, the AC motor drive used will stop running, and M3 will be ON.

2.5.2 Control Program

The control program shown below is created according to the conditions planned in section 2.5.1. Please refer to WPLSoft User Manual for more information about the usage of WPLSoft.





2

2.5.3 Compiling and Downloading a Program

After users write the program shown in section 2.5.2, they can download the program to TP70P. The users have to compile the program first. After the users click **Ladder => Instruction** on the **Compiler** menu, or  on the standard editing toolbar, the program will be compiled. The result of the compiling of the program is shown in the message area in WPLSoft.

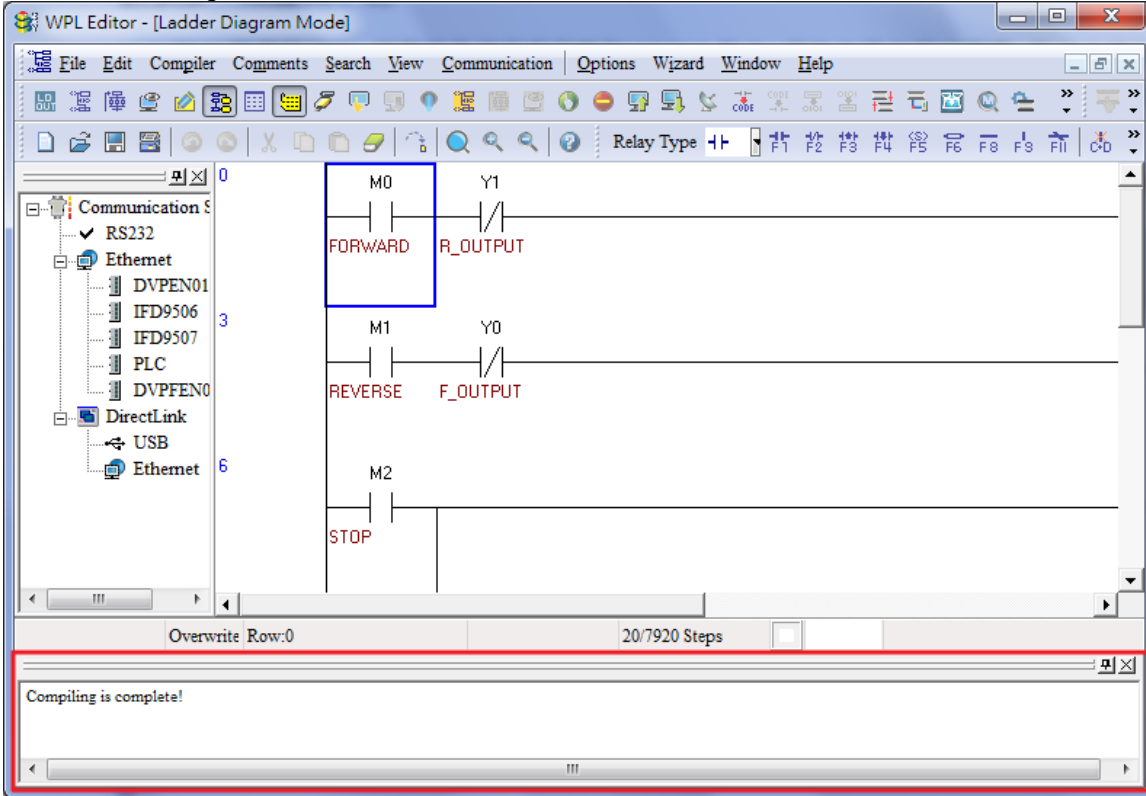
2



After the program is compiled, the users can download the program. After the users click , the **Transfer Setup** window will appear. The users can select checkboxes in the **Transfer Setup** window. Owing to the fact that there are comments on the devices in the program, the **Device Comment** checkbox in the **Transfer Setup** window is selected.

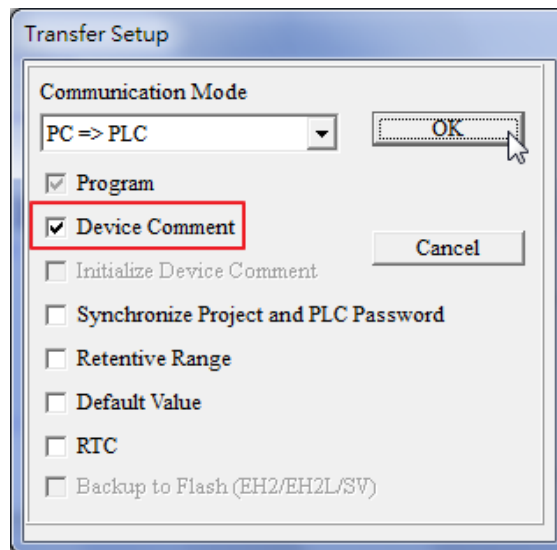

After the users select the **Device Comment** checkbox, the **System Block** window will appear. The users can select devices and set device ranges.

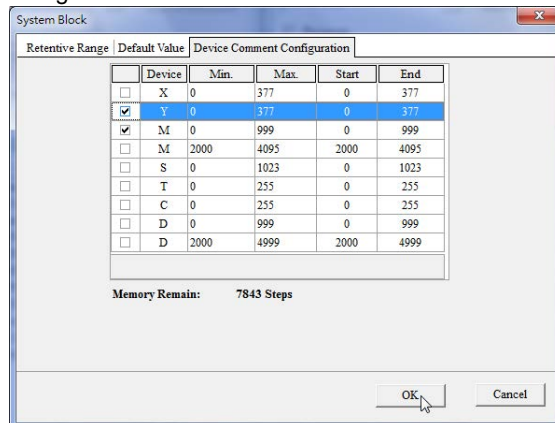

2

After the users click **OK** in the **Transfer Setup** window, the program will be downloaded to TP70P.

2.6 Monitoring and Debugging a Program

2.6.1 Monitoring a Program

When a program is executed by a system, users can understand the current logic state of the system by monitoring the program, or test the system by changing the values in devices.

- **Monitoring a program**

Users have to open the program which has been compiled in section 2.5.3.

After the users click , the program will be monitored. The program is composed of a logic program, and the information related to devices. (The states of Boolean devices are indicated by green backgrounds or white backgrounds, and the information about other devices is indicated by values or text.)



If the users want to change the state of a device, they can right-click the device, and click an item on the context menu which appears. In the figure below, M0 is set to ON.

2

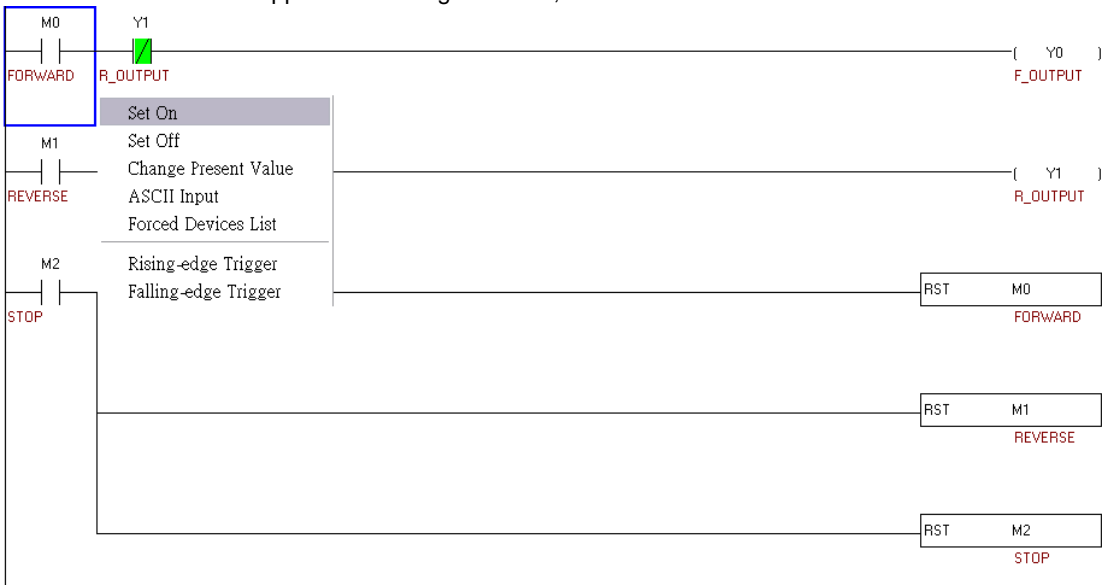

Note: **Set On** and **Set Off** can not be used to change the state of a device corresponding to an actual I/O device because the state of the actual I/O device immediately overwrites the value which is set. **Force ON** and **Force OFF** can be used instead.

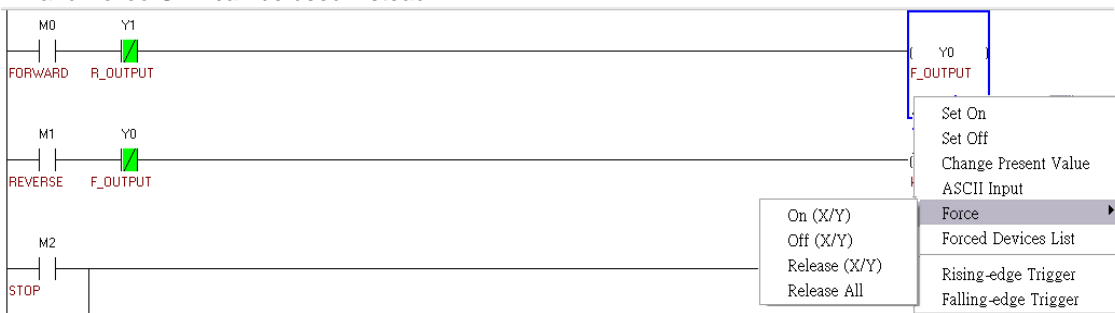

- **Monitoring devices**

It is sometimes inconvenient for users to search for devices in a logic program that the users test, and change the values in the devices because the devices are in different sections of the logic program. Besides, sometimes the purpose of modifying the values in devices in a program is not to debug the program, but to test an external device. If the users want to change the values in devices in a program by monitoring the program, they may not easily find the devices, and they need to have the program. To solve these problems, the users can use a device monitoring table. If the users change the values in devices in a program by means of a device monitoring table, they do not even need the program.

The users have to click , and then double-click the device monitoring table which appears.

After the users type a device name and the number of devices, and click **Input** in the **Device monitor input** window, devices will be brought into the device monitoring table.

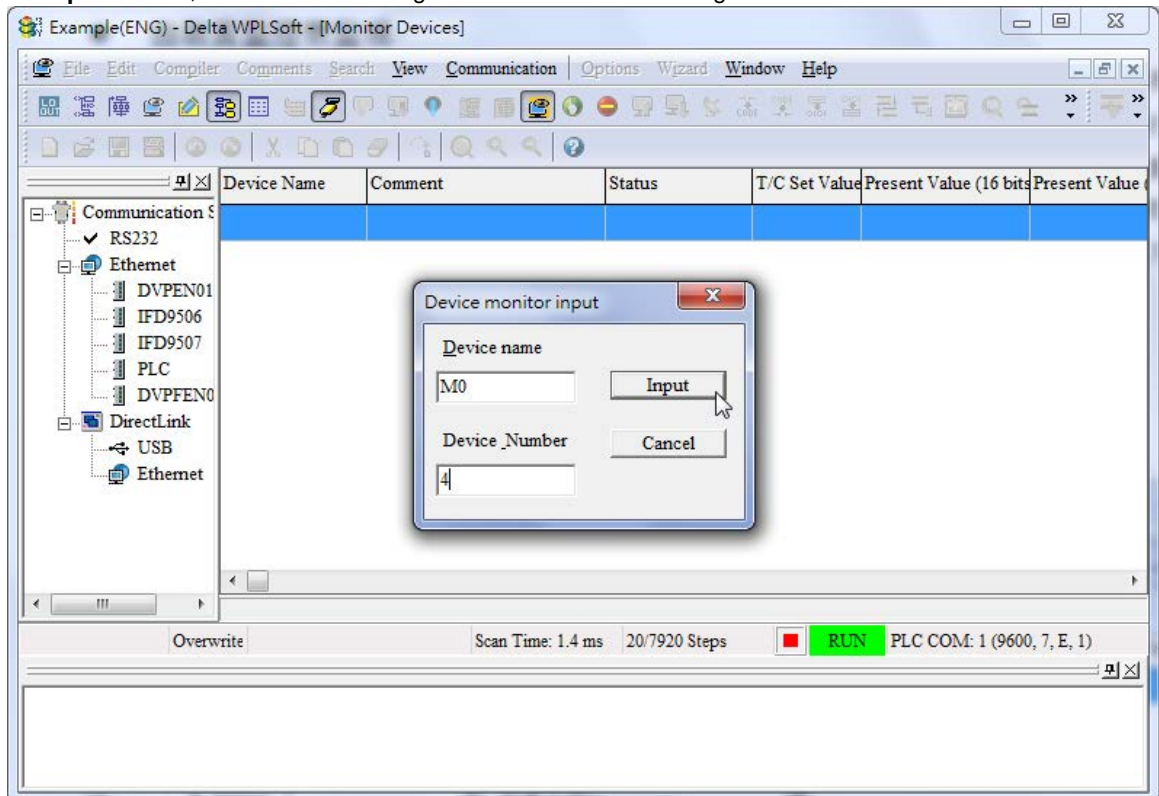

2

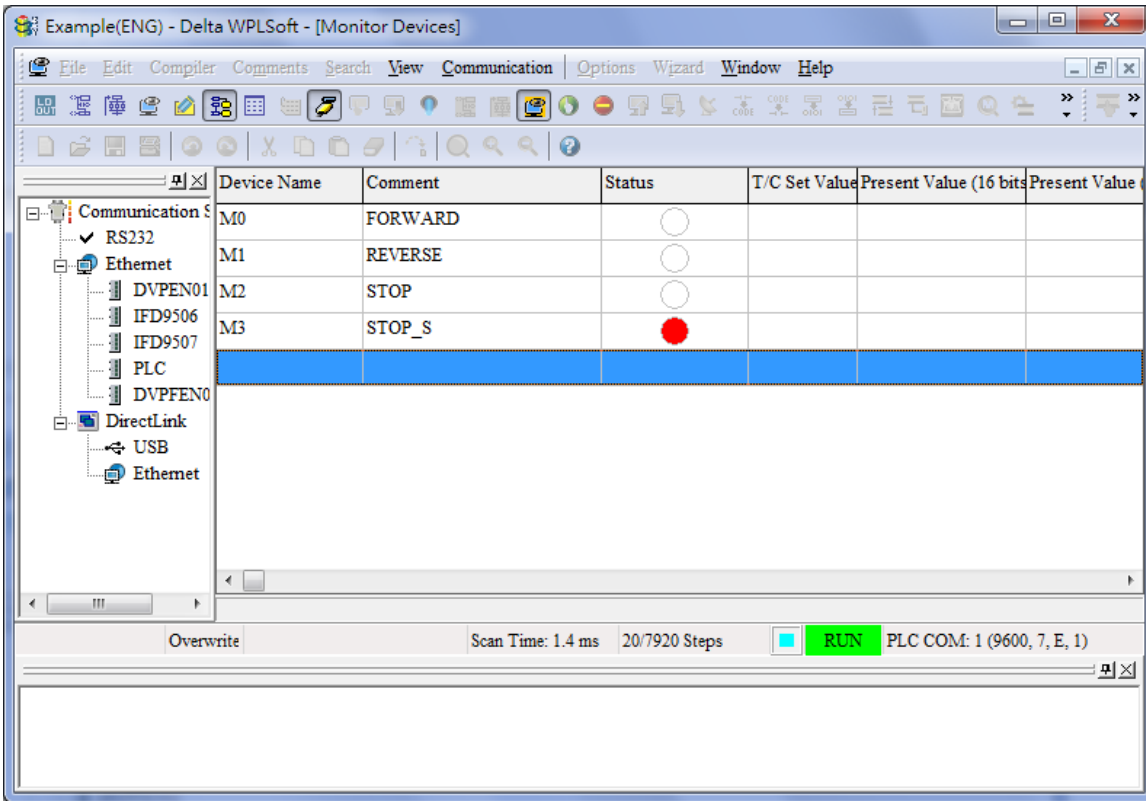

The states of the devices brought into the device monitoring table will be shown only if  is pressed. If the users want to change the state of a device, they can right-click the device, and click an item on the context menu which appears. M0 is set to ON here. When M0 is ON, Y0 is ON, the AC motor drive used rotates forwards, and the users can see that the forward rotation indicator on the screen of TP70P is green.

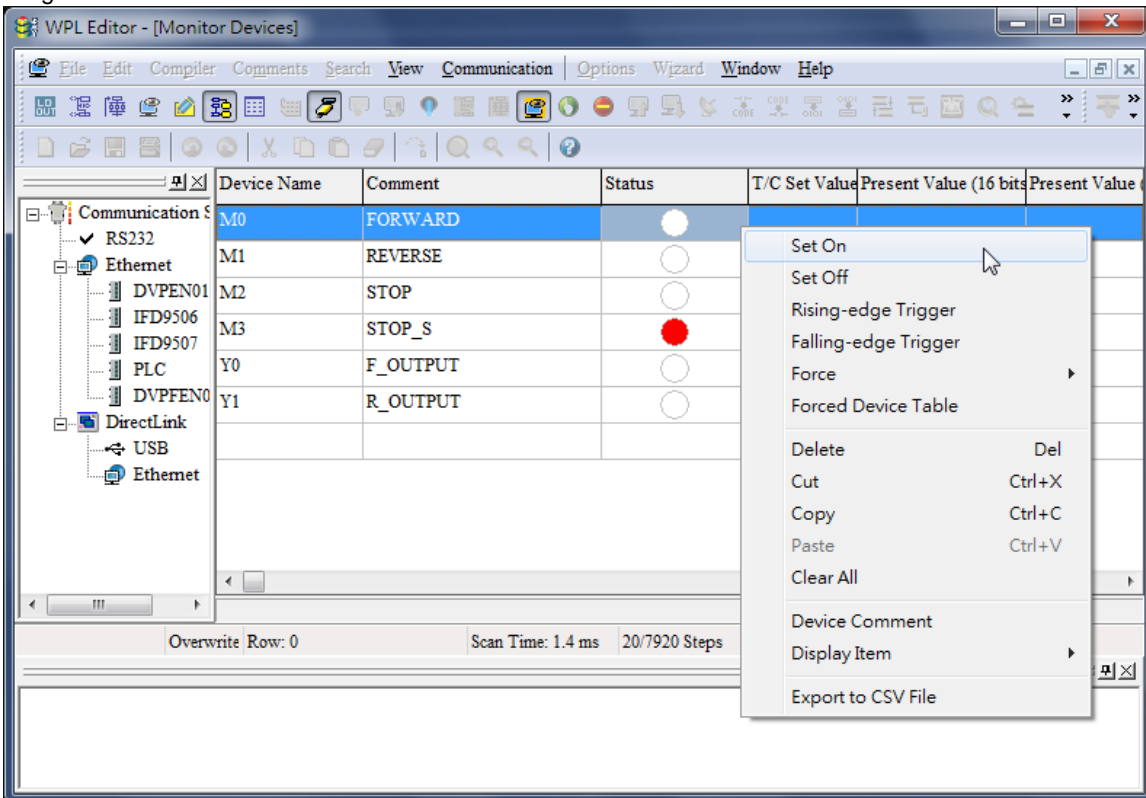

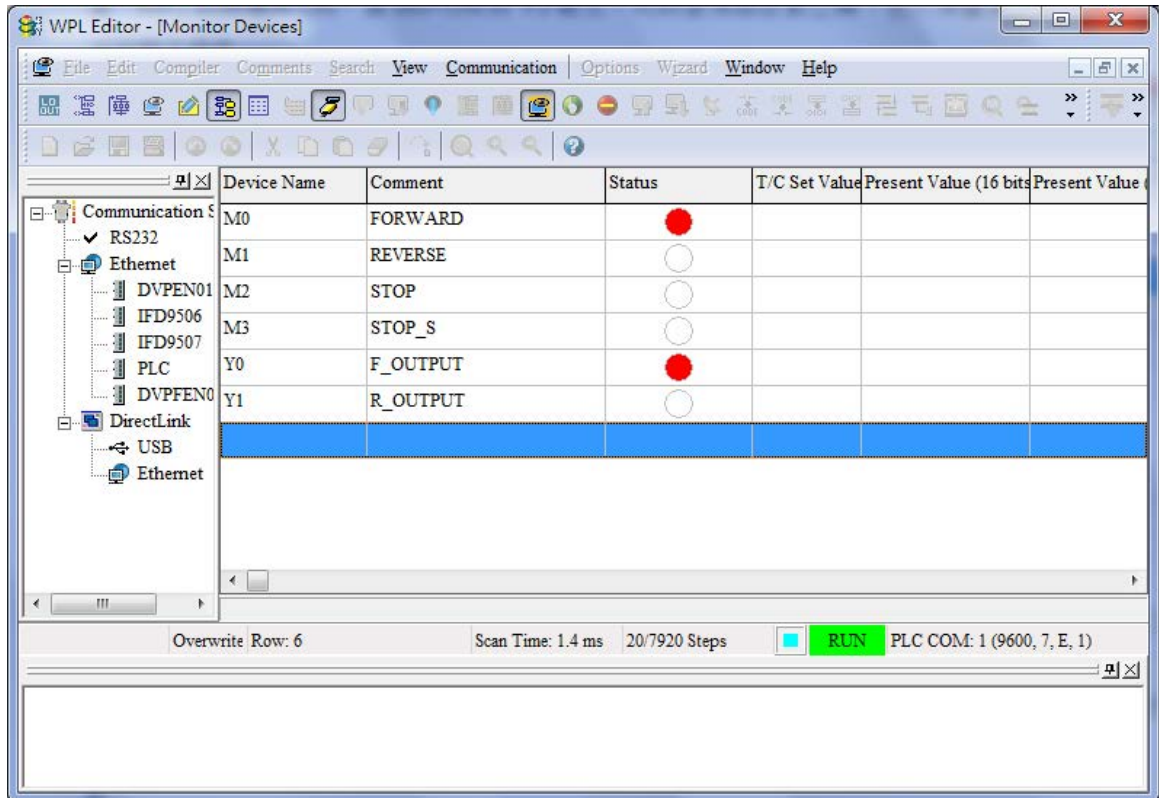



2

2.6.2 Removing System Errors

When a system runs, errors may occur. If users follow the procedure introduced in this chapter, there will be no error. After a program is written to a PLC, M1004 will be ON if an error occurs. The reason for the error may be that operands (devices) are invalid, or syntax is incorrect. It is indicated by the error code (hexadecimal value) in D1004. D1004 can be monitored by means of WPLSoft.

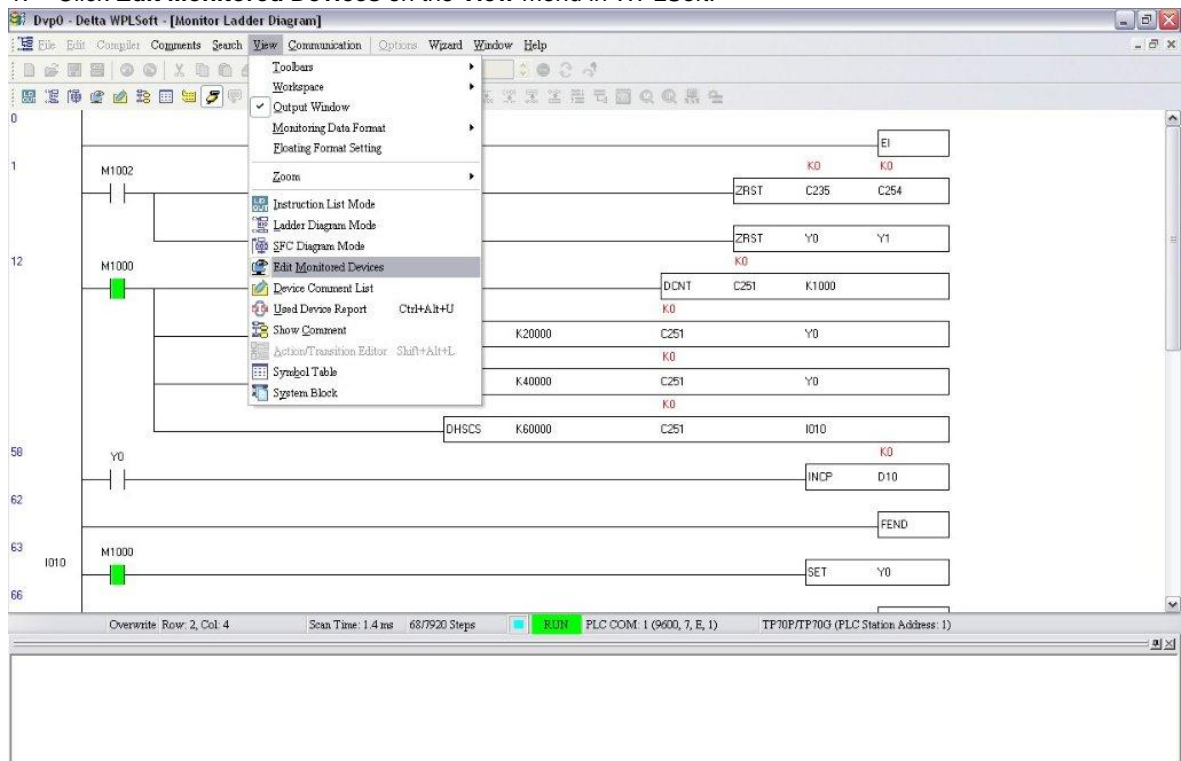
1. Click **Edit Monitored Devices** on the **View** menu in WPLSoft.



2. After  is clicked, the value in D1004 will be shown.

2

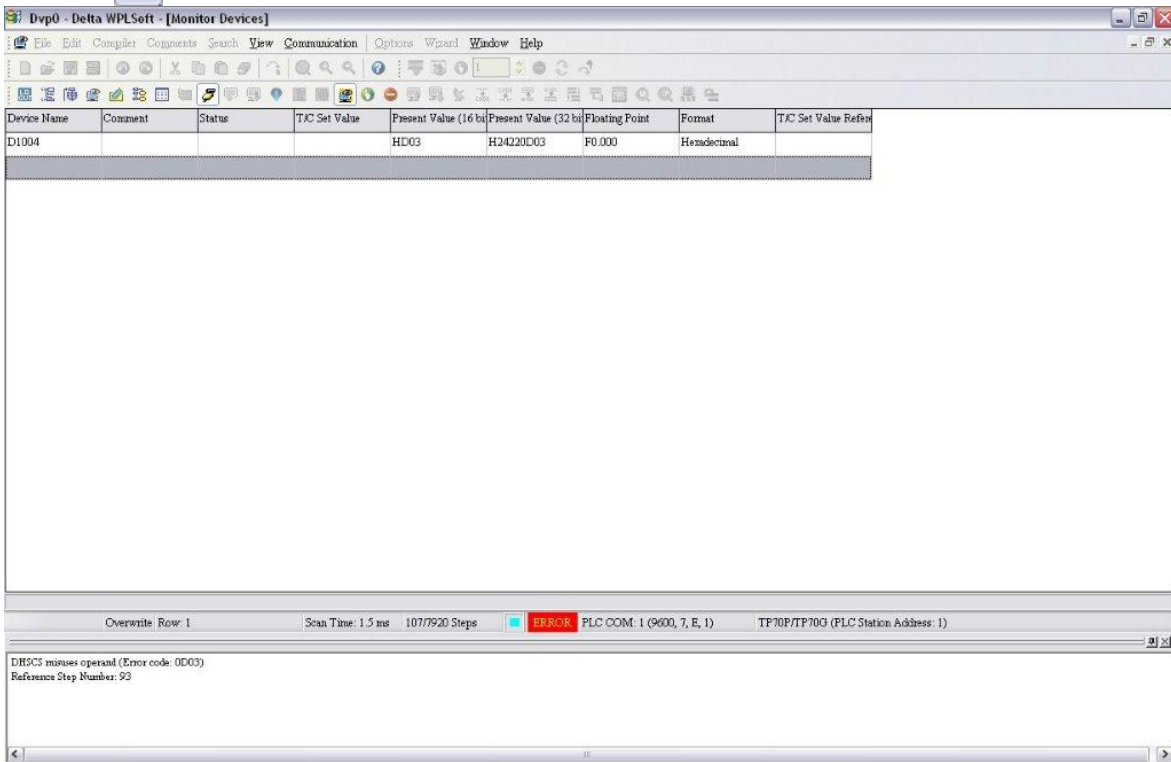

The screenshot shows the Delta WPLSoft interface with the 'Monitor Devices' window open. The status bar at the bottom indicates an error: 'ERROR PLC COM. 1 (9600, 7, E, 1)'. The error message in the main window reads: 'DHSCS misses operand (Error code: 0D03) Reference Step Number: 92'. The data table below shows the current state of device D1004.

Device Name	Comment	Status	TIC Set Value	Present Value (16 bit)	Present Value (32 bit)	Floating Point	Format	TIC Set Value Refer
D1004				HD03	H24220D03	P0.000	Hexadecimal	

3. The error code shown in the figure above is HD03. It indicates that the operands of the instruction DHSCS are invalid. After DHSCS is checked, and the operands are modified, the error will be eliminated.

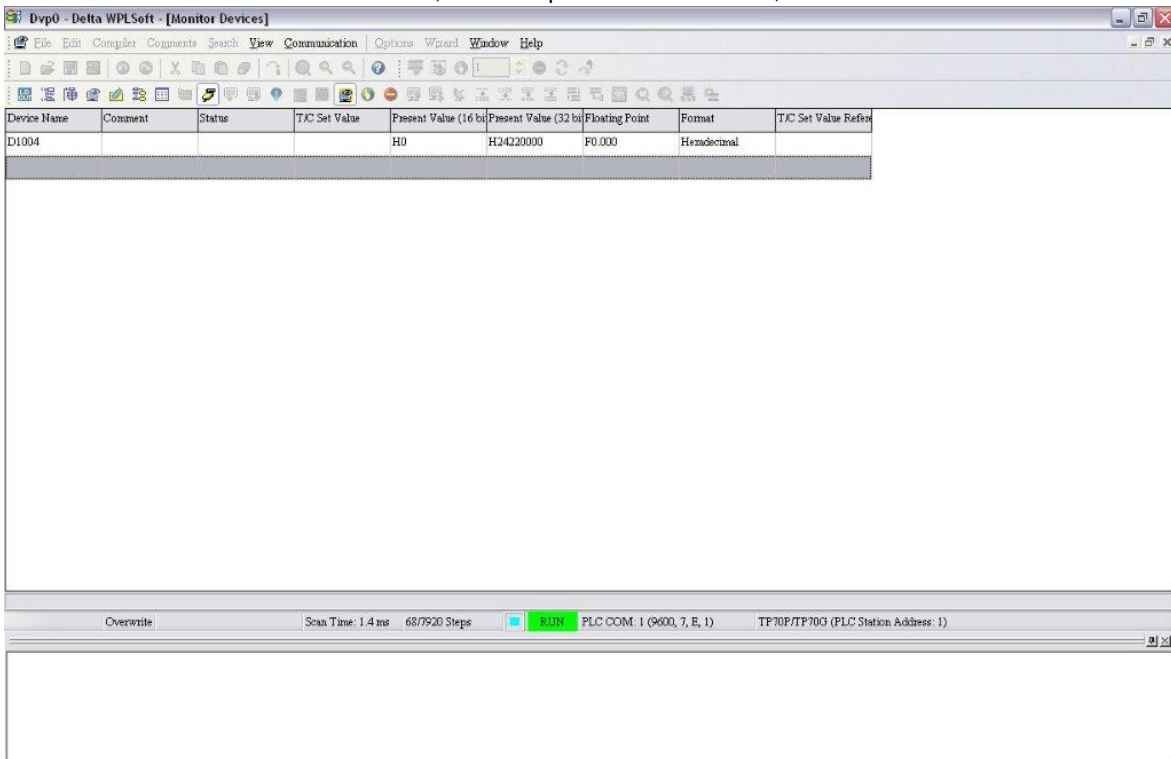

The screenshot shows the Delta WPLSoft interface after the error has been resolved. The status bar now indicates 'RUN PLC COM. 1 (9600, 7, E, 1)'. The error message is no longer present. The data table below shows the updated state of device D1004.

Device Name	Comment	Status	TIC Set Value	Present Value (16 bit)	Present Value (32 bit)	Floating Point	Format	TIC Set Value Refer
D1004				H0	H24220000	P0.000	Hexadecimal	



Chapter 3 Frequently Asked Questions and Answers

Table of Contents

3.1	Installing a USB Driver	3-2
3.2	Descriptions of the Communication Ports on TP70P	3-4
3.3	Setting COM2	3-5
3.4	Using COM2 as a Master Station.....	3-6
3.5	Setting COM3	3-7
3.6	Setting an RTU Mode for COM3	3-9
3.7	Using COM3 as a Slave Station	3-10
3.8	Data Exchange	3-12

3.1 Installing a USB Driver

【Question】 How to install a USB driver?

【Answer】 If users use TP70P for the first time, they have to follow the steps below, and install a USB driver.

1. Download the latest version of TPEditor from the official website of Delta, and install the software. (Official website of Delta: <http://www.delta.com.tw>)
2. After a USB cable is connected to a USB port on the computer, the **Found New Hardware Wizard** window will appear. Please select the **Install from a list or specific location (Advanced)** option button, and click **Next**.

3

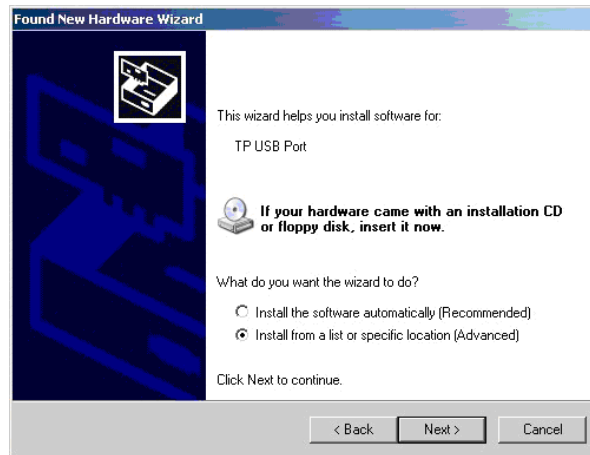

3. Select the **Include this location in the search** checkbox, select the **USB** folder contained inside the directory where TPEditor is installed, and click **Next**. (Default path: C:\Program Files\Delta Industrial Automation\TPEditor X.X\USB)

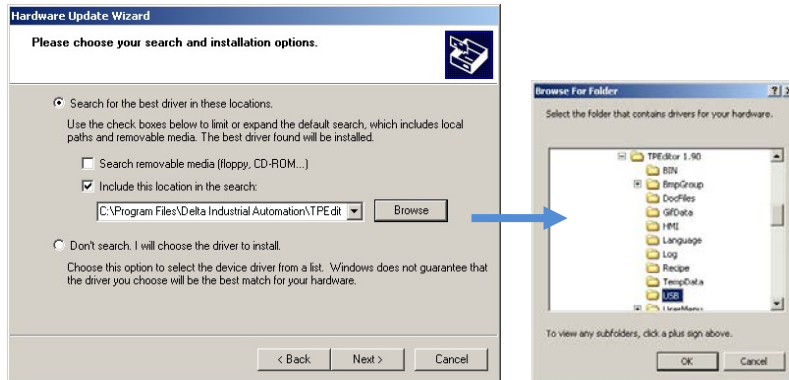

4. After the installation of the USB driver selected is complete, the communication port connected to TP70P will be displayed in the **Ports (COM & LPT)** section in the **Device Manager** window.

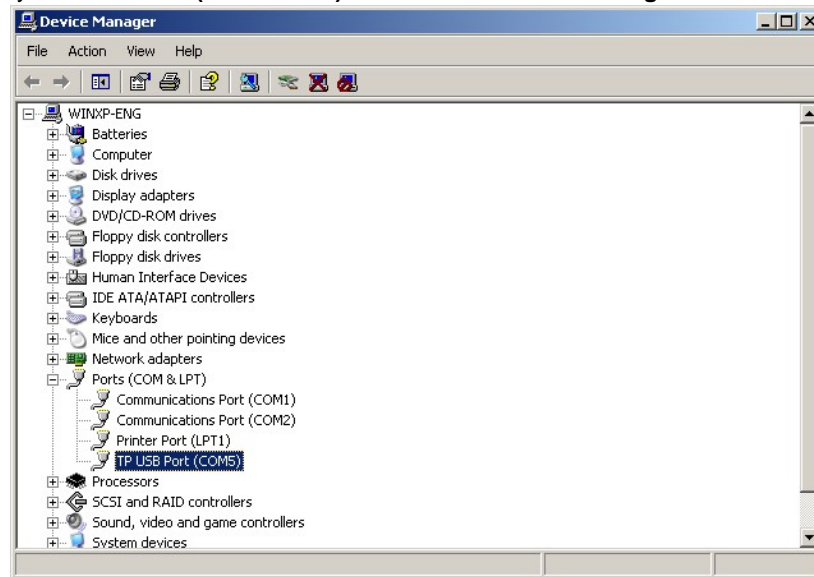

5. The communication port which is connected to TP70P is also shown in the **PC COM Port** box in the **PC Communication Setting (PC <=> TP)** section in TPEditor.

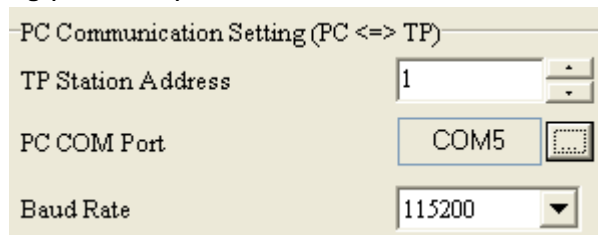

6. TP70P can communicate with the computer by means of the communication port. TPEditor is used to upload/download a text panel program, and WPLSoft is used to upload/download/monitor a PLC program.

3.2 Descriptions of the Communication Ports on TP70P

【Question】 What are the differences among the communication ports on TP70P, and methods of setting the communication ports, and how to set them?

【Answer】 There are three communication ports on TP70P. The modes that the communication ports supports are different, and the methods of setting the communication ports are also different. Please refer to the table below for more information. COM1, COM2 and COM3 can be used simultaneously. The station address of COM1 and the station address of COM2 are the same. The station address of COM3 is different from the station address of COM1 and the station address of COM2.

3

Communication port	Interface	Mode supported	Method of setting a communication port
COM1	USB	COM1 supports connection to software, and the uploading/download of a program.	Users have to install a USB driver if COM1 is used for the first time.
COM2	*1	PLC mode	COM2 is set by means of special D devices and special M devices in the PLC.
COM3	*1	Text panel mode	COM3 is set by means of objects in the text panel.

*1. Please refer to section 1.9 for more information.

COM1

COM1 can not function as a master station. It only supports the uploading/downloading of a program. If users use COM1 for the first time, they need to install a USB driver so that the computer can identify the virtual communication port which is connected to COM1. Please refer to section 3.1 for more information about installing a USB driver.

COM2

COM2 can be used as a master station or a slave station. It supports ASCII/RTU communication. Users can set a serial transmission rate. The maximum transmission rate which can be set is 115 kbps. The users can set the number of data bits, a parity bit, and the number of stop bits. If RTU communication is used, the number of data bits must be eight. D1120 in the PLC is used to set a communication protocol. If a communication error occurs in COM2, the users can check special M devices.

COM3

COM3 supports the text panel. After a driver is selected, COM3 can function as a master/slave station, and support ASCII/RTU communication. Users can set a serial transmission rate. The maximum transmission rate which can be set is 115 kbps. The users can set the number of data bits, a parity bit, and the number of stop bits. If a communication error occurs in COM3, a warning window showing that a communication error occurs will appear on the screen of the text panel.

3.3 Setting COM2

【Question】 How to set COM2?

【Answer】 COM2 supports the PLC. It is set in the same way as a DVP series PLC is. It is set by means of special D registers and special M devices. Please refer to the table below for more information.

Communication parameter	Register
Communication format	D1120
The communication set holds.	M1120
ASCII (Off)/RTU (On) mode	M1143
Slave station address	D1121
Communication timeout	D1129
A communication timeout occurs.	M1129

Users can set a communication protocol according to the table below.

		Contents	
b0	Data length	0: 7 1: 8 (If RTU communication is used, the number of data bits set must be 8.)	
b1 b2	Parity bit	00: None 01: Odd 11: Even	
b3	Number of stop bits	0: 1 bit 1: 2 bits	
b4 b5 b6 b7	Serial transmission rate	0001 (H1): 110 0010 (H2): 150 0011 (H3): 300 1011 (H4): 600 0101 (H5): 1200 0110 (H6): 2400 0111 (H7): 4800 1000 (H8): 9600 1001 (H9): 19200 1010 (HA): 38400 1011 (HB): 57600 1100 (HC): 115200 1101 (HD): 500000 1110 (HE): 32150	
b8	Start-of-text character	None	D1124
b9	First end-of-text character	None	D1125
b10	Second end-of-text character	None	D1126
b11~b15	undefined		

Example: COM2 uses ASCII communication.

If the communication format that COM2 uses is the ASCII communication protocol (9600, 7, E, 1), the program code below must be added to the top of the program in the PLC. When the PLC runs during the first program scan, it checks whether M1120 is ON. If M1120 is ON, the setting of COM2 will be changed according to the value in D1120.

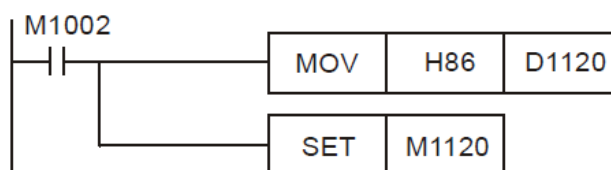

Example: COM2 uses RTU communication.

If the communication format that COM2 uses is the RTU communication protocol (9600, 8, E, 1), the program below will be required.

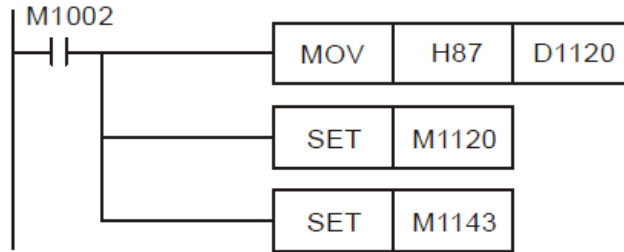

3

Notes:

1. After the modification of the communication format that COM2 uses is complete, the communication format that COM2 uses will not change if the PLC stops running.
2. After the modification of the communication format that COM2 uses is complete, the communication protocol that COM2 uses will be the default communication protocol (9600, 7, E, 1) if the PLC is turned off and then powered when it stops running.
3. If COM2 functions as a slave station, users only need to set a communication format. If COM2 functions as a master station, a Modbus command will need to be sent by means of a communication instruction (MODRD/MODWR/MODRW)

3.4 Using COM2 as a Master Station

【Question】 How to use COM2 as a master station?

【Answer】 If COM2 is used to as a master station connected to another device, commands will need to be sent by means of the Modbus instructions in the program in the PLC. Please refer to Chapter 4 in DVP-ES2/EX2/SS2/SA2/SX2/SE&TP Operation Manual for more information about the communication ports on a PLC. (Users can download DVP-ES2/EX2/SS2/SA2/SX2/SE&TP Operation Manual from the official website of Delta (<http://www.delta.com.tw>).)

Using COM2 to read the data in a DVP series PLC and write data to a DVP series PLC is described below.

Example: COM2 is used to set Y0 on a DVP series PLC to ON.

Step 1: Please download the program below to TP70P.



Step 2: Connect COM2 to the two RS-485 wires connected to a DVP series PLC. When TP70P runs, Y0 on the DVP series PLC is ON.



Step 3: If communication error judgement is required, the program below can be added. If communication data is transmitted normally, M0 will be ON. If a communication timeout occurs, M1 will be ON. If the data received is incorrect, M2 will be ON. If parameters of an instruction are set incorrectly, M3 will be ON. Users can judge the state of communication by means of these flags.

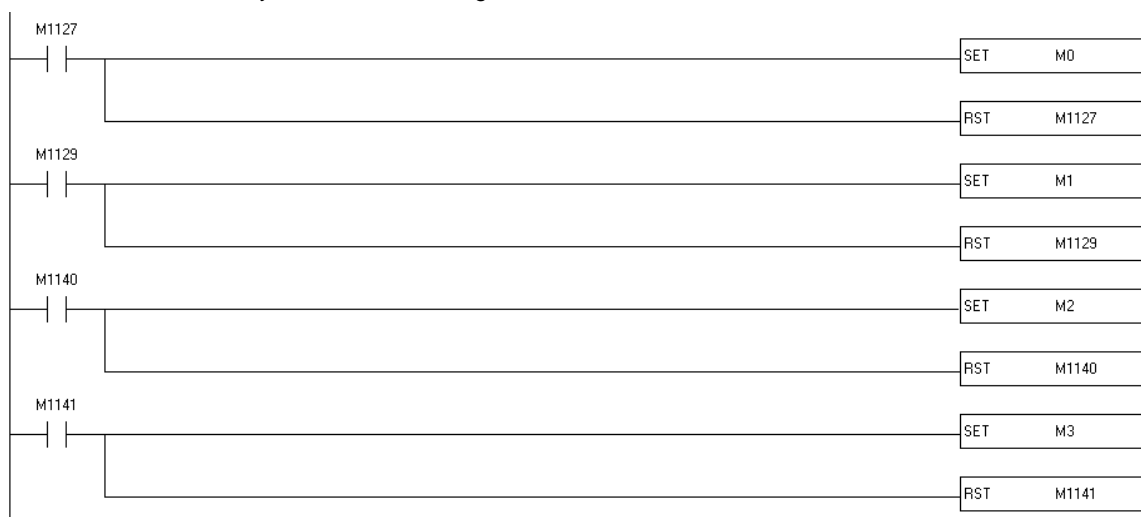

3.5 Setting COM3

【Question】 How to set COM3?

【Answer】 COM3 supports the text panel. After a driver is selected, COM3 can function as a master/slave station. Users can set a communication format for COM3 in the **Basic Configuration** window in TPEditor. The drivers supported by TP70P are shown in the table below. The setting of COM3 is described below.

Master/Slave	Driver
Master	Delta PLC
	Delta Inverter VFD
	Delta ASD AC Servo
	Delta VFD ASCII Mode
	Delta VFD RTU Mode
	Delta Modbus ASCII
	Delta Modbus RTU
	Modicon Modbus RTU Mode
Slave	Modbus Slave ASCII Mode
	Modbus Slave RTU Mode

3

Example: COM3 is used to read the value in D0 in a DVP series PLC.

Step 1: Select **DELTA PLC** in the **HMI <=> PLC** section in the **New Project** window.



3

Step 2: Create a numeric display in the working area. Select the **External PLC Setting** option button, and set a PLC address in the **Refer Device** window. (In the example, the PLC address set is 1.)

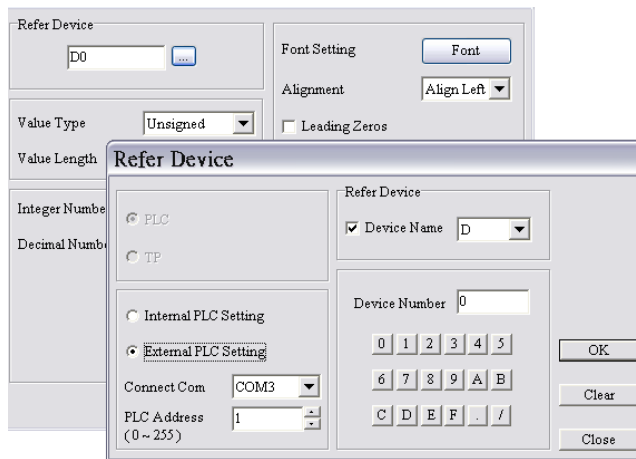

Step 3: In the **Basic Configuration** window, click **TP <=> PLC Protocol**, and then set a communication format for COM3. (In the example, the communication format set is (9600, 7, E, 1).)

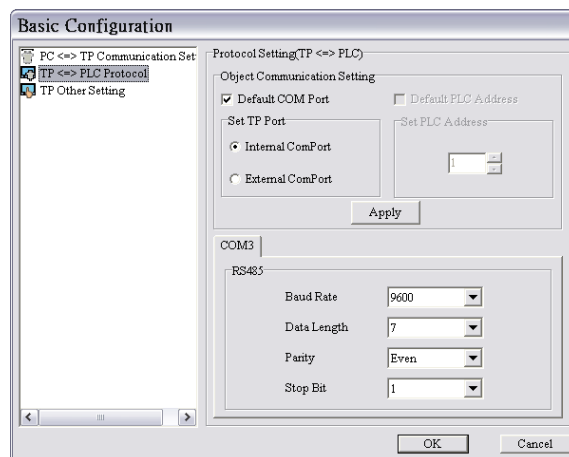

Step 4: Compile the program created, and download the program to TP70P. Connect COM3 on TP70P to an RS-485 communication port on a PLC.



3.6 Setting an RTU Mode for COM3

【Question】 How to set an RTU mode for COM3?

【Answer】 When COM3 functions as a master station, it supports three RTU drivers. One is a Delta VFD RTU mode. It supports the RTU modes of Delta AC motor drives. Another is a Delta Modbus RTU mode. It can be used to connect a product which supports Delta Modbus. The other is a Modicon Modbus RTU mode. It can be used to connect a product which supports Modicon Modbus RTU communication. The example below describes how a TP70P series text panel which uses Delta Modbus RTU communication is connected to a PLC.

Example: An RTU mode is used to read the value in D0 in a DVP series PLC.

Step 1: Select **DELTA Modbus RTU** in the **HMI <=> PLC** section in the **New Project** window.

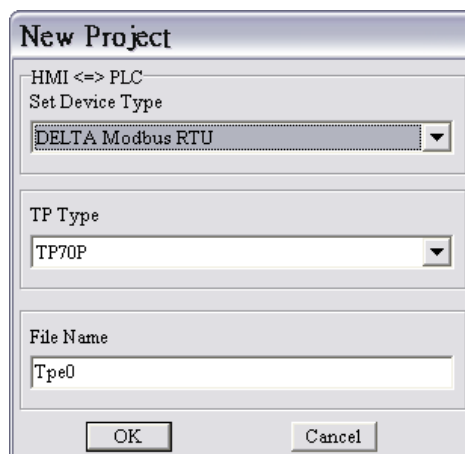

Step 2: Create a numeric display in the working area. Select the **External PLC Setting** option button, and set a PLC address in the **Refer Device** window. (In the example, the PLC address set is 1.) Type a standard Modbus communication address in the **Device Number** box.

3

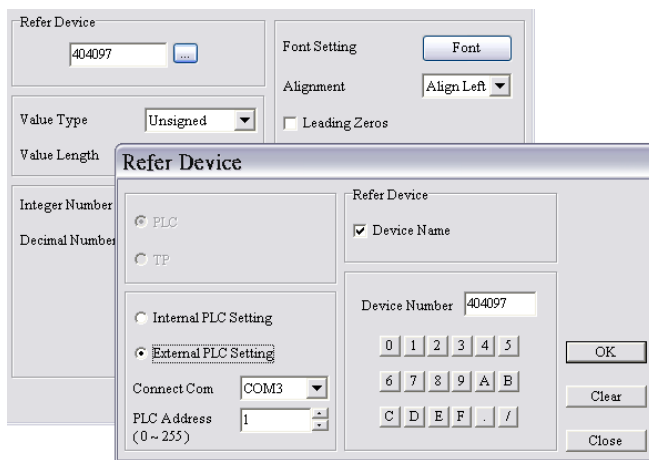

Step 3: In the **Basic Configuration** window, click **TP <=> PLC Protocol**, and then set a communication format for COM3. (In the example, the communication format set is (9600, 7, E, 1).)

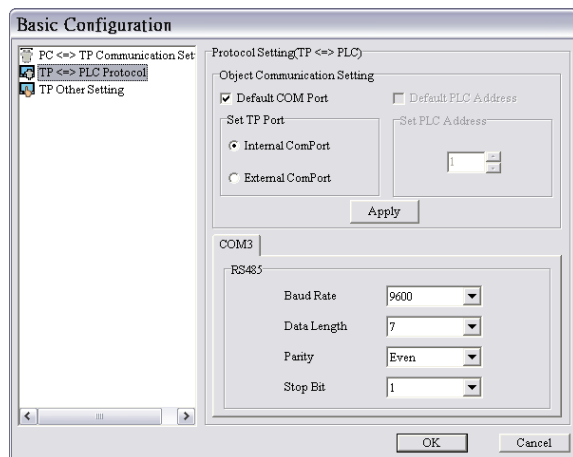

Step 4: Compile the program created, and download the program to TP70P. Connect COM3 on TP70P to an RS-485 communication port on a PLC.



3.7 Using COM3 as a Slave Station

【Question】 How does a device read data in TP70P through COM3 on TP70P?

【Answer】 COM3 supports Modbus slave ASCII/RTU modes. The example below describes how a device read data in TP70P through COM3 on TP70P.

Example: A PLC modifies data in TP70P through an RTU mode.

Step 1: Select **Modbus Slave RTU Mode** in the **HMI <=> PLC** section in the **New Project** window.

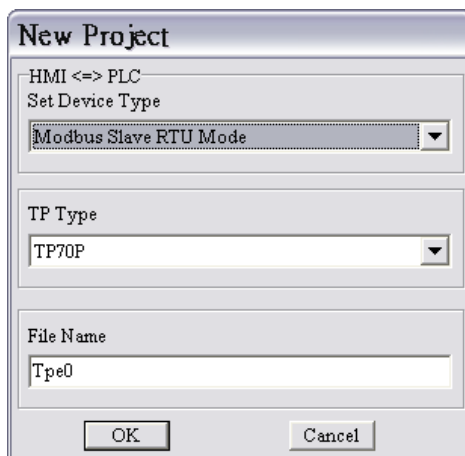

3

Step 2: Create a numeric display in the working area. Type a Modbus communication address in the **Device Number** box.



Step 3: In the **Basic Configuration** window, click **TP <=> PLC Protocol**, and then set a communication format for COM3. (In the example, the communication format set is (9600, 7, E, 1).)

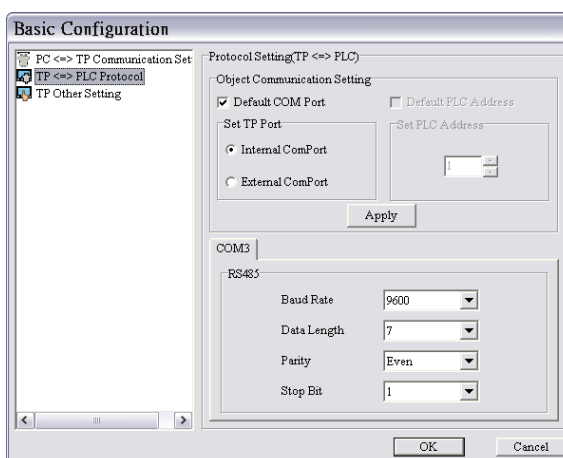

Step 4: Compile the program created, and download the program to TP70P. Connect COM3 on TP70P to an

RS-485 communication port on a PLC.

Step 5: Download the program below to the PLC.



3

Step 6: When the PLC runs, users can see that the value displayed on the screen of TP70P is changed to 1.



3.8 Data Exchange

【Question】 How does TP70P exchange data with a device by means of COM3 instead of objects in TP70P?

【Answer】 TP70P can exchange data with a device by means of COM3. Users have to select the **Read Block Setting** checkbox and the **Write Block Setting** checkbox, and specify devices in the **Read/Write Block Setting** section in the **System Parameter Setting** window. The devices specified are groups of consecutive devices. Thirty-two values at most can be read/written at a time. The example below describes how TP70P communicates with a DVP series PLC by means of COM3. The communication is composed of two parts.

1. **Read Block Setting:** The values in D0~D7 in the DVP series PLC are read, and then put in D0~D7 in TP70P.
 2. **Write Block Setting:** The values in D10~D17 in TP70P are written to D10~D17 in the DVP series PLC.
- **Read Block Setting:** The values in D0~D7 in the DVP series PLC are read, and then put in D0~D7 in TP70P.

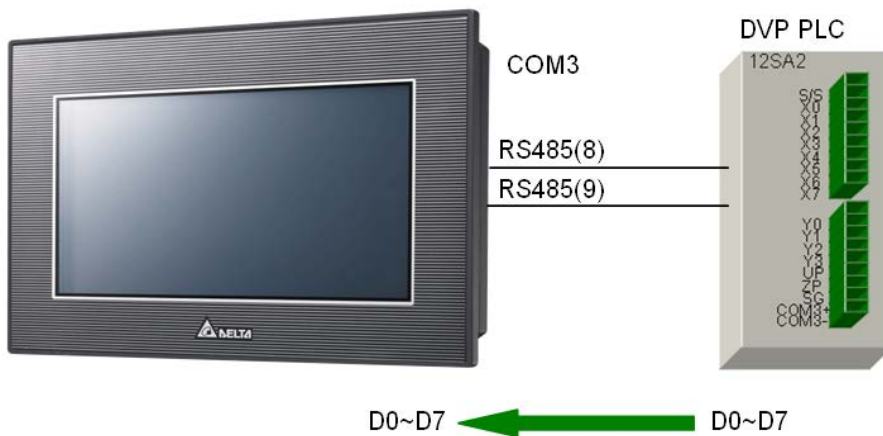

Step 1: Click **System Parameter Setting** on the **Global Setting** menu.

- Step 2:** Select the **Read Block Setting** checkbox in the **Read/Write Block Setting** section.
Read Start Addr.: The values in D0~D7 in the DVP series PLC are read.
Write Start Addr.: The values which are read are put in D0~D7 in TP70P.

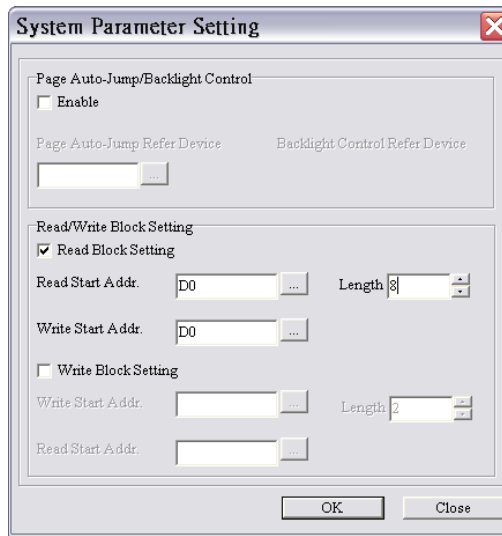

3

- Step 3:** Click **...** at the right side of the **Read Start Addr.** box. Select the **External PLC Setting** option button and D0 in the **Refer Device** window.

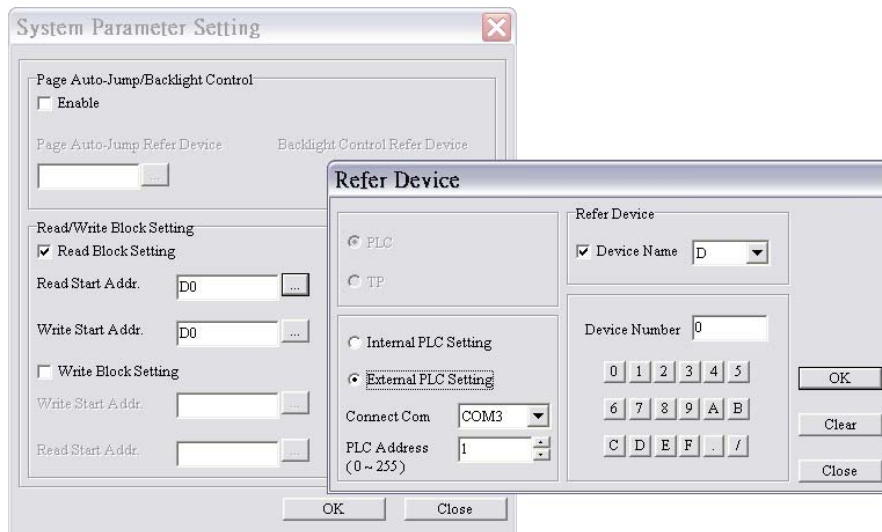

- **Write Block Setting:** The values in D10~D17 in TP70P are written to D10~D17 in the DVP series PLC.

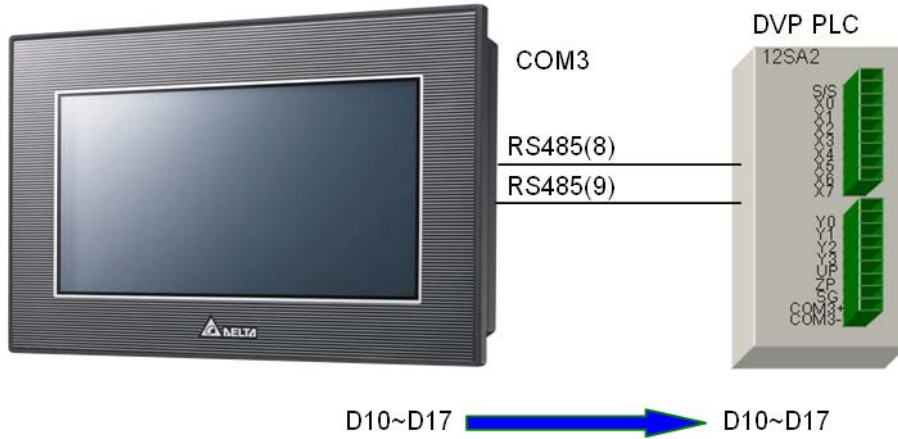

3

- Step 1:** Select the **Write Block Setting** checkbox in the **Read/Write Block Setting** section.
Write Start Addr.: Values are written to D10~D17 in the DVP series PLC.
Read Start Addr.: Values in D10~D17 in TP70P

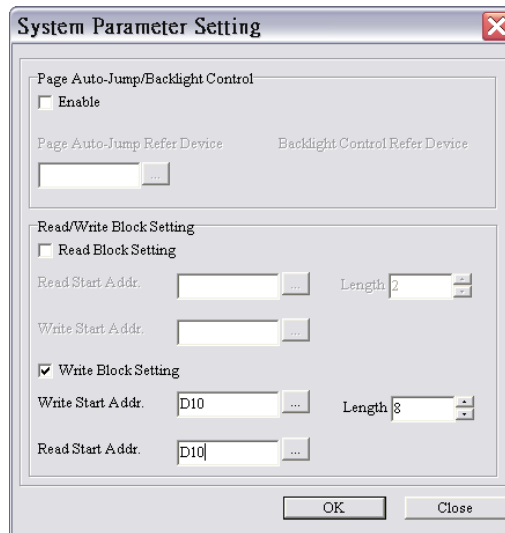

Step 2: Click at the right side of the **Write Start Addr.** box. Select the **External PLC Setting** option button and D10 in the **Refer Device** window.

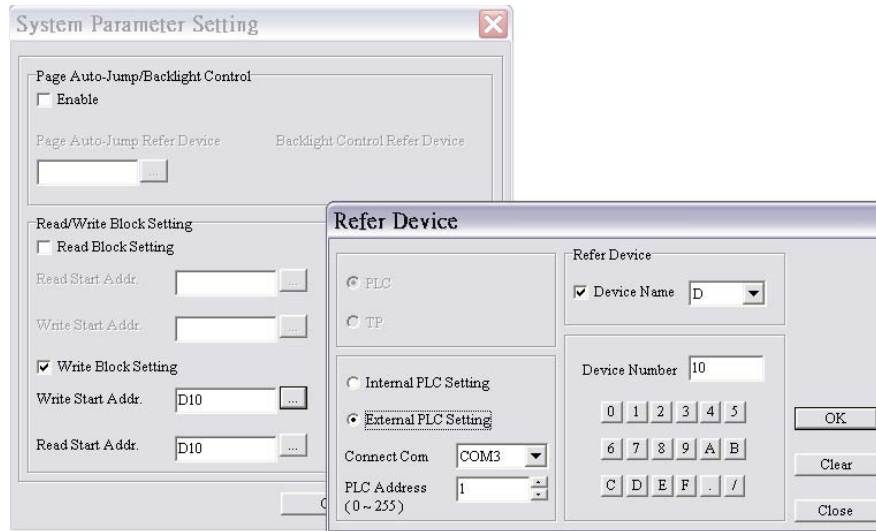

Step 3: After the steps above are complete, and the program in TPEditor is downloaded to TP70P, TP70P can exchange data with the DVP PLC series by means of COM3.

3

MEMO

3